

HITACHI

User's Manual

General Description

S10VE

SEE-1-001 (A)

User's Manual

General Description

SLOVE

If you export this product, please check all restrictions (for example, Japan's Foreign Exchange and Foreign Trade Law, and USA export control laws and regulations), and carry out all required procedures. If you require more information or clarification, please contact your Hitachi sales representative.

Edition 1 (October 2019): SEE-1-001 (A)

- No part of this material may be reproduced in any form or by any means without permission in writing from the publisher.
- Information in this document is subject to change without notice.

For inquiries about this product, please visit the following URL:

<https://www.hitachi.com/s10/>

All Rights Reserved, Copyright © 2019, Hitachi, Ltd.

Safety Precautions

- Before installation, operation, maintenance, and inspection of this product, you must carefully read through this manual and other related manuals. When using the product, make sure that you are familiar with all the information concerning this product, safety information, and precautions provided in those manuals.
- Keep this manual in a readily accessible place for future reference when using the product.
- Safety precautions in this manual are classified into four levels according to the severity of potential hazards: DANGER, WARNING, CAUTION, and Notice.

Definitions of the safety labels



: Indicates a hazardous situation which, if not avoided, will result in death or serious injury.



: Indicates a hazardous situation which, if not avoided, could result in death or serious injury.



: Indicates a hazardous situation which, if not avoided, could result in minor or moderate injury.

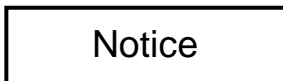

: Indicates a danger (resulting from incorrect use of the product) that can cause property damage or loss not related to personal injury if the safety precautions are not observed.

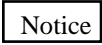
Failure to observe precautions marked with  or  could also lead to a serious consequence depending on the situation in which the product is used. Therefore, you must observe all of those precautions without fail.

The following are definitions of *serious injury*, *minor or moderate injury*, and *property damage or loss not related to personal injury* used in the safety labels.

Serious injury:

Is an injury that has aftereffects and requires hospitalization for medical treatment or long-term follow-up care. Examples of serious injuries are as follows: vision loss, burns (caused by dry heat), low-temperature burns, electric-shock injuries, broken bones, and poisoning.

Minor or moderate injury:

Is an injury that does not require either hospitalization for medical treatment or long-term follow-up care. Examples of minor or moderate injuries include burns and electric-shock injuries.

Property damage or loss not related to personal injury:

Is damage other than personal injury. Examples of property damage or loss not related to personal injury are as follows: damage or loss of personal property, failure or damage of the main unit of the product, and loss of data.

The safety precautions stated in this manual are based on the general rules of safety applicable to this product. These safety precautions are a necessary complement to the various safety measures included in this product. Although they have been considered carefully, the safety precautions posted on this product and in the manual do not cover every possible hazard. Common sense and caution must be used when operating this product. For safe operation and maintenance of this product, establish your own safety rules and regulations according to your specific needs. A variety of industry standards are available to aid in establishing such safety rules and regulations.

1. General Safety Guidelines

Before installing, operating, inspecting, or conducting maintenance on this unit, read the following instructions carefully:

Before starting work

- Follow all the instructions and operating procedures provided in this manual and related manuals.
- Pay particular attention to the cautionary notes in the manuals and on the equipment itself, and comply with their stipulations.
Failure to do so could cause personal injury or damage to the machine.
- Do not perform any operation or action that is not described in this manual. When in doubt, contact the relevant store or your sales staff.
- The hazard warnings on the machine and in the manual cannot cover every possible case, as it is impossible to predict and evaluate all circumstances.
You must be alert and use your common sense.
- Do not perform any installation, wiring, handling, or internal customization that is not described in this manual. Hitachi will not be responsible for any damage to Hitachi equipment or peripherals and personal injury resulting from such a practice.
- In case this product fails, configure an emergency stop circuit or interlock circuit outside the product. Failure of this product might damage the machine or cause an accident.
- Maintenance work must be done only by appropriately trained persons who have practical experience and understand the potential hazards (and how to avoid them) during operation.

 During work

- Follow the sequence of steps specific to each procedure.
- Use the relevant tools and instruments for each task as specified in the manual. If no particular tools are specified, use commercially available tools and instruments which fit the purpose.
- Make sure that all measurement instruments and powered tools have been properly calibrated or periodically inspected prior to use.
- Keep the maintenance area neat and tidy.
- Make sure that maintenance parts, materials, and removed parts are not placed in a passageway so they are not tripped on by personnel.
- Wear eye protection if there is a risk of flying debris.
- When using sharp objects or cutting tools, keep fingers and other parts of your body away from the path of the blade bit or point.
- After maintenance work is completed, before turning on power, make sure that all parts removed during maintenance have been installed back in their original positions in the machine. Also make sure that no tool or foreign material remains in the machine.



Prevention of electric shock

- Before starting work, make sure that there is no potential electrical hazard in the maintenance area.
Example: Insufficient grounding line or a wet floor
- Before starting work, check the location of the emergency power-off switches and how to operate them.
- Unless otherwise specifically instructed, isolate the machine from all power sources before starting maintenance. Turn off not only the power switches on the machine but also the switch on the distribution panel.
After turning off the switch on the power distribution panel, attach a notice saying *Do not turn on this switch* on the power distribution panel. If the power distribution panel is equipped with a lockout device, turn off the switch on the power distribution panel, lock the device, and then bring the key with you.
If you are resuming maintenance work performed by someone else, do not assume that the power is off. Make sure that the above-mentioned conditions, such as switches turned off, are satisfied. If necessary, use a measurement tool to ensure that the power is off.
- Some parts in the machine remain charged for a certain time even after the power supply to the machine is disconnected. (Follow the displayed instructions).
- When working on a machine which has a grounding terminal, make sure that the terminal is properly connected to the facility's ground.
- When working near an exposed live electric circuit, do not work alone. Work with another person who can immediately turn off the power.
- To prevent electric shock during work, do not wear any metallic items or an accessory such as a wristwatch with a metallic surface. If you wear eyeglasses with a metallic frame, take care not to let the frame touch an uninsulated surface.
- Make sure that your hands and arms are dry.
- Use only one hand when it is necessary to work near an exposed live electric circuit. This mitigates the risk of current passing through your heart if you accidentally touch the circuit.
- Do not use a dental mirror near an exposed live electric circuit. The mirror surface is conductive and can become hazardous even if the mirror is made of plastic.
- Unless otherwise specifically instructed, do not supply power to any subassembly such as a power supply unit or a motor while it is removed from the machine.



Procedure in an emergency

In the case of electric shock

- Do not panic. Do not become another victim through contact with the injured person.
- First, shut off the electric current passing through the victim by using the emergency power-off switch. If there is no emergency power-off switch, use the normal power-off switch.
If this cannot be done, push the victim away from the source of the electric current by using a nonconductive object such as a dry wooden stick.
- Call an ambulance.
- If the victim is unconscious, artificial respiration may be necessary.
A proper method for performing artificial respiration or resuscitation should be learned beforehand.
If the victim's heart is not beating, cardio-pulmonary resuscitation must be performed by a trained and qualified person.



In the case of fire

- Call the fire department, and then take action to extinguish the fire.
- Shut off power to the machine by using the emergency power-off switch. If there is no emergency power-off switch, use the normal power-off switch.

2. Notes About Warning Indications

The following summarizes the warnings contained in this manual and their locations.

2.1 DANGER

 DANGER
<ul style="list-style-type: none">• Electric shock might cause death. Make sure that the protective grounding terminal () is connected to the ground. <p style="text-align: right;">(See page 7-11.)</p>

2.2 WARNING

 WARNING
<ul style="list-style-type: none">• The S10VE is an open-type device. To avoid electric shock, make sure to install it in an enclosure.<p style="text-align: right;">(See page 1-1.)</p>• To prevent an accident or equipment damage, you must configure an emergency stop circuit external to this product.• Overcurrent or overvoltage might damage components, resulting in an accident, fire, or damage to equipment. Do not exceed the rated maximum input or output current or input voltage values of the PI/O modules.• Removing or installing modules with the power supply module turned on might cause electric shock or accident. Turn off the power supply module before performing these tasks.• Check the wiring carefully before turning on the system. Improper wiring can result in electric shock or fire.• Incorrect use of the system can lead to accidents and equipment damage. Check the safety of peripheral equipment before modifying a running program or performing RUN or STOP operations.<p style="text-align: right;">(See page 1-5.)</p>• To avoid electric shock, take the following precautions:<ul style="list-style-type: none">- Do not touch the power supply terminals while input power is present.- Before wiring the power supply, make sure that no voltage is applied to the power cable.- Attach the terminal cover as soon as you finish wiring the power supply.- To prevent your fingers from touching conductive parts, use solderless terminals with insulating covers.<p style="text-align: right;">(See page 5-4.)</p>• To avoid accident or electric shock, turn off the power switch on the power supply module before removing or installing a module.<p style="text-align: right;">(See pages 6-8, 14-10, 14-13, 14-16, 14-19, 14-22, 14-25 and 14-27.)</p>



WARNING

- Do not put the primary battery cables between the primary battery cover and the CPU module. Doing so might result in shorting due to disconnection, causing deformation, leakage, heat generation, explosion, or fire.

(See pages 6-9 and 14-8.)

- To avoid electric shock, accident, or malfunction, make sure that the power switch of the power supply module is off before connecting or disconnecting any cables. Re-attach the terminal cover as soon as you have completed the wiring.

(See page 7-11.)

- To avoid fire, place fuses on both sides of the AC power supply. This protects the system if the PCsOK or COM line shorts to FG.

(See page 7-12.)

- To avoid fire, place fuses on both sides of the AC power supply. This protects the system if the RI/O STOP (or STOP/RUN) or COM line shorts to FG.

(See page 7-13.)

- To avoid electric shock, do not touch the terminal block terminals or connector pins while the power is on.

- To avoid electric shock and fire, wiring must be carried out by a person with practical experience who has undergone the appropriate training and is able to recognize the hazards presented by the work.

- To avoid electric shock, accident, or malfunction, make sure that the power switch of the power supply module is off before connecting or disconnecting any cables. Re-attach the terminal cover as soon as you have completed the wiring.

- To avoid electric shock and fire, check the wiring carefully before turning on the power.

(See page 7-19.)

- To avoid electric shock, turn off the switch at the AC/DC power source (the MCCB or FFB, for example) before removing or installing a power supply module.

- To avoid electric shock, do not touch the pins on the power supply input terminal block.

(See page 14-1.)



WARNING

- Do not allow the primary battery to be swallowed. Keep the battery out of reach of infants and children. If the primary battery is inadvertently swallowed, immediately consult a physician.
- Do not attempt to charge the primary battery. Attempting to charge the battery can result in gas generation or internal shorting, causing such issues as deformation, leakage, heat generation, explosion, or fire.
- Do not heat the primary battery. If the battery is heated to a temperature of 100°C or higher, the internal pressure of the battery rises, causing such issues as deformation, leakage, heat generation, explosion, or fire.
- Do not place the primary battery in a fire. If you do so, the metallic lithium will melt, causing the battery to explode or catch fire.
- Do not disassemble or bend the primary battery. Doing so can damage the insulating material, internal structure, or other aspect of the battery, causing such issues as deformation, leakage, heat generation, explosion, or fire.
- Take care not to insert the primary battery in the device upside down. Doing so can cause an abnormal reaction such as charging or shorting of the battery, which can lead to issues like deformation, leakage, heat generation, explosion, or fire.
- Do not allow a wire or other metallic object to contact the plus and minus terminals of the primary battery. Also, do not store or carry the battery with a necklace, hairpin, or other metal object that might cause such a connection to occur. Do not remove multiple batteries from their packaging and store them stacked together. If the primary battery shorts out, a significant overcurrent might flow, causing such issues as deformation, leakage, heat generation, explosion, or fire.
- Do not directly solder terminals or wires to the primary battery. The applied temperature can damage the insulation or internal structure of the battery, causing such issues as deformation, leakage, heat generation, explosion, or fire.
- Do not touch any liquid that has leaked from the primary battery. If the liquid contacts your eyes, it can cause eye damage. If such contact occurs, flush your eyes thoroughly with plenty of water from the faucet or another clean source, and immediately seek medical treatment. Do not rub your eyes. If the liquid enters your mouth or adheres to your lips, gargle with plenty of water from the faucet or another clean source, and consult a physician.
- Keep any liquids associated with the primary battery away from fire. If the battery is bent, leaking liquid, or producing an unusual odor, the electrolytic solution that leaks from the battery has the potential to ignite. Remove the battery from any source of fire.
- Do not keep the primary battery in prolonged contact with skin. Skin damage might result if tape or other means is used to achieve prolonged skin contact.
- Do not use primary batteries other than those specified by Hitachi. Use of other primary batteries can cause abnormal current to flow, causing damage to the primary battery or CPU module, or resulting in heat generation, smoke, explosion, or fire.

(See page 14-6.)



WARNING

- Shorting the battery terminals is dangerous even for a drained battery. A short circuit might occur if contact is made between the plus and minus terminals, or the battery contacts a piece of metal. When disposing of primary batteries, use insulating tape to wrap each battery as shown in the following example. Having done so, dispose of the battery as industrial waste.

Example of battery insulation:

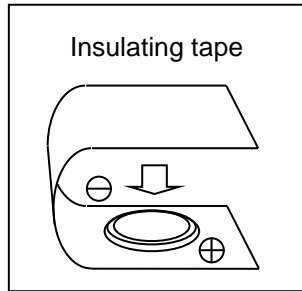

(See page 14-7.)

- To avoid electric shock, turn off the power supply on the facility side that is connected to the PI/O module before removing or mounting the module.

(See page 14-25.)

2.3 CAUTION

CAUTION

- Do not insert a finger or foreign object into the gap between a connector and the mount base. Doing so might lead to injury or cause the system to malfunction.
- To avoid fire, use an external power supply with an overvoltage and overcurrent protection function.
- To avoid fire, if you see smoke or smell an unusual odor, turn off the power immediately and investigate the source.
- Do not obstruct the ventilation slots at the top and bottom of the modules. Doing so might cause smoke or fire, or lead to module failure or malfunction.
- The modules have open ventilation slots at the top and bottom. To avoid smoke, fire, and module failure or malfunction, take the necessary measures to prevent objects from falling into the slots.
(See page 1-5.)
- Do not insert a finger or foreign object into the gap between a connector and the mount base. Doing so might lead to injury or cause the system to malfunction.
- Do not attach the mount base to the cabinet with modules already attached to the mount base. Doing so might cause injury or module damage as a result of a module being dropped.
(See page 6-6.)
- Make sure that the screws are securely tightened. Failing to do so can cause smoke, fire, or malfunction, or cause the module to fall.
(See pages 6-8 and 12-3.)
- Do not allow ultrasonic wave vibration near the primary battery. Ultrasonic wave vibration can pulverize its contents, causing an internal short. This can lead to issues as deformation, leakage, heat generation, explosion, or fire.
- Do not handle the primary battery roughly. Do not drop the battery, subject it to shock, or cause it to deform. This can cause deformation, leakage, heat generation, explosion, or fire.
- Take care to avoid shorting the primary battery when inserting it into the device. Some devices might have metal parts near where the battery is inserted, which can come into contact with the plus and minus terminal of the battery.
- Do not use or leave the primary battery in direct sunlight, in a hot car, or any other location that experiences high temperatures. This can cause deformation, leakage, heat generation, explosion, or fire.
- Do not allow the primary battery to get wet. This can cause deformation, leakage, heat generation, explosion, or fire. It can also cause the battery to rust.
- Do not store the primary battery anywhere hot or humid. Doing so can reduce the performance or service life of the battery. In some circumstances, it can also cause deformation, leakage, heat generation, or explosion.
(See page 14-7.)

2.4 Notice

Notice

- There is a potential for failure if PCs are not installed in a waterproof cabinet.
- Static electricity might damage a module or cause it to malfunction. Discharge any static electricity from your body before touching the equipment.
- The system is not designed to withstand constant vibration or shock. If the system is installed in a location subject to such conditions, isolate the system from sources of vibration or shock, or take anti-vibration measures such as the use of anti-vibration rubber mounts.

(See page 1-1.)

- The cabinet in which the CPU and PI/O modules of the S10VE are mounted must have ventilation holes in the door and top panel, or have a fan installed in the door. To improve airflow within the cabinet, make sure that there are gaps at the top, bottom, and sides of each mount base. Failing to provide these gaps might lead to module failure or malfunction.
- To avoid failure and malfunction, consider the following measures during installation design to ensure that the intake air temperature at the center of the base of the power supply module and CPU modules does not exceed 55°C:
 - Make sure there is plenty of space between a unit and those above and below it
 - Use a fan to perform forced air cooling
 - Install a waste heat duct
 - Install a cooler for the control panel
- To prevent equipment damage during transport, protect the equipment with cushioning material and transport it as you would a precision instrument.

(See page 1-5.)

Notice

- In remote I/O communication, there is no way to view error information besides checking the system register and looking at the LED indicators on the station module and remote I/O optical adapter. There is no way to determine from the contents of the received data whether the data was transmitted normally or a time out occurred. This means that in a large-scale or wide area system that has been built using remote I/O optical adapters, it takes a long time to analyze the cause when an issue arises. Because the system register and LED indicators provide current status information, the operator can identify the source of a persistent error, such as that caused by a failed module. However, identifying the source of an error that manifests intermittently such as a partial cable disconnection takes much more time. Given this difficulty in identifying the source of errors related to remote I/O communication, you must keep the following in mind with the objective of streamlining the process of failure analysis when a failure occurs:

A module such as OD.RING makes it easier to analyze faults on a line. Consider using it in your system design where doing so is cost-effective.

- Design the system in a way that considers fault analysis, through such means as centralized installation and PI/O unit aggregation.
 - Prepare an allocation table that shows the correspondence of I/O signals and PI/O addresses with respect to the entire system configuration. This allows you to identify the location of the fault when an issue with data occurs at the application level, such as data not being updated due to a timeout.
 - The CPU module of the S10VE system does not perform external notification if the remote I/O line times out. It is the responsibility of the user to use a program that monitors the system register at the control cycle level and identifies when a timeout occurs.
 - To identify the source of an intermittent fault, it is the responsibility of the user to use a program that saves to memory all areas of the system register related to the remote I/O line when a timeout occurs.
 - Tag each optical cable with its line number to prevent incorrect connection of the remote I/O optical adapter and optical cables.
- If multiple remote I/O optical adapters are installed together, turning off the power supply module of the CPU unit for maintenance of the remote I/O optical adapter prevents any further remote I/O communication that involves the remote I/O optical adapters. When designing the system, consider your maintenance procedures when implementing remote I/O optical adapters.

(See pages 2-4 and 13-87.)

- To prevent damage to the power supply module, take the following precautions:
 - Leave sufficient time (at least 5 seconds) between turning the power switch off and on.
 - Do not repeatedly turn the power switch on and off.
 - Input voltage must increase and decrease monotonically between 0 and 85V.
 - Do not supply a fluctuating input voltage that might cause the power supply module to repeatedly start and stop.

(See page 5-4.)

Notice

- If the environment does not meet the conditions for grounding to the steel frame of the building, drive a grounding rod in the earth near the PCs panel that provides a low grounding resistance. This prevents surrounding noise from entering the PCs and prevents equipment from failing or malfunctioning.

Conditions for grounding to steel frame of building:

- The steel frame is welded together.
- The grounding between the earth and the steel frame meets the criteria for class D.
- To prevent AC current from entering the grounding point of the PCs panel, the grounding point connects to a different main line from the AC panel, separated by a distance of at least 15 m.

(See page 6-1.)

- To avoid failure or malfunction, leave clearance of at least 100 mm between the cabinet (top and bottom panels) and unit, and between each unit. If you are unable to provide 100 mm of clearance, make sure that the intake air temperature will not exceed 55°C.
- To avoid failure or malfunction, leave clearance of at least 50 mm between the cabinet (side panels) and units. If you are unable to provide 50 mm of clearance, make sure that the intake air temperature will not exceed 55°C.

(See page 6-4.)

- Secure the mount base to the upright surface inside the cabinet. The rise in temperature that occurs when the mount base is attached anywhere else can damage or degrade the equipment.
- To avoid malfunction, do not remove the insulating bushes that insulate the mount base from the cabinet. Confirm that the structure does not allow the metallic part of the mount base to contact the control panel.
- The system is not designed to withstand constant vibration or shock. If the system is installed in a location subject to such conditions, isolate the system from sources of vibration or shock, or take anti-vibration measures such as the use of anti-vibration rubber mounts.

(See page 6-6.)

Notice

- Static electricity might damage a module or cause it to malfunction. Discharge any static electricity from your body before touching any equipment.
- Poor contact might cause malfunction. Mount the module and connect cabling to the module immediately after the module is unpacked so that dust or other foreign substances do not accumulate on connectors.
- To avoid damaging a module when removing or mounting it, turn off the power switch of the power supply module beforehand.
- To avoid damaging a module, observe the following precautions when mounting or removing the module:
 - Before mounting the module on the mount base connector, check that the connector pins are properly aligned and not bent, broken, or soiled.
 - Connecting or disconnecting a module that is tilted might damage connector pins. When moving the module, hold it vertically parallel to the mount base as shown below.

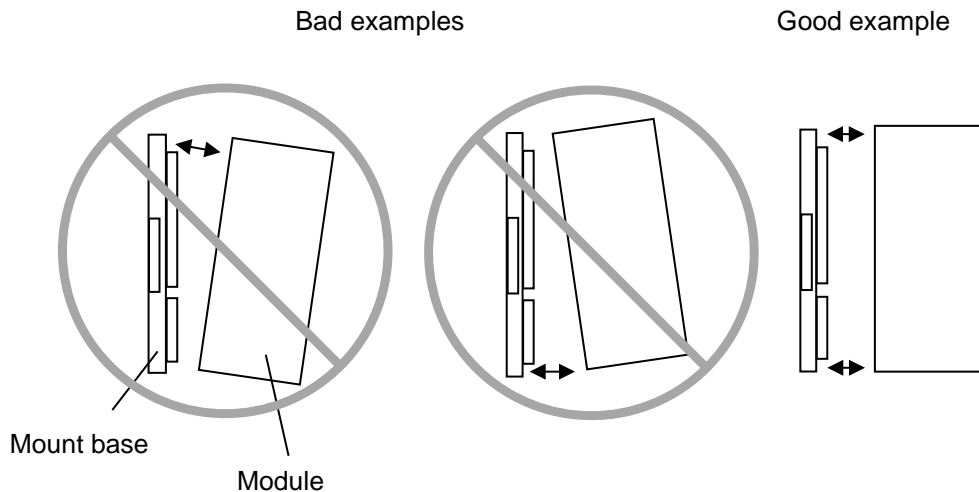

(See page 6-8.)

- Mounting a module to the wrong slot can damage the equipment. Mount the power supply module, CPU module, and RI/O-IF module to its dedicated slot and no other.

(See page 6-10.)

- Failing to observe the PI/O module mounting restrictions can lead to malfunction.

(See page 6-13.)

Notice

- The grounding system of the CPU unit differs from that of the PI/O unit. To avoid malfunction or damage to a module, confirm that the wiring is correct.

(See page 7-8.)

- Noise can cause the system to malfunction. Make sure that the protective grounding terminal (\oplus) is grounded.
- To avoid malfunction, the mount base must be insulated from the cabinet. Do not remove the insulating bushes from behind the mount base.
- Connect the FG terminals of adjacent modules and mount base in a daisy chain, and then connect the end of the daisy chain to the FG terminal of the power supply module.
- Do not connect the FG terminal of a module to a mount base fixing screw.

(See page 7-9.)

- To avoid malfunction, set a terminating resistance (150Ω) at any RI/O-IF module ports to which a remote I/O cable will not be connected. This prevents external noise from entering the system.

(See pages 7-14 and 7-15.)

- Noise can cause malfunction. Do not harness the wiring for 100 V AC or 100 V DC power together with network cables. There must be at least 100 mm separation between the two types of cabling.
- To protect from short circuits, provide fuses or circuit protectors in any external power source. Use a circuit protector that is appropriate for the rating of the system.
- Surge voltage can cause equipment damage or malfunction. If you connect a coil (such as a relay) to the PCsOK output circuit, you must also provide a surge absorption diode or other means to protect from surge voltage. This diode must withstand reverse voltage of at least 10 times the circuit voltage, and a forward current matching or exceeding the load current.
- Noise can cause the equipment to malfunction. Keep each type of cable, such as communication cables, power cables, and lead cables separated when wiring the system. It is of particular importance that lead cables such as those for inverters, motors, and power regulators are separated from other cables by at least 300 mm. Furthermore, communication cables must travel through different conduits and ducts from lead cables.
- Static electricity might damage a module or cause it to malfunction. Discharge any static electricity from your body before touching the equipment.
- To avoid malfunction, set a terminating resistance (150Ω) at any RI/O-IF module ports to which a remote I/O cable will not be connected. This prevents external noise from entering the system.

(See page 7-19.)

Notice

- Use an account with administrator privileges to install and uninstall the S10VE tools. If you use a standard account, the tools might not be installed or uninstalled correctly.
- Exit all Windows® programs before installing each tool. This includes memory-resident programs such as anti-virus software. An error might occur if you attempt to install a tool with other programs still running. In this case, uninstall the tool you were installing and exit all Windows® programs. Then, install the tool again. For details on how to uninstall a tool, see 8.2.3.3 *Uninstalling individual tools*.
- Do not install an S10VE tool to any of the following folders, which are protected by User Account Control:
 - Program file folder (for example, C:\Program Files)
 - System root folder (for example, C:\Windows)
 - System drive root folder (for example, C:\)
 - Program data folder (for example, C:\ProgramData)

(See page 8-5.)

- BASE SYSTEM/S10VE cannot be installed on a per-user basis. To install BASE SYSTEM/S10VE successfully, you must first log on to the system with an administrator account. BASE SYSTEM/S10VE might not be installed properly in any of the following cases: 1) Administrator permissions are acquired by using User Account Control[#] from a standard user account, 2) The administrator account was created from a standard user account by using User Account Control. In this case, log on with the administrator account that was first created on your PADT, and then reinstall BASE SYSTEM/S10VE. If you log on with a user account other than that used for installing BASE SYSTEM/S10VE, the installed program might not appear in the program menu. In this case, log off and log on again with the administrator account that was first created on your PADT, uninstall the installed program, and then install the program again. When you want to create a new account, log on with an administrator account without using User Account Control.

[#]: User Account Control is a Microsoft Windows feature that temporarily grants administrative rights to standard user accounts.

(See pages 8-7 and C-9.)

- You cannot log on using multiple user accounts and switch between them without logging off. You must log off before you can switch to another user account.

(See pages 8-22 and 8-29.)

Notice

- Do not restore backup data that the data comparison found to be inconsistent. Doing so can cause the system to malfunction.

(See page 8-125.)

- To avoid malfunction, do not place the CPU module in RUN mode if the data comparison has found the data to be inconsistent. In this case, perform the restoration process again, and do not turn the system on and off again until the issue is resolved.

(See page 8-132.)

- The aluminum electrolytic capacitors in the power supply module (LQV410) have a limited lifespan. We recommend that you replace the power supply module within 10 years.

The service life of the aluminum electrolytic capacitors is approximately 10 years at an ambient temperature of 35°C. The service life halves with every 10°C increase in ambient temperature.

When keeping a spare power supply module in long-term storage, store it in an environment with a temperature from 15°C to 40°C and humidity of 65% or less.

(See page 12-1.)

- Static electricity might damage a module or cause it to malfunction. Discharge any static electricity from your body before touching the equipment.

(See pages 12-3, 14-10, 14-13, 14-16, 14-19, 14-22, 14-25 and 14-27.)

- Take care to tighten the screws securely. Failing to do so can result in the system stopping or malfunctioning, or cause a module to fall.

- To avoid malfunction, make sure that each module is subjected to a run-in process before installation.

(See page 14-1.)

- After replacing the primary battery, set the system time again.

(See page 14-7.)

- If you disconnect optical fiber cables from multiple modules at once, communication might be interrupted. Replace one module at a time.

- If you disconnect an optical fiber cable to replace a module while the ring is broken, communication will no longer be possible. Before replacing a module, look up the module RAS table and make sure that the ring is not broken.

- During module replacement, a disconnection will be detected and shown in the RAS table. However, communication will still take place as normal between the OD.RING modules in other units.

(See page 14-10.)

Notice

- Each module uses components containing gallium arsenide (GaAs). Because gallium arsenide is legally defined as a hazardous substance, take particular care with its disposal. When disposing of a module, it must be disposed of as industrial waste by professionals.
- Dispose of primary batteries according to your local laws and regulations with the assistance of waste disposal professionals.

(See page 14-29.)

- Use an account with administrator privileges to install and uninstall the S10VE tools. If you use a standard account, the tools might not be installed or uninstalled correctly.
- Exit all Windows® programs before installing each tool. This includes memory-resident programs such as anti-virus software. An error might occur if you attempt to install a tool with other programs still running. In this case, uninstall the tool you were installing and exit all Windows® programs. Then, install the tool again. For details on how to uninstall a tool, see *C.5 Uninstalling software products*.
- Do not install an S10VE tool to any of the following folders, which are protected by User Account Control:
 - Program file folder (for example, C:\Program Files)
 - System root folder (for example, C:\Windows)
 - System drive root folder (for example, C:\)
 - Program data folder (for example, C:\ProgramData)

(See page C-2.)

3. Location of warning labels on modules

The following shows where on each module the warning labels are located, and what they tell you.

Power supply module (LQV410)

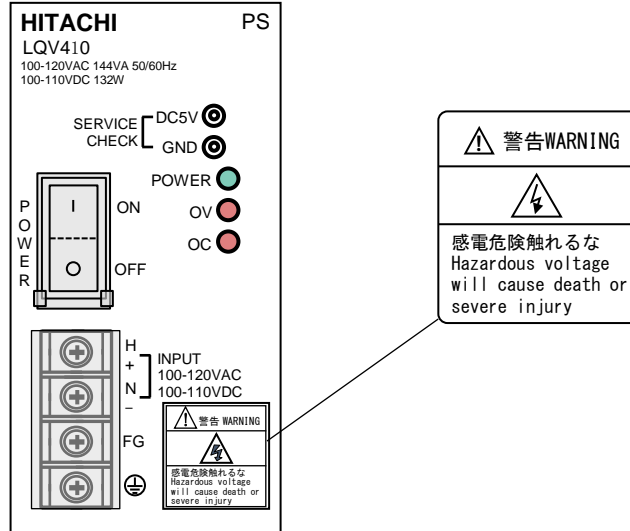

CPU module (LQP600)

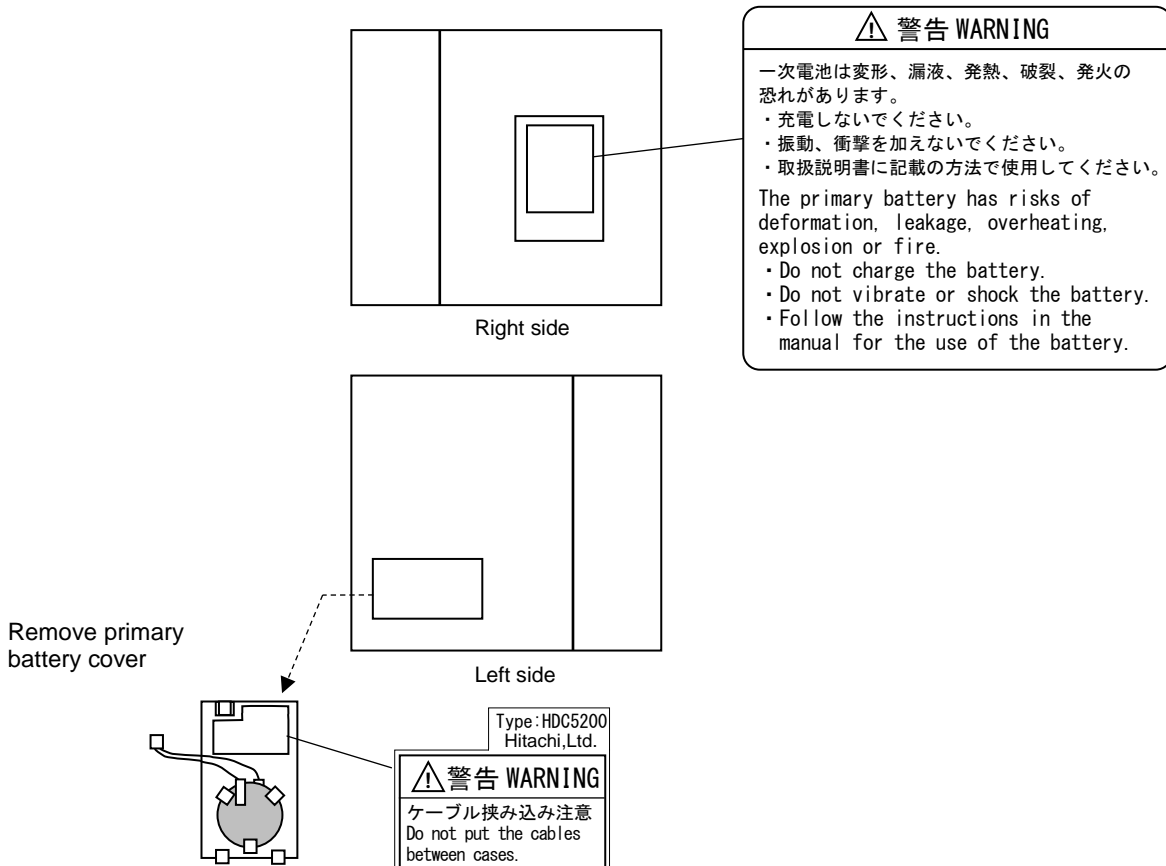

RI/O-IF module (LQE950)

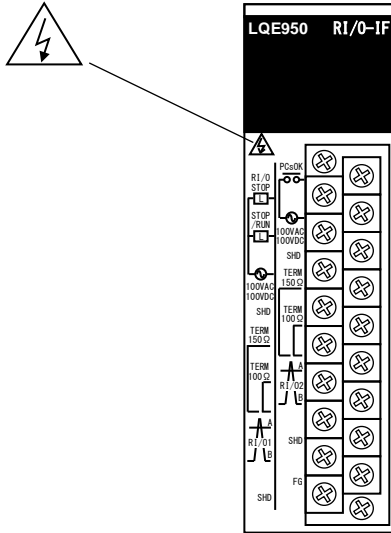

Application Conditions

- When using the product explained in this manual (called *this product* hereafter), we ask you to provide a backup or fail-safe system outside the product so that any failure or problem in this product will not cause serious consequences.
- This product is a general-purpose product designed for general industrial applications. This product shall not be used in applications that require a high level of safety or responsibility or special quality assurance. Hitachi assumes no responsibility for any loss or damage arising from the use of this product in such applications. Examples of such applications are as follows:

Applications where a high level of safety is required

Example: Power station control system (nuclear power, thermal power, or hydro power), combustion facility, aviation or space facility, railway facility, lift facility, facility for recreation and amusement, medical facility, safety equipment, on-vehicle equipment, ship facility, traffic light system, and other facilities where death or bodily harm might result in the event of an emergency

Applications where a high level of responsibility is required

Example: Systems that supply gas, water, or electricity, systems requiring round-the-clock operation, system responsible for legal settlement or other purpose of handling rights and properties

Applications under severe conditions or environment

Example: Outdoor facility environment that meets any of the following conditions:
Environment that is chemically contaminated, subject to electromagnetic interference, or subject to constant vibration or shock

However, use of this produce in any of the applications described above can be approved by the decision of Hitachi if the purpose is specifically limited, the customer has responsibility for providing redundancy, or no special quality is required. For details, contact a Hitachi sales representative.

Warranty and Servicing

1. Warranty period and scope

Warranty period

The warranty period of this product shall be one year after the product has been delivered to the specified site. The warranty period of repaired products shall be six months from the date of repair. The warranty period for repaired products takes precedence over the warranty period prior to repair.

Scope

If the product malfunctions during the warranty period described above while using this product as instructed by this manual, the product shall be repaired free of charge.

Repair service

Return repair is supported, and requires the customer to send the malfunctioning product to a designated repair service.

- Fill in the required items in the *Hitachi Programmable Controller S10VE Repair Request Sheet* in *Appendix A* in the *S10VE User's Manual General Description* (manual number SEE-1-001), and then enclose it in the package with the product to be returned for repair.
- The customer must cover the costs for sending the product for repair to Hitachi.
- Hitachi will pay the transport cost for returning the repaired product to the customer.
- Repair is limited to replacement of malfunctioning parts.
- Work other than replacement of malfunctioning parts, such as investigation into the cause of failure, shall be charged even during the warranty period.

2. Exception of warranty obligation

Regardless of the warranty period, Hitachi bears no responsibility in any of the following cases.

The warranty mentioned here means the warranty for the individual product that is delivered. Therefore, we cannot be held responsible for any losses or lost profits that result from operation of this product or from malfunctions of this product. This warranty is valid only in Japan and is not transferable.

- The malfunction was caused by handling or use of the product in a manner not specified in the product specifications.
- The malfunction was caused by a unit other than that which was delivered.
- The malfunction was caused by modifications or repairs made by a vendor other than the vendor that delivered the unit.
- The malfunction was caused by a relay or other consumable which has passed the end of its service life.
- The malfunction was caused by a disaster, natural or otherwise, for which the vendor is not responsible.
- The malfunction was caused by reasons that could not be anticipated, based on conventional technological understanding, at the time of shipment from Hitachi.

3. Range of services

The price of the delivered product does not include on-site servicing fees by engineers. Extra fees will be charged for the following:

- Instruction for installation and adjustments, and witnessing trial operations
- Inspections, maintenance, and adjustments
- Technical instruction, technical training, and training facilities
- Examinations and repairs after the warranty period expires
- Examination of malfunctions caused by reasons outside the scope of the preceding warranty

4. Repair acceptance period

The repair acceptance period of S10VE products is 10 years after the product is delivered to the specified site or 7 years after production of the product is stopped, whichever comes earlier. The standard service life of S10VE is 10 years. We cannot accept repair of products whose designated repair acceptance periods (as described here) have been exceeded.

Payment for any repair after expiration of the warranty is the responsibility of the customer.

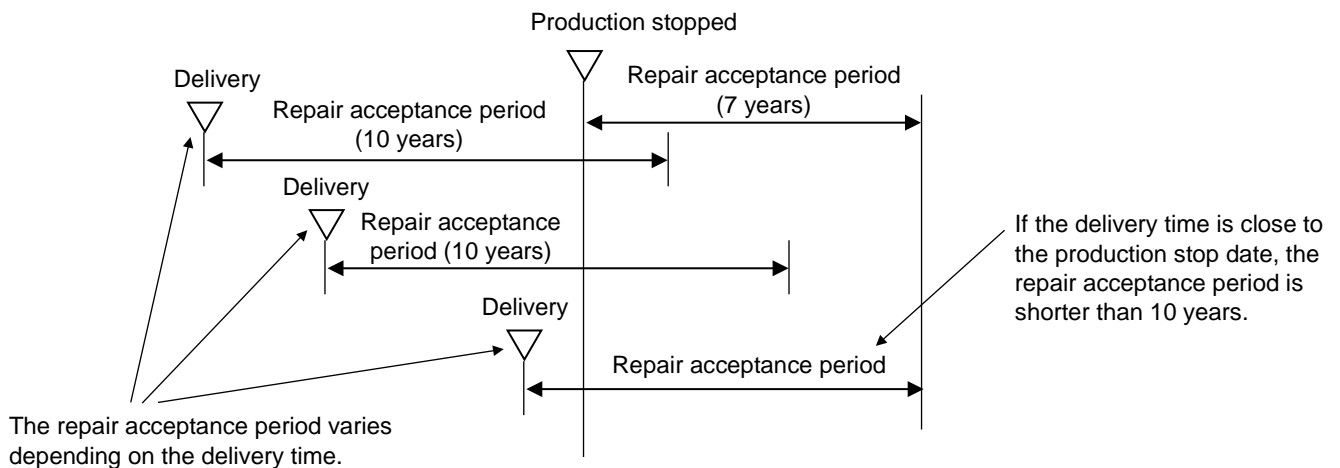

5. Service after production of the product is stopped

Products (including spare parts) cannot be supplied after production of those products is stopped.

6. Specification changes

Specifications described in this manual are subject to change without prior notice.

Revision History

Revision No.	History (revision details)	Issue date	Remarks
A	New edition	Oct. 2019	

Preface

This manual explains how to use the basic modules of the S10VE system. The PI/O modules, option modules, and software are described in other manuals. Read each manual thoroughly to familiarize yourself with all aspects of the system.

This manual is organized into the following chapters and appendixes:

Organization of this manual

1. Usage Notes

This chapter presents cautionary notes that apply when using the S10VE system.

2. Overview

This chapter explains the configuration of the S10VE system, and the individual components that make up the system.

3. Specifications

This chapter explains the general specifications of the S10VE system, and the key specifications of the individual modules.

4. Using the S10VE System

This chapter lists the procedures related to use of the S10VE system, and points to where in this manual each procedure is explained.

5. Part Names and Functions

This chapter explains the name and function of each part of the S10VE system, and describes its external dimensions.

6. Installation

This chapter explains how to install the S10VE equipment in the panel, and how to install modules in the S10VE system.

7. Wiring

This chapter explains how to connect S10VE to earth, how to wire the cables, and the cable specifications.

8. Tools

This chapter explains how to use the tools provided with the S10VE system.

9. Settings

This chapter explains how to set up the hardware and software associated with the S10VE system.

10. Indicator

This chapter explains the information displayed by the S10VE indicator, and how to use the switches to navigate the menu.

11. Operation

This chapter explains the operation of the S10VE system.

12. Inspection

This chapter explains the replacement cycle of limited-life components used in the S10VE system, and the process of regular inspections.

13. Troubleshooting

This chapter explains how to analyze the cause of errors that occur in the S10VE system, and the remedial action that needs to be taken.

14. Adding and Replacing Modules

This chapter explains how to replace and add modules in the S10VE system.

Trademarks

- Microsoft® and Windows® are either registered trademarks or trademarks of Microsoft Corporation in the United States and/or other countries.
- Ethernet is a registered trademark of Fuji Xerox Co., Ltd.

Other company and product names mentioned in this document may be the trademarks or registered trademarks of their respective owners.

This manual sometimes omits the ® or ™ symbol.

Note about storage capacity calculations

- Memory capacities and requirements, file sizes and storage requirements must be calculated according to the formula 2^n . The following examples show the results of such calculations by 2^n (to the right of the equal signs).
 - 1 KB (kilobyte) = 1,024 bytes
 - 1 MB (megabyte) = 1,048,576 bytes
 - 1 GB (gigabyte) = 1,073,741,824 bytes
 - 1 TB (terabyte) = 1,099,511,627,776 bytes
- As for disk capacities, they must be calculated using the formula 10^n . Listed below are the results of calculating the above example capacities using 10^n in place of 2^n .
 - 1 KB (kilobyte) = 1,000 bytes
 - 1 MB (megabyte) = 1,000² bytes
 - 1 GB (gigabyte) = 1,000³ bytes
 - 1 TB (terabyte) = 1,000⁴ bytes

Related manuals

Manual number	Manual name
SEE-1-001	S10VE User's Manual General Description
SEE-1-101	S10VE User's Manual Option OD.RING (LQE510-E)
SEE-1-102	S10VE User's Manual Option J.NET (LQE540-E)
SEE-1-103	S10VE User's Manual Option D.NET (LQE770-E)
SEE-1-104	S10VE User's Manual Option FL.NET (LQE702-E)
SEE-1-105	S10VE User's Manual Option ET.NET (LQE260-E)
SEE-3-121	S10VE Software Manual Programming Ladder Diagram System for Windows®
SEE-3-122	S10VE Software Manual Programming HI-FLOW for Windows®
SEE-3-131	S10VE Software Manual Operation Ladder Diagram System for Windows®
SEE-3-132	S10VE Software Manual Operation HI-FLOW for Windows®
SEE-3-133	S10VE Software Manual Operation RPD P for Windows®
SEE-3-134	S10VE Software Manual Operation NXACP For Windows®
SEE-3-137	S10VE Software Manual Operation NXTTOOLS SYSTEM For Windows®
SEE-3-201	S10VE Software Manual CPMS General Description and Macro Specifications
SME-1-114	S10mini Hardware Manual I/O Modules
SME-1-119	S10mini Hardware Manual D.Station
SME-1-126	HSC-2100 Hardware Manual I/O Modules
SME-1-120	S10mini Hardware Manual OPT.D-NET

Glossary

Term	Meaning
PCs	An abbreviation for <u>P</u> rogrammable <u>C</u> ontrollers.
PS	An abbreviation for <u>P</u> ower <u>S</u> upply.
CPU	An abbreviation for <u>C</u> entral <u>P</u> rocessing <u>U</u> nit.
Remote I/O	An abbreviation for <u>R</u> emote <u>I</u> nput/ <u>O</u> utput.
RI/O-IF	An abbreviation for <u>R</u> emote <u>I</u> nput/ <u>O</u> utput - <u>I</u> nter <u>F</u> ace.
OD.RING	An optical duplex ring module that performs memory transfer between CPU units.
J.NET	A module that complies with the Programmable Controllers - Field Network Standard (level 1) defined by JEMA.
D.NET	A module that complies with the DeviceNet standard.
FL.NET	A module that complies with the FL-net standard.
ET.NET	A module that provides TCP/IP or UDP/IP protocol communication that conforms to the IEEE802.3i (10BASE-T) or IEEE802.3u (100BASE-TX) specification.
PI/O	An abbreviation for <u>P</u> rocess <u>I</u> nput/ <u>O</u> utput. S10VE supports HSC-1000 and HSC-2100 PI/O.
RAS	An abbreviation for <u>R</u> eliability <u>A</u> vailability <u>S</u> erviceability.
MCS	An abbreviation for <u>M</u> an-machine <u>C</u> ommunication <u>S</u> ystem. MCS is a collective term for functionality that supports the reading and writing of memory contents in the S10VE.
DHP	An abbreviation for <u>D</u> ebugging <u>H</u> elper. DHP records instances passing certain processing points.
BASE SYSTEM/S10VE	A tool for performing various tasks in relation to the S10VE system. For example, you can use BASE SYSTEM/S10VE to construct a system, perform various settings, view RAS information, and monitor and debug the system.
LADDER DIAGRAM SYSTEM/S10VE	A tool for creating, modifying, monitoring, and debugging ladder programs that run on the S10VE.
HI-FLOW SYSTEM/S10VE	A tool for creating, modifying, monitoring, and debugging HI-FLOW application programs that run on the S10VE.
BACKUP RESTORE SYSTEM/S10VE	A tool for backing up and restoring data on the CPU module.
PADT	An abbreviation for <u>P</u> rogramming <u>A</u> nd <u>D</u> ebugging <u>T</u> ools. The PADT is the PC that runs BASE SYSTEM/S10VE and other package software.
CPMS	An abbreviation for <u>C</u> ompact <u>P</u> rocess <u>M</u> onitor <u>S</u> ystem. CPMS is the operating system that runs on the processor unit.
RPDP	An abbreviation for <u>R</u> ealtime <u>P</u> rogram <u>D</u> eveloping <u>P</u> ackage for S10VE. RPDP is a cross-development environment for programs that run on the S10VE.
MP	An abbreviation for <u>M</u> ain <u>P</u> rocessor.
CP	An abbreviation for <u>C</u> ommunication <u>P</u> rocessor. This processor runs communication programs that regularly use I/O interfaces and memory interfaces for I/O and network access.
HP	An abbreviation for <u>H</u> igh-speed <u>P</u> rocessor. This processor controls the execution of ladder programs and HI-FLOW programs. It runs programs regularly and performs PI/O input and output.
SPU	An abbreviation for <u>S</u> equences <u>P</u> rocessing <u>U</u> nit. The SPU is an arithmetic processing unit for ladder programs.
Backup	A function that saves programs and data.
Restore	A function that sends programs and data.
NAND flash memory	<u>N</u> ot <u>A</u> ND flash memory. NAND flash memory is non-volatile memory used as a backup for main memory. If the data in main memory is lost, the system can recover by copying the data from NAND flash memory back to main memory.
MRAM	An abbreviation for <u>M</u> agneto-resistive <u>R</u> andom <u>A</u> ccess <u>M</u> emory. MRAM is non-volatile memory that stores management information for software such as firmware or CPMS.
Tool, software product	A term that describes packaged software such as BASE SYSTEM/S10VE.

Contents

1. Usage Notes	1-1
2. Overview	2-1
2.1 Overview of the system	2-1
2.2 System configuration	2-1
2.2.1 Example system configuration	2-1
2.2.2 CPU unit configuration	2-2
2.2.3 Configuration of remote I/O communication	2-3
2.3 System components	2-5
2.3.1 Components of CPU unit	2-5
2.3.2 PI/O units and peripherals	2-7
2.3.3 PADT	2-7
3. Specifications	3-1
4. Using the S10VE System	4-1
5. Part Names and Functions	5-1
5.1 Mount base (HSC-1770)	5-1
5.2 Power supply module (LQV410)	5-3
5.3 CPU module (LQP600)	5-5
5.4 RI/O-IF module (LQE950)	5-9
6. Installation	6-1
6.1 Operating environment	6-1
6.2 Grounding	6-1
6.3 Grounding the cabinets	6-2
6.4 Mounting clearances	6-4
6.5 External dimensions of mount base	6-5
6.6 Attaching the mount base	6-6
6.7 Attaching modules	6-7
6.8 Connecting the primary battery	6-9
6.9 Mounting modules	6-10
6.10 Restrictions on mounting option modules	6-11
6.11 Restrictions on mounting PI/O modules to the CPU unit	6-12
6.12 Current consumption calculation table	6-15

7. Wiring	7-1
7.1 Cable specifications	7-1
7.2 Wiring standards	7-3
7.2.1 Terminal block and solderless terminals	7-3
7.2.2 Attaching the terminal block	7-5
7.3 Power supply wiring	7-6
7.4 Ground wiring	7-8
7.5 Wiring the power supply module	7-10
7.6 Wiring for external I/O signals of the RI/O-IF module	7-12
7.6.1 Wiring for PCsOK signal	7-12
7.6.2 Wiring for RI/O STOP and CPU STOP/RUN signals	7-13
7.7 Wiring for remote I/O	7-14
7.7.1 Connecting the remote I/O cables	7-14
7.7.2 Examples of improper remote I/O wiring	7-15
7.7.3 Examples of cable wiring	7-16
7.7.4 Setting terminating resistance	7-18
7.7.5 Connecting the remote I/O cable shields	7-20
7.8 Wiring the Ethernet cabling	7-23
7.9 Circuit classifications and examples of duct wiring	7-23
7.9.1 Circuit classifications for wiring	7-23
7.9.2 Example of duct wiring	7-24
7.10 Working with connector caps	7-25
8. Tools	8-1
8.1 Notes on tool usage	8-1
8.1.1 Overview of tools	8-1
8.1.2 Hardware and software requirements	8-1
8.1.3 Restrictions on connection configuration of PADT and S10VE	8-1
8.2 Constructing the system	8-2
8.2.1 Constructing a new system	8-2
8.2.2 Replacing the CPMS	8-4
8.2.3 Installing the tools	8-5
8.2.3.1 Notes on installation	8-5
8.2.3.2 Installing individual tools	8-6
8.2.3.3 Uninstalling individual tools	8-8
8.2.3.4 Reinstalling individual tools	8-10
8.2.3.5 Installing and uninstalling tools from the basic installation set	8-11

8.3 Starting the system	8-13
8.3.1 Starting tools	8-13
8.3.1.1 Starting BASE SYSTEM	8-13
8.3.1.2 Starting LADDER DIAGRAM SYSTEM	8-15
8.3.1.3 Starting HI-FLOW SYSTEM	8-16
8.3.1.4 Starting the setup tools	8-17
8.3.2 Exiting tools	8-18
8.3.2.1 Exiting BASE SYSTEM	8-18
8.3.2.2 Exiting the LADDER and HI-FLOW systems	8-18
8.3.2.3 Exiting setup tools	8-18
8.4 BASE SYSTEM	8-19
8.4.1 Layout of the BASE SYSTEM main window	8-19
8.4.1.1 Main menu	8-19
8.4.1.2 Status bar	8-20
8.4.2 Project functions	8-21
8.4.2.1 Project menu: New	8-22
8.4.2.2 Project menu: Open	8-27
8.4.2.3 Project menu: Close	8-28
8.4.2.4 Project menu: Delete	8-29
8.4.2.5 Project menu: Set Network	8-31
8.4.2.5.1 Network configuration of CPU built-in Ethernet	8-32
8.4.2.5.2 ET.NET configuration	8-36
8.4.2.6 Project menu: Download CPMS	8-47
8.4.2.7 Project menu: End	8-50
8.4.3 Online functions	8-51
8.4.3.1 Online menu: Change PCs	8-52
8.4.3.2 Online menu: Display PCs STATUS and Change PCs STATUS	8-53
8.4.3.3 Online menu: Data send/receive	8-58
8.4.3.3.1 Sending data	8-59
8.4.3.3.2 Receiving data	8-62
8.4.3.3.3 Comparing data	8-64
8.4.3.3.4 Deleting data	8-67
8.4.3.4 Online menu: Backup, Restore, Backup save data comparison	8-68
8.4.3.5 Online menu: Remote Reset	8-68
8.4.3.6 Online menu: Remote Restart	8-69
8.4.3.7 Online menu: Data Clear	8-70
8.4.4 Program functions	8-72
8.4.4.1 Program menu: LADDER	8-73

8.4.4.2 Program menu: HI-FLOW	8-73
8.4.4.3 Program menu: Setting Tool	8-73
8.4.5 Setting functions	8-75
8.4.5.1 Setting menu: Set Time	8-76
8.4.6 RAS functions	8-77
8.4.6.1 RAS menu: Module List	8-78
8.4.6.2 RAS menu: Error Log Display	8-79
8.4.6.3 Displaying error log details	8-83
8.4.6.4 RAS menu: MCS	8-85
8.4.6.5 RAS menu: Display Performance	8-87
8.4.6.6 RAS menu: Event Register	8-89
8.4.6.7 RAS menu: Network Information	8-90
8.4.6.8 RAS menu: Ethernet Communication of Trace Log	8-92
8.4.6.9 RAS menu: DHP Information	8-95
8.4.6.10 RAS menu: AutoSave	8-97
8.4.7 CPMS debugger functions	8-110
8.4.7.1 CPMS Debugger menu: Task Abort	8-111
8.4.7.2 CPMS Debugger menu: Display Task Status	8-112
8.4.7.3 CPMS Debugger menu: Initialize Task	8-114
8.5 BACKUP RESTORE SYSTEM	8-117
8.5.1 Backup	8-117
8.5.2 Restore	8-126
8.5.3 Backup save data comparison	8-133
8.5.4 Duration of backup/restoration processes	8-139
8.5.5 Scope of backup, restoration, and comparison	8-140
8.6 Other functions	8-143
8.6.1 Operation history recording function	8-143
8.7 Contents of CPMS files	8-147
8.8 Error messages	8-147
8.8.1 Common	8-148
8.8.2 Project menu	8-150
8.8.3 Online menu	8-155
8.8.4 Program menu	8-159
8.8.5 Setting menu	8-159
8.8.6 RAS menu	8-160
8.8.7 CPMS Debugger menu	8-161
8.8.8 RPC error messages	8-163
8.8.9 Error codes	8-164

9. Settings	9-1
9.1 Setting items	9-1
9.2 I/O number structure and scope of allocation	9-4
9.3 Setting PI/O and remote I/O	9-5
9.3.1 PI/O installation setting	9-5
9.3.2 Partition setting (FIX/FREE)	9-6
9.3.3 Output hold setting for digital output modules	9-8
9.3.4 I/O point number setting	9-8
9.3.5 Ladder synchronous/asynchronous mode setting	9-11
9.3.6 Remote I/O optical adapter connection setting	9-12
9.3.7 Remote I/O point setting	9-12
9.4 Analog module and pulse counter module settings	9-13
10. Indicator	10-1
10.1 Overview	10-1
10.2 Information displayed on indicator	10-2
10.3 Indicator display transitions	10-3
10.4 Explanation of displayed information	10-5
10.4.1 Home position display	10-5
10.4.2 Firmware version display	10-7
10.4.3 OS version display	10-7
10.4.4 CPU module error status display	10-8
10.4.5 Indicator pattern display (available when CPU module is in STOP mode)	10-10
10.4.6 Ladder mode display (extended menu)	10-11
10.4.7 PCs number display (extended menu)	10-12
10.4.8 Display of E coils in ON mode (extended menu)	10-12
11. Operation	11-1
11.1 Starting and stopping the CPU module	11-1
11.2 User program operations	11-2
11.3 Remote I/O operation	11-4
11.3.1 Remote I/O connection configuration	11-4
11.3.2 Synchronous and asynchronous ladder operation	11-5
11.3.3 Processing time	11-6
11.3.4 Remote I/O transfer points and transfer areas	11-8
11.3.5 Output operations of the digital output module	11-9
11.4 List of states and state transitions	11-10

11.4.1 List of states	11-10
11.4.2 State transitions	11-11
11.5 Backup functionality	11-12
11.6 Clock functionality	11-13
11.6.1 System register for clock control	11-13
11.6.2 Setting the clock by using ladder programs	11-15
11.6.3 Updating the date	11-16
11.7 State signal timing	11-17
11.7.1 PCsOK signal	11-17
11.7.2 Ladder program RUN/STOP signal	11-18
11.7.3 RI/O STOP input signal	11-19
12. Inspection	12-1
12.1 Limited-life components and replacement cycle	12-1
12.2 Periodic check items	12-2
13. Troubleshooting	13-1
13.1 Troubleshooting via visual confirmation of LEDs and indicators	13-2
13.1.1 Power supply module (model: LQV410)	13-2
13.1.2 CPU module (model: LQP600)	13-3
13.2 Troubleshooting individual modules	13-14
13.2.1 CPU module troubleshooting	13-14
13.2.2 Troubleshooting optional modules	13-20
13.2.2.1 OD.RING module troubleshooting	13-20
13.2.2.2 J.NET module troubleshooting	13-33
13.2.2.3 D.NET module troubleshooting	13-43
13.2.2.4 FL.NET module troubleshooting	13-46
13.2.2.5 ET.NET module troubleshooting	13-50
13.2.3 Remote I/O communication troubleshooting	13-84
13.2.3.1 Troubleshooting procedure	13-84
13.2.3.2 Detailed check items	13-88
13.2.3.3 System register	13-93
13.2.3.4 Relationship between the system configuration and system register	13-95
13.2.4 PI/O module troubleshooting	13-97
13.2.4.1 Analog module troubleshooting	13-97
13.2.4.2 Digital module troubleshooting	13-99
13.3 AutoSave procedure	13-100
13.3.1 If the CPU module is connected to PADT	13-100

13.3.2 If the CPU module is not connected to PADT	13-100
14. Adding and Replacing Modules	14-1
14.1 Power supply module (LQV410)	14-1
14.1.1 Removing the power supply module	14-2
14.1.2 Installing a power supply module	14-3
14.2 CPU module (LQP600)	14-4
14.2.1 Replacing the CPU module	14-4
14.2.1.1 Removing the CPU module	14-5
14.2.1.2 Installing a CPU module	14-5
14.2.2 Replacing the primary battery	14-6
14.2.2.1 Replacing the primary battery	14-8
14.3 RI/O-IF module (LQE950)	14-9
14.3.1 Removing the RI/O-IF module	14-9
14.3.2 Installing a RI/O-IF module	14-9
14.4 OD.RING module (LQE510-E)	14-10
14.4.1 Removing the OD.RING module	14-10
14.4.2 Installing an OD.RING module	14-11
14.4.3 Adding an OD.RING module	14-12
14.5 J.NET module (LQE540-E)	14-13
14.5.1 Removing the J.NET module	14-13
14.5.2 Installing a J.NET module	14-14
14.5.3 Adding a J.NET module	14-15
14.6 D.NET module (LQE770-E)	14-16
14.6.1 Removing the D.NET module	14-16
14.6.2 Installing a D.NET module	14-17
14.6.3 Adding a D.NET module	14-18
14.7 FL.NET module (LQE702-E)	14-19
14.7.1 Removing the FL.NET module	14-19
14.7.2 Installing an FL.NET module	14-20
14.7.3 Adding an FL.NET module	14-21
14.8 ET.NET module (LQE260-E)	14-22
14.8.1 Removing the ET.NET module	14-22
14.8.2 Installing an ET.NET module	14-23
14.8.3 Adding an ET.NET module	14-24
14.9 PI/O module	14-25
14.9.1 Removing a PI/O module	14-25
14.9.2 Installing a PI/O module	14-26
14.9.3 Adding a PI/O module	14-26

14.10 Remote I/O optical adapter module (LQZ410)	14-27
14.10.1 Removing the remote I/O optical adapter module	14-27
14.10.2 Installing a remote I/O optical adapter module	14-28
14.11 Backup and restoration	14-29
14.11.1 Backup procedure	14-29
14.11.2 Restoration procedure	14-29
14.12 Disposal	14-29

Appendixes

A. Hitachi Programmable Controller S10VE Repair Request	A-1
B. List of Error Codes	B-1
C. Replacing Software Products in BASE SET/S10VE	C-1
C.1 Preface	C-1
C.2. Cautionary notes	C-1
C.2.1 Cautionary notes on software product installation	C-1
C.2.2 Cautionary notes on CPMS/S10VE	C-2
C.3 Overview of software product replacement procedure	C-3
C.4 Checking version and revision numbers of installed software products	C-5
C.5 Uninstalling software products	C-6
C.6 Installing software products and checking the installed version and revision numbers	C-8
C.7 Replacing CPMS/S10VE in existing projects	C-10
C.8 Setting the connection-target PCs	C-12
C.9 Checking current version and revision numbers of CPMS/S10VE on actual machines	C-13
C.10 Downloading a new version of CPMS/S10VE to an actual machine	C-14
C.11. Checking version and revision numbers of the new CPMS/S10VE downloaded to the actual machine ..	C-15

List of Figures

Figure 1-1 Installation example	1-1
Figure 1-2 Wiring of output module	1-2
Figure 1-3 Grounding example	1-2
Figure 1-4 Power supply voltage and waveform	1-3
Figure 1-5 Grounding method	1-4
Figure 2-1 Example system configuration	2-1
Figure 2-2 Configuration of CPU unit	2-2
Figure 2-3 Configuration of remote I/O communication	2-3
Figure 5-1 External dimensions of 7-slot mount base	5-1
Figure 5-2 External dimensions of power supply module	5-3
Figure 5-3 External dimensions of CPU module	5-5
Figure 5-4 Names of parts inside switch cover of CPU module	5-5
Figure 5-5 Rear view of the CPU module	5-8
Figure 5-6 External dimensions of RI/O-IF module	5-9
Figure 5-7 Terminal block arrangement of RI/O-IF module	5-10
Figure 6-1 Example of panel grounding	6-1
Figure 6-2 Connecting cabinets to ground (multiple cabinets in a row)	6-2
Figure 6-3 Example of base insulation	6-2
Figure 6-4 Unit mounting clearances	6-4
Figure 6-5 External dimensions of S10VE	6-5
Figure 6-6 Attaching the mount base	6-6
Figure 6-7 Attaching a module	6-7
Figure 6-8 Primary battery connection procedure	6-9
Figure 6-9 External view of mount base	6-10
Figure 7-1 18-point terminal block	7-3
Figure 7-2 11-point terminal block	7-3
Figure 7-3 4-point terminal block	7-4
Figure 7-4 Compatible solderless terminal	7-4
Figure 7-5 Connecting solderless terminals to cables	7-4
Figure 7-6 Power supply wiring (with insulating transformer installed on power distribution panel)	7-6
Figure 7-7 Power supply wiring (with insulating transformer installed on S10VE panel (PCs panel))	7-6
Figure 7-8 Example of internal panel wiring	7-7
Figure 7-9 Example of ground wiring	7-8
Figure 7-10 Wiring of power supply module	7-10
Figure 7-11 Input terminal connection diagram	7-10
Figure 7-12 Power module wiring in high-noise environment	7-11

Figure 7-13 Wiring for PCsOK signal	7-12
Figure 7-14 Wiring of RI/O STOP and CPU STOP/RUN signals	7-13
Figure 7-15 Wiring of remote I/O cables	7-14
Figure 7-16 Wiring example when using cables with different characteristics	7-16
Figure 7-17 Wiring example when using HSC-1000 and HSC-2100 series remote I/O stations in the same system	7-17
Figure 7-18 Example of connections within the same panel	7-20
Figure 7-19 Examples of connections between panels installed in a row	7-21
Figure 7-20 Example of connections between different panels	7-22
Figure 7-21 Example of connections in the same panel and between different panels	7-22
Figure 7-22 Wiring the Ethernet cabling	7-23
Figure 7-23 Example of wiring ducts carrying cables for different circuit classifications (top view)	7-24
Figure 7-24 Positions of connector caps on CPU module during shipping	7-25
Figure 7-25 Positions of connector caps on mount base during shipping	7-25
Figure 8-1 User Account Control message	8-6
Figure 8-2 InstallShield Wizard window	8-6
Figure 8-3 InstallShield Wizard Complete window	8-7
Figure 8-4 "Are you sure you want to uninstall the selected application and all of its components?" message ..	8-8
Figure 8-5 Uninstall Complete message (for uninstallation with tool not running)	8-8
Figure 8-6 Uninstall Complete message (for uninstallation of running tool)	8-9
Figure 8-7 Error message displayed by RPDP internal command	8-9
Figure 8-8 User Account Control message (basic installation set)	8-10
Figure 8-9 Setup window (basic installation set)	8-11
Figure 8-10 Screen displayed when BASE SYSTEM starts	8-13
Figure 8-11 Screen displayed when LADDER DIAGRAM SYSTEM starts	8-15
Figure 8-12 Screen displayed when HI-FLOW SYSTEM starts	8-16
Figure 8-13 Setting Tool window	8-17
Figure 8-14 Layout of the BASE SYSTEM main window	8-19
Figure 8-15 Status bar	8-20
Figure 8-16 Window after clicking the Project menu	8-21
Figure 8-17 Properties window	8-22
Figure 8-18 Save confirmation message	8-22
Figure 8-19 Error message when RPDP is not installed	8-23
Figure 8-20 Error message indicating lack of site creation permission	8-23
Figure 8-21 Overwrite confirmation message	8-24
Figure 8-22 Error message indicating that C-mode usage setting cannot be changed	8-24
Figure 8-23 Message asking whether you want to create a project with an existing PCs number	8-25
Figure 8-24 Error message indicating lack of site deletion permission	8-25
Figure 8-25 Error message indicating lack of site update permission	8-26

Figure 8-26 Project List window (opening a project)	8-27
Figure 8-27 Error message indicating lack of site usage permission	8-28
Figure 8-28 Project List window (deleting a project)	8-29
Figure 8-29 Deletion confirmation message	8-30
Figure 8-30 Set Network window	8-32
Figure 8-31 Message asking for confirmation of Ethernet station number overwrite	8-33
Figure 8-32 Reset confirmation message	8-34
Figure 8-33 Reset successful message	8-34
Figure 8-34 Reset failed message	8-35
Figure 8-35 Set Network (ET.NET) window	8-36
Figure 8-36 Route Information window	8-37
Figure 8-37 Option module parameter setup list window	8-37
Figure 8-38 Overwrite confirmation message	8-38
Figure 8-39 Message confirming removal of duplicate settings	8-38
Figure 8-40 Reset confirmation message	8-39
Figure 8-41 Reset successful message	8-39
Figure 8-42 Reset failed message	8-39
Figure 8-43 Open window (Set Network (ET.NET))	8-40
Figure 8-44 File open window	8-41
Figure 8-45 Wrong file selected message	8-41
Figure 8-46 Option module parameter setup list window (deletion)	8-42
Figure 8-47 Confirm deletion message	8-42
Figure 8-48 Save As dialog box	8-43
Figure 8-49 File save window	8-44
Figure 8-50 Error message when connected to ET.NET module	8-47
Figure 8-51 Download CPMS window	8-47
Figure 8-52 Error message when CPU switch is set to STOP	8-47
Figure 8-53 Progress window (download)	8-48
Figure 8-54 Confirmation of ROM load re-execution message	8-48
Figure 8-55 ROM load failure error message	8-49
Figure 8-56 Reset confirmation message (end)	8-50
Figure 8-57 Error message when user does not have operation log write permission	8-50
Figure 8-58 Window after clicking the Online menu	8-51
Figure 8-59 Change PCs window	8-52
Figure 8-60 Message when PCs connection is successful	8-52
Figure 8-61 PCs Status window	8-53
Figure 8-62 Data Send/Receive (Option Module) window	8-58
Figure 8-63 Open window (Data Send/Receive)	8-59

Figure 8-64 Send Data window	8-59
Figure 8-65 Error message displayed when PCs numbers do not match	8-60
Figure 8-66 Error message displayed when module identification codes do not match	8-60
Figure 8-67 Error message displayed when module numbers do not match	8-60
Figure 8-68 Progress window (sending data)	8-61
Figure 8-69 Save As window (Data Send/Receive)	8-62
Figure 8-70 Receive Data window	8-62
Figure 8-71 Progress window (receiving data)	8-63
Figure 8-72 Compare Data window	8-64
Figure 8-73 Progress window (comparing data)	8-64
Figure 8-74 Message indicating that comparison was successful	8-65
Figure 8-75 Overwrite confirmation message	8-65
Figure 8-76 Message indicating inconsistent data (first format)	8-65
Figure 8-77 Message indicating inconsistent data (second format)	8-65
Figure 8-78 Format of comparison error data file	8-66
Figure 8-79 Data deletion confirmation message	8-67
Figure 8-80 Remote reset confirmation message	8-68
Figure 8-81 Remote restart confirmation message	8-69
Figure 8-82 Restart successful message	8-69
Figure 8-83 Restart failed message	8-69
Figure 8-84 Data clear confirmation message	8-70
Figure 8-85 Error detected message	8-71
Figure 8-86 Window after clicking the Program menu	8-72
Figure 8-87 Setting Tool window	8-73
Figure 8-88 Error message displayed when selected tool cannot be run	8-74
Figure 8-89 Window after clicking the Setting menu	8-75
Figure 8-90 Set Time window	8-76
Figure 8-91 Window after clicking the RAS menu	8-77
Figure 8-92 Module List window	8-78
Figure 8-93 Display Error log CP window	8-79
Figure 8-94 Display Error log HP window	8-79
Figure 8-95 Error Log Detail window	8-83
Figure 8-96 MCS window	8-85
Figure 8-97 Rewrite memory in RUN mode confirmation message	8-85
Figure 8-98 Performance window	8-87
Figure 8-99 Event Register Monitor window	8-89
Figure 8-100 Display Status of Network window	8-90
Figure 8-101 Save As window	8-91

Figure 8-102 Display Ethernet Communication of Trace Log (LADDER) window	8-92
Figure 8-103 Display Ethernet Communication of Trace Log (Socket handler) window	8-93
Figure 8-104 Save As window	8-94
Figure 8-105 DHP Information window	8-95
Figure 8-106 Display DHP trace CP side window	8-96
Figure 8-107 AutoSave window	8-97
Figure 8-108 Error message when CPU is in RUN mode	8-97
Figure 8-109 atdmpbs command error message	8-97
Figure 8-110 Executing window	8-98
Figure 8-111 Processing completed message	8-98
Figure 8-112 Structure of autosave file	8-99
Figure 8-113 Format of fault analysis information file	8-100
Figure 8-114 Window after clicking the CPMS Debugger menu	8-110
Figure 8-115 Task Abort window	8-111
Figure 8-116 Task abort confirmation message	8-111
Figure 8-117 Task Status window	8-112
Figure 8-118 Initialize Task window	8-114
Figure 8-119 Error message when CPMS is not downloaded	8-114
Figure 8-120 Error message displayed when data cannot be read	8-115
Figure 8-121 Progress window (initializing task environment)	8-115
Figure 8-122 CPU stop confirmation message for backup function	8-117
Figure 8-123 Backup window	8-118
Figure 8-124 Browse For Folder dialog box	8-118
Figure 8-125 Overwrite confirmation message	8-119
Figure 8-126 State of backup window (when receiving data)	8-119
Figure 8-127 Backup cancelation confirmation message	8-120
Figure 8-128 CPU RUN confirmation message	8-120
Figure 8-129 State of backup window (when backup is canceled)	8-120
Figure 8-130 STOP recovery guidance message	8-121
Figure 8-131 State of backup window (when comparing data)	8-121
Figure 8-132 Data comparison cancelation confirmation message	8-122
Figure 8-133 State of backup window (when data comparison is canceled)	8-122
Figure 8-134 State of backup window (when no inconsistencies are found)	8-123
Figure 8-135 State of backup window (when inconsistencies are found)	8-123
Figure 8-136 Format of COMPARE_ERROR.txt file	8-124
Figure 8-137 CPU stop confirmation message for data restoration	8-126
Figure 8-138 Restore window	8-127
Figure 8-139 Message asking whether to continue restoration	8-128

Figure 8-140 State of Restore window (when sending data)	8-128
Figure 8-141 State of Restore window (when comparing data)	8-128
Figure 8-142 Confirmation message for PCs number change	8-129
Figure 8-143 Window for changing PCs number of restored PCs	8-129
Figure 8-144 CPU RUN confirmation message	8-130
Figure 8-145 STOP recovery guidance message	8-130
Figure 8-146 State of Restore window (when no inconsistencies are found)	8-131
Figure 8-147 State of Restore window (when inconsistencies are found)	8-131
Figure 8-148 Confirmation message for overwriting comparison error data file	8-132
Figure 8-149 CPU stop confirmation message for backup data comparison	8-133
Figure 8-150 Backup save data comparison window	8-134
Figure 8-151 Message asking whether to continue backup data comparison	8-135
Figure 8-152 State of Backup save data comparison window (during data comparison)	8-135
Figure 8-153 Confirmation message when canceling backup data comparison	8-135
Figure 8-154 State of Backup save data comparison window (when data comparison is canceled)	8-136
Figure 8-155 State of Backup save data comparison window (when no inconsistencies are found)	8-136
Figure 8-156 State of Backup save data comparison window (when outputting comparison error data file)	8-136
Figure 8-157 Confirmation message for overwriting comparison error data file	8-137
Figure 8-158 Areas subject to ROM load operation	8-140
Figure 8-159 Format of operation record file	8-143
Figure 10-1 Indicator and menu keys	10-1
Figure 10-2 Indicator display transitions when CPU module is in STOP mode	10-3
Figure 10-3 Indicator display transitions when CPU module is in RUN mode	10-4
Figure 10-4 Display transitions at home position	10-5
Figure 10-5 Display transitions of CPU module error status	10-8
Figure 10-6 Display transitions of indicator patterns	10-10
Figure 10-7 Display transitions of E coils in ON states	10-12
Figure 11-1 User program operation (ladder and HI-FLOW individual use)	11-2
Figure 11-2 User program operation (ladder and HI-FLOW simultaneous use)	11-2
Figure 11-3 Operation when the sequence cycle is longer than the program processing time	11-3
Figure 11-4 Operation when the sequence cycle is shorter than the program processing	11-3
Figure 11-5 Remote I/O connection configuration	11-4
Figure 11-6 Synchronous and asynchronous ladder operation	11-5
Figure 11-7 Processing time concept	11-6
Figure 11-8 Remote I/O transfer point settings	11-8
Figure 11-9 Output operation of the digital output module	11-9
Figure 11-10 S10VE state transitions	11-11
Figure 11-11 Example ladder program for setting the clock	11-15

Figure 11-12 Output timing of the PCsOK signal (from STOP to RUN)	11-17
Figure 11-13 Output timing of the PCsOK signal (from RUN to STOP)	11-17
Figure 11-14 Timing of the STOP/RUN input signal (from OFF to ON)	11-18
Figure 11-15 Timing of the STOP/RUN input signal (from ON to OFF)	11-18
Figure 11-16 Timing of the RI/O STOP input signal (from OFF to ON)	11-19
Figure 11-17 Timing of the RI/O STOP input signal (from ON to OFF)	11-19
Figure 13-1 Troubleshooting procedure	13-1
Figure 13-2 Error freeze information format	13-23
Figure 13-3 Stack frame format	13-25
Figure 13-4 Trace buffer	13-26
Figure 13-5 Trace control table	13-27
Figure 13-6 Usage example 1	13-28
Figure 13-7 Usage example 2	13-28
Figure 13-8 Trace data	13-29
Figure 13-9 Frame header block	13-29
Figure 13-10 Trace cause	13-31
Figure 13-11 Transmission error status	13-31
Figure 13-12 Reception error status	13-32
Figure 13-13 Error freeze information	13-35
Figure 13-14 Address map of the stack frame	13-36
Figure 13-15 Address of the error accumulation counters	13-40
Figure 13-16 Structure of the trace area	13-41
Figure 13-17 Structure of the trace data area	13-42
Figure 13-18 Troubleshooting procedure	13-50
Figure 13-19 Failed parts in an example system configuration	13-51
Figure 13-20 Troubleshooting procedure for the PI/O unit	13-84
Figure 13-21 Troubleshooting procedure for the remote I/O line	13-85
Figure 13-22 Troubleshooting procedure for intermittent timeouts	13-86
Figure 13-23 Example station module connection configuration	13-89
Figure 13-24 Remote I/O optical adapter failure locations	13-90
Figure 13-25 Example station module connection configuration	13-91
Figure 13-26 Example remote I/O optical adapter failure location	13-92
Figure 13-27 Example system configuration	13-95
Figure 14-1 Parts of power supply module involved in replacement process	14-2
Figure 14-2 Parts involved in CPU module replacement process	14-4
Figure 14-3 Diagram of primary battery replacement	14-8
Figure 14-4 Parts involved in RI/O-IF module replacement process	14-9
Figure 14-5 Parts involved in replacement or addition of OD.RING module	14-11

Figure 14-6 Parts involved in replacement or addition of J.NET module 14-14
Figure 14-7 Parts involved in replacement or addition of D.NET module 14-17
Figure 14-8 Parts involved in replacement or addition of FL.NET module 14-20
Figure 14-9 Parts involved in replacement or addition of ET.NET module 14-23

List of Tables

Table 2-1 List of CPU unit components	2-5
Table 3-1 General specifications	3-1
Table 3-2 Mount base specifications	3-2
Table 3-3 Power supply module specifications	3-2
Table 3-4 CPU module specifications	3-3
Table 3-5 RI/O-IF module specifications	3-6
Table 3-6 Primary battery specification	3-7
Table 5-1 Names and functions of 7-slot mount base parts	5-2
Table 5-2 Names and functions of power supply module parts	5-3
Table 5-3 Names and functions of CPU module parts	5-6
Table 5-4 CPU RUN/STOP switch and LADDER RUN/STOP switch	5-6
Table 5-5 Combination settings of the ET ST.No. (Ethernet station number setting) switch	5-7
Table 5-6 LED specifications	5-7
Table 5-7 Names and functions of RI/O-IF module parts	5-9
Table 5-8 Terminal signal names and functions	5-10
Table 6-1 Restrictions on number of option modules	6-11
Table 6-2 Restrictions on number of PI/O modules	6-14
Table 6-3 Current consumption calculation table	6-15
Table 7-1 Cable specifications	7-2
Table 7-2 Recommended cables	7-2
Table 7-3 List of ground wiring requirements	7-9
Table 7-4 Correct and incorrect remote I/O wiring	7-15
Table 7-5 Setting terminating resistance	7-18
Table 7-6 Circuit classifications	7-23
Table 8-1 Types of tool	8-1
Table 8-2 List of Project menu items	8-21
Table 8-3 List of Online menu items	8-51
Table 8-4 Data clear area	8-70
Table 8-5 List of Program menu items	8-72
Table 8-6 Items displayed in Setting Tool window	8-74
Table 8-7 List of Setting menu items	8-75
Table 8-8 List of RAS menu items	8-77
Table 8-9 Items in Module List window	8-78
Table 8-10 Module names that can be selected in Display Error log CP window	8-80
Table 8-11 Items displayed in Display Error log CP and HP windows	8-80
Table 8-12 Items in Selection of the network drop-down list	8-90

Table 8-13 Tabbed pages in Display Status of Network window	8-91
Table 8-14 Information in Ethernet communication trace log (LADDER)	8-92
Table 8-15 Information in Ethernet communication trace log (socket handler)	8-93
Table 8-16 List of CPMS Debugger menu items	8-110
Table 8-17 Information in Task Registration area	8-112
Table 8-18 Task statuses	8-113
Table 8-19 Measured backup/restoration times	8-139
Table 8-20 Scope of backup	8-140
Table 8-21 Scope of restoration	8-142
Table 8-22 Area excluded from backup data comparison	8-142
Table 8-23 Items in operation record file	8-144
Table 8-24 List of CPMS file contents	8-147
Table 8-25 Common error messages	8-148
Table 8-26 Project - New	8-150
Table 8-27 Properties window	8-150
Table 8-28 Project List window (Open)	8-151
Table 8-29 Project List window (Delete)	8-152
Table 8-30 Close	8-152
Table 8-31 Set Network window	8-152
Table 8-32 Download CPMS window	8-153
Table 8-33 End	8-154
Table 8-34 Change PCs window	8-155
Table 8-35 Display PCs STATUS and Change PCs STATUS	8-156
Table 8-36 Data Send/Receive window	8-156
Table 8-37 Backup, Restore, and Backup save data comparison	8-157
Table 8-38 Data Clear	8-158
Table 8-39 Program menu	8-159
Table 8-40 Setting Tool window	8-159
Table 8-41 Set Time window	8-159
Table 8-42 Error log	8-160
Table 8-43 Performance window	8-160
Table 8-44 DHP Information window	8-160
Table 8-45 Task Abort window	8-161
Table 8-46 Initialize Task window	8-162
Table 8-47 RPC error messages	8-163
Table 8-48 xr_rrw_rpl_p, xr_rrw_rrb_p, xr_rrw_stop, and xr_rrw_grstart	8-164
Table 8-49 svaddsite	8-165
Table 8-50 svupdatesiteos.....	8-165

Table 8-51 svstidel	8-165
Table 9-1 Hardware settings	9-1
Table 9-2 Software settings	9-2
Table 9-3 FIX and FREE settings	9-7
Table 9-4 CPU unit I/O number allocation and I/O points used (Partition setting: FREE, First I/O number: 0000)	9-9
Table 9-5 CPU unit I/O number allocation and I/O points used (Partition setting: FIX, First I/O number: 0000)	9-10
Table 10-1 Names and functions of indicator and menu keys	10-1
Table 10-2 Information displayed on indicator	10-2
Table 10-3 CPU module status display	10-5
Table 10-4 Minor error status display	10-6
Table 10-5 Option module error display	10-6
Table 10-6 Serious error code display	10-6
Table 10-7 CPU module error status display	10-9
Table 10-8 Indicator patterns	10-11
Table 10-9 Ladder mode display	10-11
Table 11-1 User programs and remote I/O communications according to the settings of the CPU module	11-1
Table 11-2 Overview of the transmission time required for one cycle (one scan)	11-6
Table 11-3 S10VE state list	11-10
Table 12-1 Limited-life components and replacement cycle	12-1
Table 12-2 Check items	12-2
Table 13-1 Diagnosing problems by visually confirming the power supply module LEDs	13-2
Table 13-2 Diagnosing problems by visually confirming the CPU module LEDs	13-3
Table 13-3 CPU module troubleshooting	13-4
Table 13-4 OD.RING module troubleshooting	13-6
Table 13-5 FL.NET module troubleshooting	13-7
Table 13-6 J.NET module troubleshooting	13-10
Table 13-7 D.NET module troubleshooting	13-11
Table 13-8 ET.NET module troubleshooting	13-12
Table 13-9 Troubleshooting transient hardware failures	13-14
Table 13-10 User program troubleshooting	13-17
Table 13-11 Troubleshooting from the transmission LED (TX) and the reception LED (RX)	13-20
Table 13-12 Troubleshooting from sent and received data	13-21
Table 13-13 Error codes	13-24
Table 13-14 Trace events and processing	13-30
Table 13-15 Error status details	13-32
Table 13-16 Troubleshooting from the transmission LED (TX) and the reception LED (RX)	13-33
Table 13-17 Troubleshooting from sent and received data	13-34
Table 13-18 J.NET module troubleshooting	13-37

Table 13-19 Error codes for communication errors	13-38
Table 13-20 Error codes for errors detected by a station	13-39
Table 13-21 Polling error codes	13-39
Table 13-22 Troubleshooting from the LED status	13-43
Table 13-23 Causes of D.NET module communication failures	13-44
Table 13-24 D.NET module troubleshooting	13-45
Table 13-25 FL.NET module troubleshooting	13-46
Table 13-26 Network failures and corrective actions (when communication is unstable)	13-47
Table 13-27 Assumed failure causes and corrective action, from the LED status of the ET.NET module	13-52
Table 13-28 Error codes reported to the CPU module from the ET.NET module	13-56
Table 13-29 Internal ET.NET module error codes	13-60
Table 13-30 Ethernet communication trace log information (for ladder)	13-63
Table 13-31 Ethernet communication trace log information (for socket handler)	13-64
Table 13-32 DHP trace information	13-65
Table 13-33 Count information	13-76
Table 13-34 Check items for when a failure occurs repeatedly	13-88
Table 13-35 Analyzing failures from the station module LEDs	13-89
Table 13-36 Analyzing failures from remote I/O optical adapter LEDs	13-90
Table 13-37 Check items for when a failure occurs intermittently	13-91
Table 13-38 Failure analysis when a failure occurs intermittently 1	13-91
Table 13-39 Failure analysis when a failure occurs intermittently 2	13-92
Table 13-40 Register used to check the remote I/O line status	13-93
Table 13-41 System register details	13-94
Table 13-42 System register	13-96
Table 13-43 Analog input module troubleshooting	13-97
Table 13-44 Analog output module troubleshooting	13-98
Table 13-45 Digital input module troubleshooting	13-99
Table B-1 List of CPU module error codes	B-1
Table B-2 List of OD.RING module error codes	B-4
Table B-3 List of J.NET module error codes	B-5
Table B-4 List of D.NET module error codes	B-7
Table B-5 List of FL.NET module error codes	B-8
Table B-6 List of ET.NET module error codes	B-10

This page is intentionally left blank.

1. Usage Notes

■ Installation

The programmable controller employs electronic circuit and processor technologies. Note the following in particular:

- When constructing a system, make sure that conditions including the maximum rating, operating power supply voltage range, heat dissipation characteristics, and installation conditions are within the guaranteed operating range described in this manual. Hitachi bears no responsibility for failures or accidents that arise from use of the product outside the guaranteed range.

Even when using the product within the guaranteed range, you must consider the predicted failure rate and failure mode of the product. You can then implement system measures such as making the system failsafe so that operation of the Hitachi product will not cause personal injury, fire, and other consequential damage.

- The Programmable Controllers (PCs[#]) in which the CPU unit and PI/O units are installed are neither fireproof, dustproof, nor waterproof. Install the PCs in steel cabinets that are fireproof, dustproof, and waterproof (see Figure 1-1).

#: PCs means the programmable controllers in their entirety including the CPU unit and PI/O units.

- Use the S10VE in an environment that is within the specifications explained in Chapter 3. To ensure long-term stable operation, we recommend that you use the product at room temperature and normal relative humidity (15 to 35°C and 45 to 85% RH). Using the product in a high-temperature or high-humidity environment or an environment where the temperature varies widely over the course of a day leads to a reduced service life.

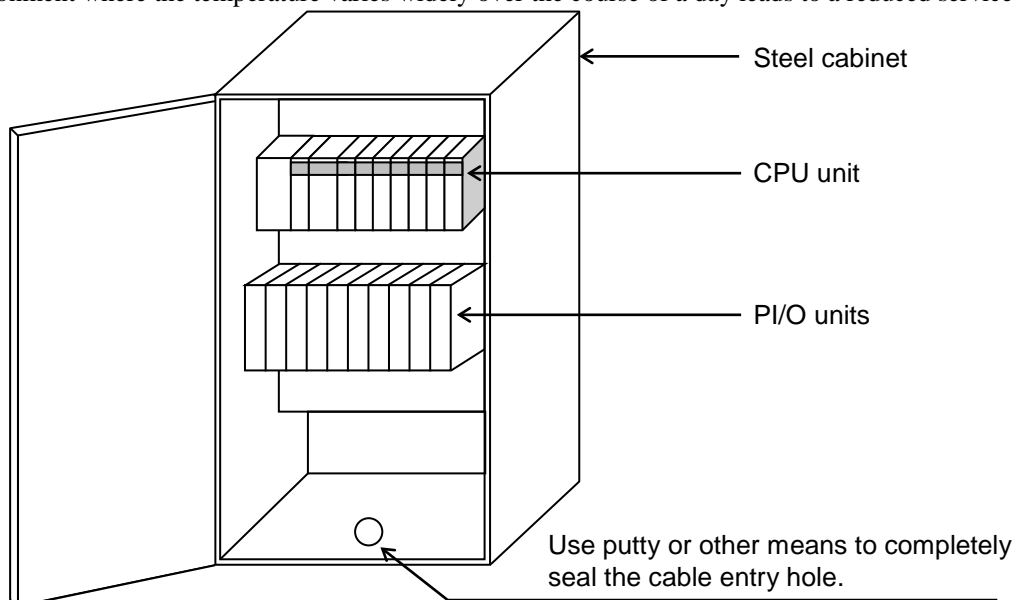

Figure 1-1 Installation example



WARNING

- The S10VE is an open-type device. To avoid electric shock, make sure to install it in an enclosure.

Notice

- There is a potential for failure if PCs are not installed in a waterproof cabinet.
- Static electricity might damage a module or cause it to malfunction. Discharge any static electricity from your body before touching the equipment.
- The system is not designed to withstand constant vibration or shock. If the system is installed in a location subject to such conditions, isolate the system from sources of vibration or shock, or take anti-vibration measures such as the use of anti-vibration rubber mounts.

1. Usage Notes

■ Output module

You must provide a short-circuit protection fuse in the load power supply circuit of the output module. Use fuses with the correct load rating. Using the wrong fuse might result in damage to the PCB or housing if the load short-circuits.

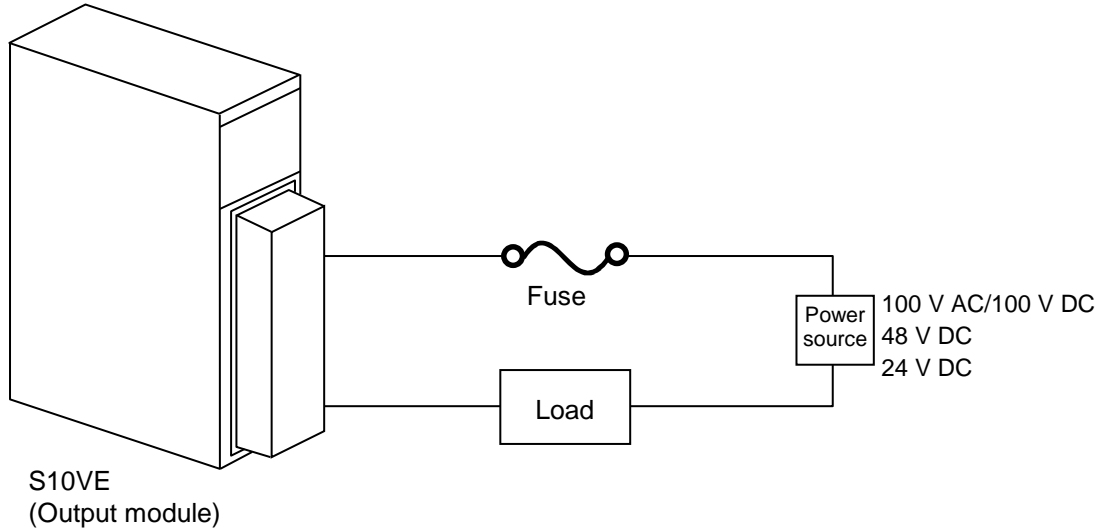

Figure 1-2 Wiring of output module

■ Grounding

● Panel grounding specifications

The PCs panel that incorporates the S10VE must be welded to the steel frame of a building that provides at least class D grounding with the ground resistance of 100Ω or less.

Conditions for grounding to the steel frame of a building

- The steel frame is welded together
- The grounding between the earth and the steel frame meets the criteria for class D

If this is not achievable, ground the PCs panel by connecting it to a grounding rod driven into the earth. This provides a low grounding resistance that prevents surrounding noise from entering the PCs.

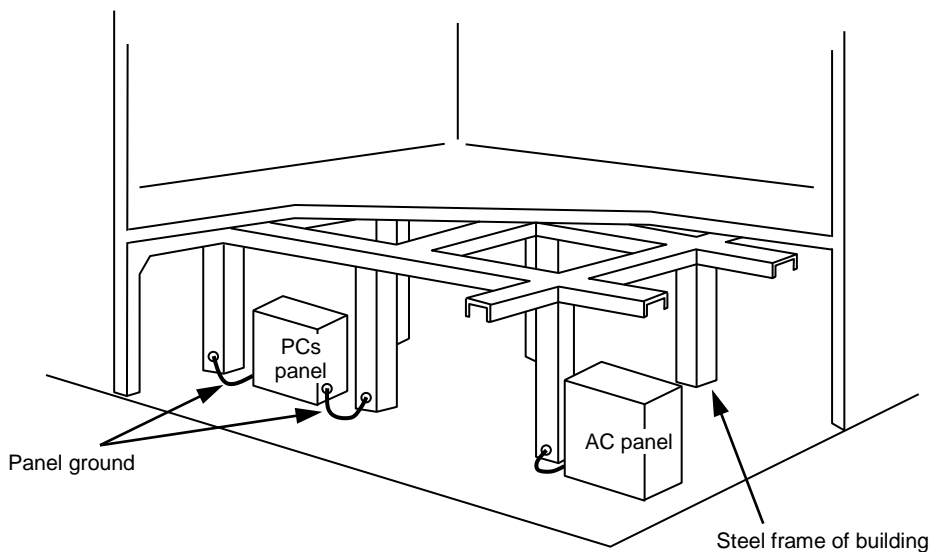

Figure 1-3 Grounding example

■ Noise

Do not install the S10VE in or near a panel to which a high-voltage device (such as an inverter) is mounted. If this is unavoidable, use a shielding plate to shield the CPU unit, PI/O units, and cabling from electromagnetic and electrostatic induction.

■ Emergency stop circuit

A partial failure can affect the entire system. Provide an emergency stop circuit as an external circuit. Do not incorporate the emergency stop circuit into programs run on the programmable controller.

■ Disassembling modules

Do not disassemble the modules.

■ Removing/inserting modules

You must turn off the power before removing or inserting a module. To prevent module damage due to static electricity, discharge any static electricity from your body before touching the equipment.

■ Installation of new equipment

When peripheral equipment is added or replaced, check the following aspects of the power supply and grounding:

● Power supply

Inspect the power supply voltage and waveform.

- Has the voltage dropped?
- Is there any noise in the power cable?

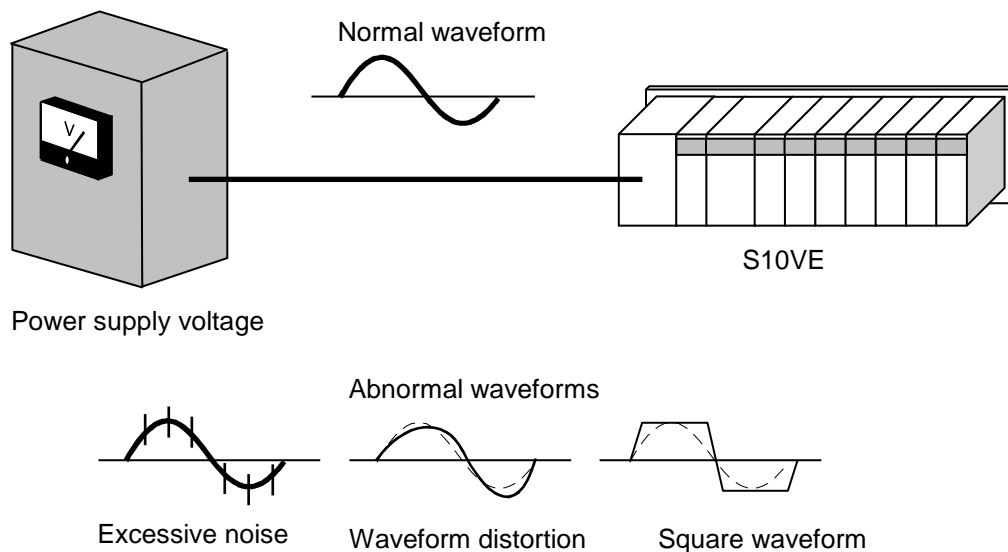

Figure 1-4 Power supply voltage and waveform

1. Usage Notes

- Grounding

- Make sure that the S10VE does not share its ground cable with other equipment.
- Make sure that no power or lead cables are positioned too closely to a signal cable (such as a remote I/O cable).

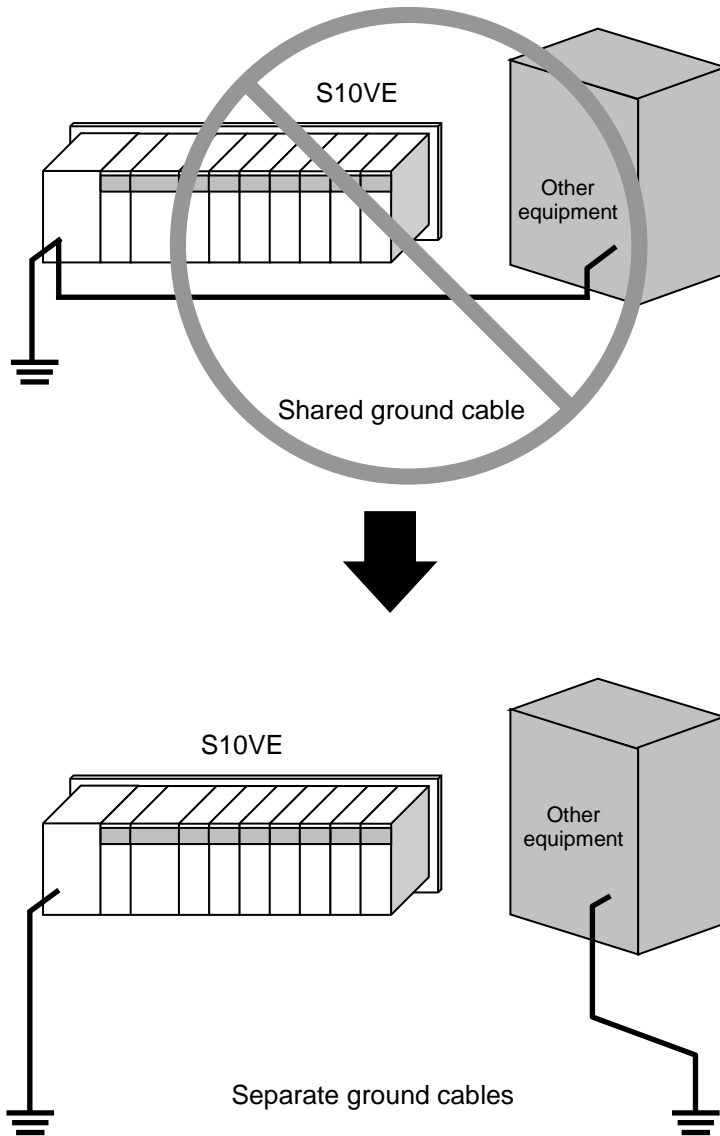

Figure 1-5 Grounding method

 **WARNING**

- To prevent an accident or equipment damage, you must configure an emergency stop circuit external to this product.
- Overcurrent or overvoltage might damage components, resulting in an accident, fire, or damage to equipment. Do not exceed the rated maximum input or output current or input voltage values of the PI/O modules.
- Removing or installing modules with the power supply module turned on might cause electric shock or accident. Turn off the power supply module before performing these tasks.
- Check the wiring carefully before turning on the system. Improper wiring can result in electric shock or fire.
- Incorrect use of the system can lead to accidents and equipment damage. Check the safety of peripheral equipment before modifying a running program or performing RUN or STOP operations.

 **CAUTION**

- Do not insert a finger or foreign object into the gap between a connector and the mount base. Doing so might lead to injury or cause the system to malfunction.
- To avoid fire, use an external power supply with an overvoltage and overcurrent protection function.
- To avoid fire, if you see smoke or smell an unusual odor, turn off the power immediately and investigate the source.
- Do not obstruct the ventilation slots at the top and bottom of the modules. Doing so might cause smoke or fire, or lead to module failure or malfunction.
- The modules have open ventilation slots at the top and bottom. To avoid smoke, fire, and module failure or malfunction, take the necessary measures to prevent objects from falling into the slots.

Notice

- The cabinet in which the CPU and PI/O modules of the S10VE are mounted must have ventilation holes in the door and top panel, or have a fan installed in the door. To improve airflow within the cabinet, make sure that there are gaps at the top, bottom, and sides of each mount base. Failing to provide these gaps might lead to module failure or malfunction.
- To avoid failure and malfunction, consider the following measures during installation design to ensure that the intake air temperature at the center of the base of the power supply module and CPU modules does not exceed 55°C:
 - Make sure there is plenty of space between a unit and those above and below it
 - Use a fan to perform forced air cooling
 - Install a waste heat duct
 - Install a cooler for the control panel
- To prevent equipment damage during transport, protect the equipment with cushioning material and transport it as you would a precision instrument.

This page is intentionally left blank.

2. Overview

2.1 Overview of the system

The S10VE is a programmable controller suited for a wide range of applications from simple condition control to complex arithmetic control. It is capable of simultaneously executing ladder logic, HI-FLOW, and C languages.

2.2 System configuration

2.2.1 Example system configuration

Figure 2-1 shows an example configuration of an S10VE system.

An S10VE system is made up of a CPU unit, PI/O units, and peripherals.

By installing option modules (OD.RING, D.NET, J.NET, FL.NET, ET.NET) in the CPU unit, an S10VE system can connect to an optical communication network and various other optional networks.

By installing a remote I/O interface module (hereafter *RI/O-IF module*) in the CPU unit, the system can connect to HSC-1000 and HSC-2100 PI/O units using remote I/O lines. A given system can incorporate both HSC-1000 and HSC-2100 PI/O units.

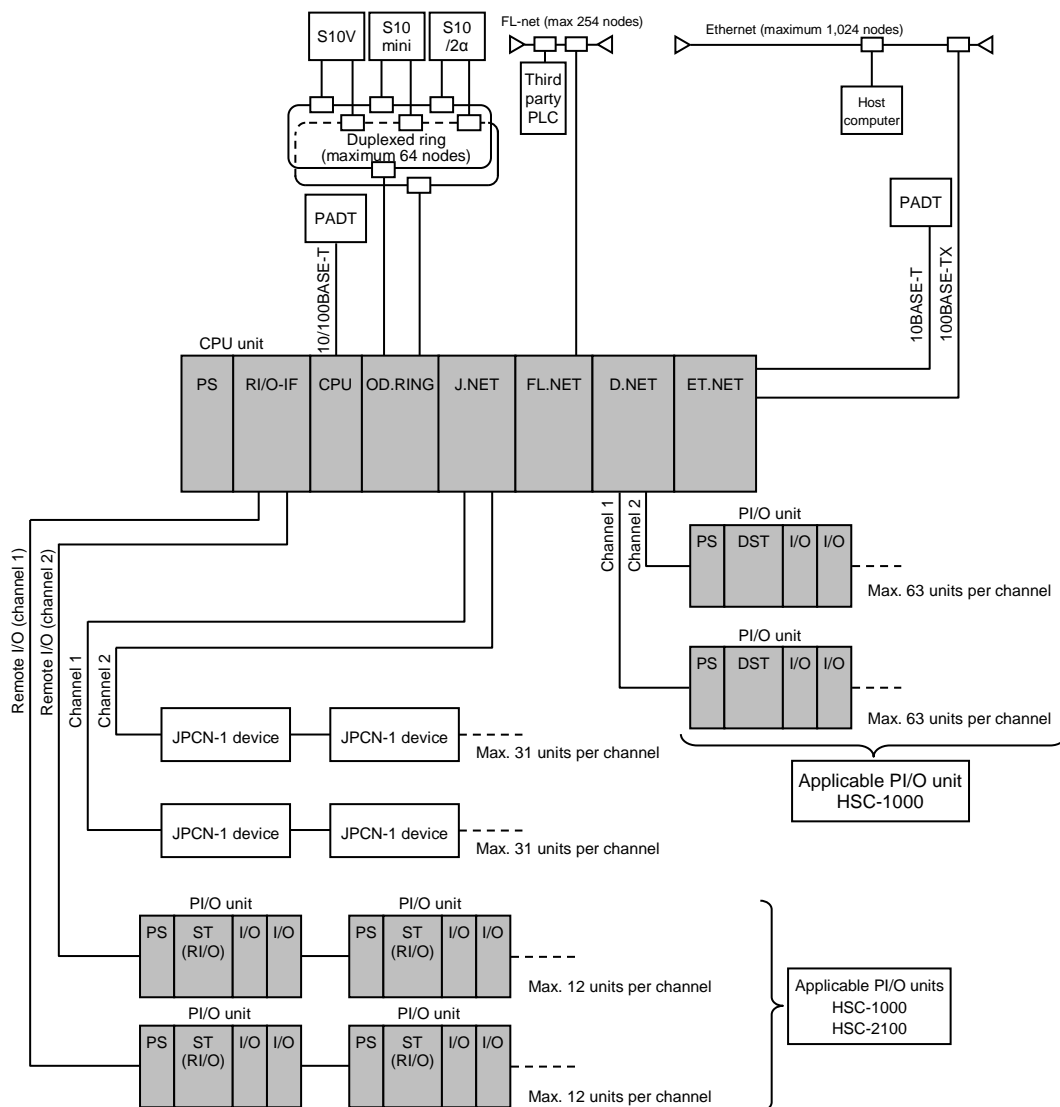

Figure 2-1 Example system configuration

2. Overview

2.2.2 CPU unit configuration

An S10VE system is made up of a mount base, power supply module, RI/O-IF module, CPU module, and PI/O modules. The mount base incorporates one PS slot (a dedicated slot for the power supply module), one IF slot (a dedicated slot for the RI/O-IF module), one CPU slot (a dedicated slot for the CPU module), and seven I/O slots. The power supply module and CPU module are mandatory components of an S10VE system. Installation of an RI/O-IF module, option modules, and PI/O modules is optional.

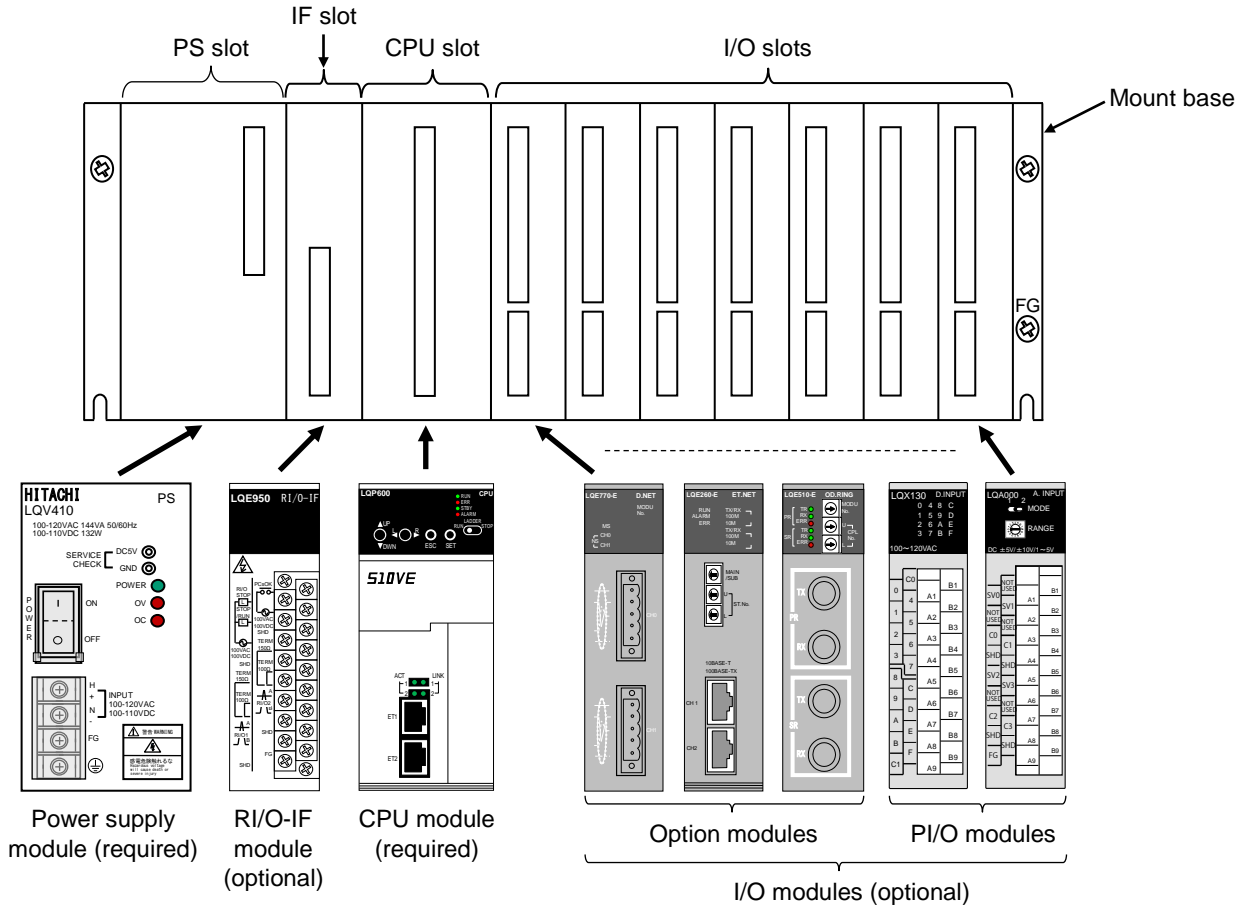

Figure 2-2 Configuration of CPU unit

2.2.3 Configuration of remote I/O communication

The S10VE system can use an RI/O-IF module to perform remote I/O communication on a maximum of two lines (see Figure 2-3).

The maximum length of each line is 300 m by remote I/O cable alone, extendable to a maximum of 3.3 km using remote I/O optical adapters. This length of 3.3 km is three optical cables of 1 km each, plus the 300 m achievable by remote I/O cable.

You can use HSC-1000 and HSC-2100 PI/O units in the same system.

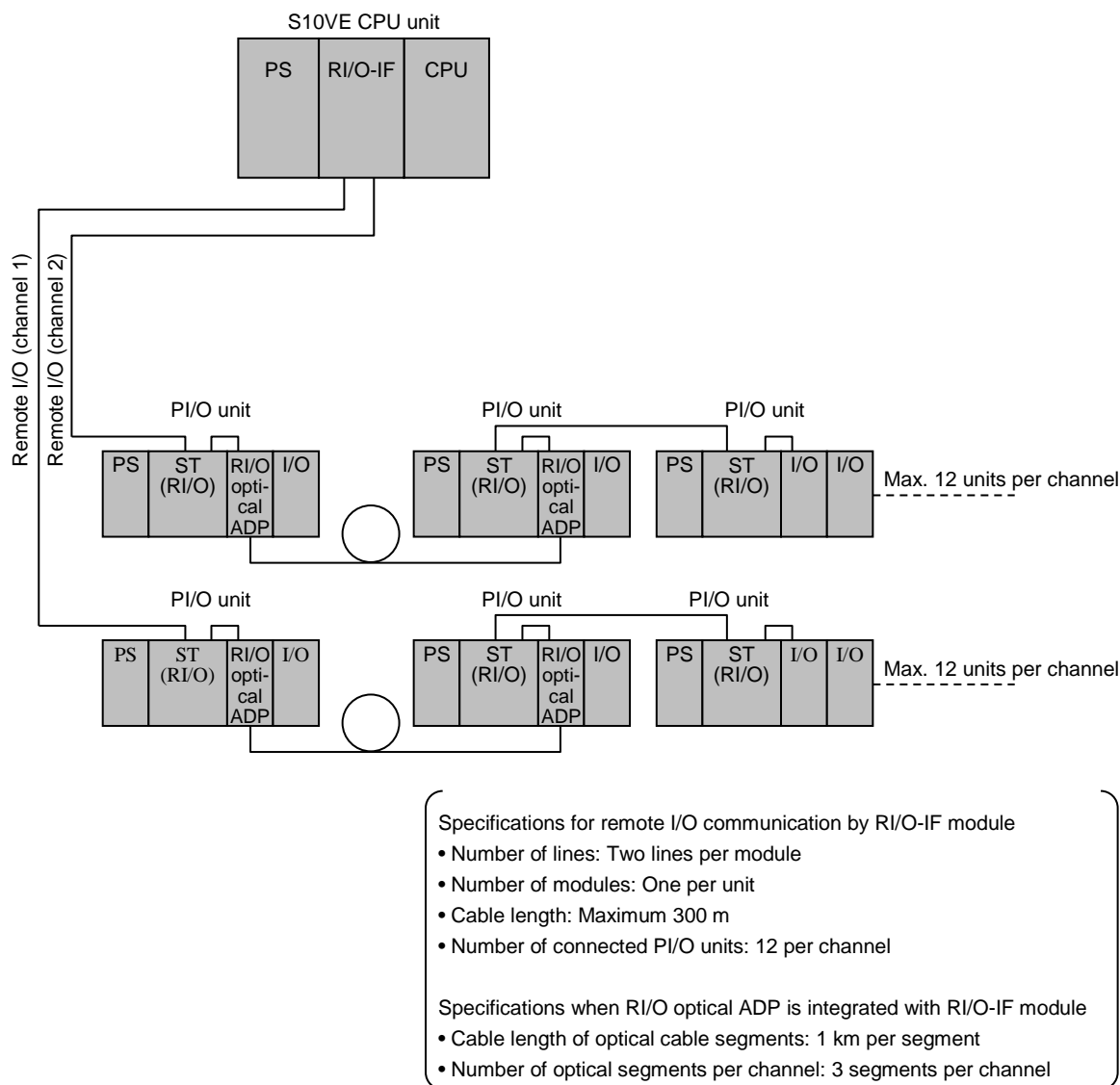

Figure 2-3 Configuration of remote I/O communication

Notice

- In remote I/O communication, there is no way to view error information besides checking the system register and looking at the LED indicators on the station module and remote I/O optical adapter. There is no way to determine from the contents of the received data whether the data was transmitted normally or a time out occurred. This means that in a large-scale or wide area system that has been built using remote I/O optical adapters, it takes a long time to analyze the cause when an issue arises. Because the system register and LED indicators provide current status information, the operator can identify the source of a persistent error, such as that caused by a failed module. However, identifying the source of an error that manifests intermittently such as a partial cable disconnection takes much more time. Given this difficulty in identifying the source of errors related to remote I/O communication, you must keep the following in mind with the objective of streamlining the process of failure analysis when a failure occurs:

A module such as OD.RING makes it easier to analyze faults on a line. Consider using it in your system design where doing so is cost-effective.

- Design the system in a way that considers fault analysis, through such means as centralized installation and PI/O unit aggregation.
 - Prepare an allocation table that shows the correspondence of I/O signals and PI/O addresses with respect to the entire system configuration. This allows you to identify the location of the fault when an issue with data occurs at the application level, such as data not being updated due to a timeout.
 - The CPU module of the S10VE system does not perform external notification if the remote I/O line times out. It is the responsibility of the user to use a program that monitors the system register at the control cycle level and identifies when a timeout occurs.
 - To identify the source of an intermittent fault, it is the responsibility of the user to use a program that saves to memory all areas of the system register related to the remote I/O line when a timeout occurs.
 - Tag each optical cable with its line number to prevent incorrect connection of the remote I/O optical adapter and optical cables.
- If multiple remote I/O optical adapters are installed together, turning off the power supply module of the CPU unit for maintenance of the remote I/O optical adapter prevents any further remote I/O communication that involves the remote I/O optical adapters. When designing the system, consider your maintenance procedures when implementing remote I/O optical adapters.

2.3 System components

2.3.1 Components of CPU unit

Table 2-1 shows the components that make up the CPU unit.

The specifications and functions of the mount base, power supply module, CPU module, and RI/O-IF module are explained in the following chapters:

- Chapter 3: Specifications
- Chapter 5: Part Names and Functions

For details about the specifications and functions of the option modules, see the following manuals:

- S10VE User's Manual Option OD.RING (LQE510-E) (manual number SEE-1-101)
- S10VE User's Manual Option J.NET (LQE540-E) (manual number SEE-1-102)
- S10VE User's Manual Option D.NET (LQE770-E) (manual number SEE-1-103)
- S10VE User's Manual Option FL.NET (LQE702-E) (manual number SEE-1-104)
- S10VE User's Manual Option ET.NET (LQE260-E) (manual number SEE-1-105)

For details about the specifications and functions of the PI/O modules, see the following manual:

- S10mini Hardware Manual I/O Modules (manual number SME-1-114)

Table 2-1 List of CPU unit components (1/2)

No.	Name	Model number	Description
1	Mount base	HSC-1770	- A 7-slot mount base for the S10VE. - A maximum of seven modules (option modules and I/O modules) can be mounted on the mount base. These include the power supply module, CPU module, RI/O-IF module, option modules, and HSC-1000 PI/O modules.
2	Power supply	LQV410	- Input: 100 to 120 V AC, 100 to 110 V DC - Output: 5 V DC, 10 A
3	CPU	LQP600	The CPU module for the S10VE.
4	RI/O-IF	LQE950	The remote I/O interface module.
5	ET.NET	LQE260-E	An option module for the S10VE that provides TCP/IP or UDP/IP protocol communication that conforms to the IEEE802.3i (10BASE-T) or IEEE802.3u (100BASE-TX) specification.
6	OD.RING	LQE510-E	A dedicated option module for the S10VE that allows data sharing through memory transfer between CPU units. For I/O data, the maximum size of shared data is 4,096 points. For word data, the maximum size is 4,096 words.
7	FL.NET	LQE702-E	A dedicated option module for the S10VE that conforms to the FL-net standard. FL-net is an open FA network that was standardized by the JEMA (Japan Electrical Manufacturers' Association). It provides control and monitoring by enabling interconnection of programmable controllers (PLC), personal computers, and other FA devices produced by different manufacturers.

Table 2-1 List of CPU unit components (2/2)

No.	Name	Model number	Description
8	J.NET	LQE540-E	A dedicated option module for the S10VE that complies with the Programmable Controllers - Field Network Standard (level 1) defined by JEMA. This module allows the S10VE to connect to a network that complies with this standard, and perform data communication with all manner of station devices.
9	D.NET	LQE770-E	A dedicated option module for the S10VE that complies with the DeviceNet standard. This module allows the S10VE to perform data communication with various types of DeviceNet-compatible devices connected to the network as a master module, peer module, or slave module, according to its configuration.
10	Remote I/O optical adapter	LQZ410	A module that extends a remote I/O line to a maximum length of 1 km by connecting to an RI/O-IF module and converting optical signals to electrical signals (and vice versa).
11	PI/O	LQX130	Digital input module, 100 V AC contact input, 16 points
12		LQX200	Digital input module, 12 to 24 V DC contact input, 16 points
13		LQX240	Digital input module, 100 V DC contact input, 16 points
14		LQX300	Digital input module, 12 to 24 V DC contact input, 32 points
15		LQX350	Digital input module, 12 to 24 V DC contact input, 64 points
16		LQY100	Digital output module, relay contact output, a contact × 16 points
17		LQY140	Digital output module, relay contact output, a contact × 8 points
18		LQY200	Digital output module, transistor output, 16 points
19		LQY300	Digital output module, transistor output, 32 points
20		LQY350	Digital output module, transistor output, 64 points
21		LQZ300	Digital input/output module Digital input: 12 to 24 V DC contact input, 32 points Digital output: Transistor output, 32 points
22		LQC000	Pulse counter module, pulse input (1-phase, 2-phase), 1 point
23		LQA000	Analog input module, voltage input (DC ±5 V/±10 V/1 to 5 V), 4 points
24		LQA100	Analog input module, current input (DC 4 to 20 mA), 4 points
25		LQA500	Analog output module, voltage output (DC ±5 V/±10 V/1 to 5 V), 4 points

2.3.2 PI/O units and peripherals

A PI/O unit is made up of an HSC-1000 module and an HSC-2100 module. For details, see the following manuals:

- S10mini Hardware Manual I/O Modules (manual number SME-1-114)
- S10mini Hardware Manual D.Station (manual number SME-1-119)
- HSC-2100 Hardware Manual I/O Modules (manual number SME-1-126)

You can also connect a D.NET optical adapter as a peripheral. For details, see the following manual:

- S10mini Hardware Manual OPT.D-NET (manual number SME-1-120)

2.3.3 PADT

PADT (Programming and Debugging Tools) is a programming tool used to make, test, run, and troubleshoot application programs for the S10VE system. The PADT is a personal computer with the required software such as BASE SYSTEM/S10VE installed.

The required specifications for the personal computer that serves as the PADT are as follows:

- 1 GHz or faster CPU
- At least 2GB RAM
- At least 200 MB free hard disk space
- A display resolution of at least 1,366 × 768 (FWXGA)
- Microsoft® Windows® 7 (64bit) operating system or Microsoft® Windows® 10 (64bit) operating system

This page is intentionally left blank.

3. Specifications

Table 3-1 General specifications

	Item	Specification	Remarks
Environmental specifications	Operating temperature	0 to 55°C	Temperature variation of no more than 10°C per hour
	Storage temperature	-20 to 75°C	
	Relative humidity	10 to 90% RH (whether operational or non-operational)	Condensation must be strictly avoided.
	Vibration resistance	Frequency of 10 to 150 Hz, acceleration of 10 m/s ² Sweep time of 8 minutes per cycle in the X, Y, and Z directions Number of sweep cycles: 20	JIS C 60068-2-6 compliant The system must not be installed in a location that is subject to constant vibration [#] .
	Shock resistance	Peak acceleration of 147 m/s ² Half sinusoidal impact wave time of 11 ms, three times each in X, Y, and Z directions	JIS C 60068-2-27 compliant
	Grounding	Class D grounding with the ground resistance of 100Ω or less	
	Ambient air	Dust: 0.1mg/m ³ or less	
	Corrosive gas	JEITA IT-1004A Class B	The environment must be free of corrosive gas.
	Altitude	1,000 m or below	
	Radioactivity	--	The environment must be free of radioactivity.
	Cooling	Natural-air cooling	
Weights	Mount base (HSC-1770)	1,300 g or less	
	Power supply module (LQV410)	1000 g or less	
	CPU module (LQP600)	450 g or less	
	RI/O-IF module (LQE950)	320 g or less	
	OD.RING module (LQE510-E)	410 g or less	
	J.NET module (LQE540-E)	370 g or less	
	FL.NET module (LQE702-E)	275 g or less	
	D.NET module (LQE770-E)	330 g or less	
	ET.NET module (LQE260-E)	380 g or less	
Tightening torque	Mount base mounting screws	1.5 N•m	M5 screws
	Module mounting screws	1.0 N•m	M4 screws
	Mount base FG terminal screws		
	Terminal block mounting screws	0.6 N•m	M3 screws
	Connecting screws		
	Mounting screws for power supply module terminal block cover		

[#]: When installing the system in a location that is subject to constant vibration, implement anti-vibration measures for the control panel.

3. Specifications

Table 3-2 Mount base specifications

Item		Specification	Remarks
Model		HSC-1770	
Slot	PS slot	Power supply module installation slot	
	IF slot	RI/O-IF module installation slot	
	CPU slot	CPU module installation slot	
	I/O slot	Option module or PI/O module installation slot (maximum of 7)	For details about the modules that can be installed and the restrictions that apply, see <i>Chapter 6. Installation</i> .
FG terminal		Yes	
Hot swapping		Not supported	

Table 3-3 Power supply module specifications

Item		Specifications	Remarks
Model		LQV410	
Rated input voltage		100 to 120 V AC	Single phase 50/60 ±5 Hz
		100 to 110 V DC	
Input voltage range		85 to 132 V AC	
		85 to 143 V DC	
Input voltage waveform distortion		AC input	10% or less
		DC input	5% or less
Input current		AC100~120V	1.2A maximum
		DC100~110V	1.2A maximum
Allowable momentary power interruption time		AC85~132V	10ms or less
		DC85~143V	10ms or less
Power consumption		AC100~120V	144VA
		DC100~110V	132W
Rush current		13 A or less ^{#1} (85 to 132 V AC/85 to 143 V DC)	
Rated output current		10 A (5V)	
Dielectric strength withstand voltage		1500 V AC/1 minute	Between all input terminals and all output terminals or between all input terminals and FG/protective grounding terminals.
Hot swapping		Not supported	

#1: Eliminate inrush current of less than 100 microseconds at power-on. Use a circuit breaker that does not shut off in less than 100 microseconds.

Table 3-4 CPU module specifications (1/3)

Item		Specification	Remarks	
Model		LQP600		
Number of I/O points		Maximum 2,048 points		
Programming languages	Ladder diagrams	Supported		
	HI-FLOW	Supported		
	C	Supported		
Instructions	Ladder instructions	77 types		
	Application instructions	141 types		
Memory	Main memory	Size	128 MB	
		Backup	None	
		Error correction	ECC	
	PI/O memory	Use	Data for various programs such as user programs	
		Size	Bit area: 2 MB Word area: 1 MB (including 0.5 MB backup area)	
		Backup	Available (10 years)	
		Error correction	ECC	
	Backup memory	Use	Backup memory for user programs written in C	
		Size	1 MB	
		Backup	Available (10 years)	
		Error correction	ECC	
	Ladder program memory	Backup	Available	
Size		512 k steps		
Processing speed	Bit operations	9.4 ns at peak	Peak performance during pipeline processing	
	Word operations	Addition: 9.4 ns at peak Multiplication: 18.75 ns at peak		
	Floating operations	Addition: 18.75 ns at peak Multiplication: 18.75 ns at peak		

Table 3-4 CPU module specifications (2/3)

	Item	Specifications	Remarks
Ladder function	Internal register (R)	4,096 points	
	Keep relay (K)	4,096 points	
	Timer (T)	2,048 points, ON-delay, time setting (0.1 to 999.9 s)	
	One shot (U)	256 points, one-shot multivibrator time setting (0.1 to 999.9 s)	
	Counter (C)	256 points, up-down counter Time setting (count from 1 to 9,999)	
	Global link register (G)	4,096 points	
	Nesting coil (N)	256 points	Master control or zone control can be selected.
	Process register (P)	128 points	For starting C mode programs
	Event register (E)	65,536 points	0000 to 01FF: For indicator light display 0400 to 23FF: For 4-channel analog pulse counter I/O
	Edge contact (V)	4,096 points	Rising edge or falling edge can be selected.
	System register (S)	49,152 points	Operation result flags, blown fuses, timeouts etc.
	Internal work register (A, J, Q, M)	4,096 points (A, J) 65,536 points (Q, M)	
	Data register (DW)	4,096 points	1 point = 1 word (16 bits)
	Data register (BD)	512 points	1 point = 1 long word (32 bits)
	Work register (FW)	3,072 points	1 point = 1 word (16 bits)
	Data register (LB)	65,536 points	
	Data register (LL)	8,192 points	1 point = 1 long word (32 bits)
	Data register (LF)	8,192 points	1 point = single-precision floating point (32 bits)
	Data register (LW)	65,536 points	1 point = 1 word (16 bits)
	Data register (LM)	8,192 points	1 point = 1 long word (32 bits)
	Data register (LG)	8,192 points	1 point = single-precision floating point (32 bits)
	Data register (LX)	16,384 points	1 point = 1 word (16 bits)
	Data register (LR)	4,096 points	Exclusively used by ladder converter
Edge contact (LV)	4,096 points	Exclusively used by ladder converter	

Table 3-4 CPU module specifications (3/3)

Item	Specification	Remarks	
Tool interface	Ethernet		
Ethernet communication	Number of channels	2 channels (ports are provided on the front of the module)	
	Number of sockets	255 per unit	
	Communication speed	10 Mbps/100 Mbps (auto-negotiation)	
	Dielectric strength withstand voltage	1500 V AC/1 minute	
Clock	Functions	Year, month, day, hour, minute, second, day of week No more than ± 4 seconds per day (ambient temperature 0 to 55°C)	
	Time retained during power outage	Yes (guaranteed for 5 years)	The clock needs to be set again after battery replacement.
Hot swapping	Not supported		
Current consumption	3,100 mA or less		
Startup time	Power ON: 50 seconds or less Reset: 1 second or less (Conditions: CPMS and the application programs are backed up)		

3. Specifications

Table 3-5 R/O-IF module specifications

Item		Specification			Remarks
Model		LQE950			
Remote I/O communication	Line speed	768 kbps			
	Number of lines	2 lines			
	Number of connected units	Maximum of 12 units per line			
	Number of transferred words	Maximum of 64 words (1,024 points) per line			
	Insulation method	Transformer insulation			
	Error detection method	Loop checking with inverted 2-bit data transmission			
	Modulation method	Bipolar modulation			
	Connection mode	Daisy chain			
	Terminating resistance	100Ω or 150Ω			
	Dielectric strength withstand voltage	500 V AC/1 minute			
	Total cable length	Maximum 300 m (Depends on the type of cable used. For details, see <i>Chapter 7. Wiring</i>)			
PCsOK	Output format	Relay output (relay insulation)			
	Rated output	100 V AC, 12 to 24 V DC	48 V DC	100 V DC	
		2 A	0.5 A	0.1 A	
	Minimum output	12 V DC/20 mA			
	Dielectric strength withstand voltage	1500 V AC/1 minute			
	Response time	15 ms or faster			
	Relay service life (electrical)	70,000 times (100 V AC, 2 A (COSφ = 0.4), 24 V DC, 2 A (L/R = 7 ms), Frequency of operation 1,800 times/hour, normal temperature and normal relative humidity)			
Cable specification	Twisted pair cable, 100 m or shorter				
CPU STOP/RUN, R/O STOP	Input format	Contact input (photocoupler insulation)			
	Rated input	100 V AC, 100 V DC/5 mA			
	Input voltage range	85 to 121 V AC, 85 to 110 V DC			
	ON voltage/current	85 V AC or more/3.8 mA or more 85 V DC or more/3.8 mA or more			
	OFF voltage/current	25 V AC or less/1.0 mA or less 25 V DC or less/1.0 mA or less			
	Impedance	20kΩ (approx.)			
	Dielectric strength withstand voltage	1500 V AC/1 minute			
	Response time	15 ms or faster			
Cable specification	Twisted pair cable, 100 m or shorter				
Hot swapping	Not supported				
Current consumption	200 mA or less				

Table 3-6 Primary battery specification

Item	Specification	Remarks
Product type	Lithium manganese oxide battery	
Model	HDC5200	
Output voltage	3 V (approx.)	
Capacity	550 mAh or greater	At delivery
Replacement cycle	Within 5 years	

This page is intentionally left blank.

4. Using the S10VE System

The following lists the procedures related to use of the S10VE system, and where in this manual each procedure is explained.

Procedures:

Overview, Specifications, Warranty
Review the following before using the S10VE system:

- Overview and example configuration of the S10VE system, and its specifications
- Specifications of the PADT PC
- Warranty period, scope, expected service life, repair support period

Reference locations:

⇒ Chapter 1: Usage Notes
Chapter 2: Overview
Chapter 3: Specifications
Warranty and Servicing

Installation
Review the following before installing the S10VE in a control panel:

- Conditions for control panels in which S10VE units are installed
- Installation environment
- How to attach the mount base
- How to attach each type of module
- Connecting the primary battery

⇒ Chapter 5: Part Names and Functions
Chapter 6: Installation

Wiring
Connect the power supply cables to the power supply modules.
Also wire the remote I/O and optional modules.

⇒ Chapter 7: Wiring

Initial setup (hardware)
Configure the switches on each module.

⇒ Chapter 5: Part Names and Functions
Chapter 9: Settings

Initial setup (software)
Perform the following setup:

- Initial setup on PADT side
- Items that require initial setup and the setup procedure (e.g. setting IP addresses, setting the system clock)

⇒ Chapter 8: Tools
Chapter 9: Settings

Creating and loading programs
Create the programs to run on the S10VE system.
Then, load the programs you created onto the S10VE system.

⇒ Chapter 8: Tools
Programming Manual[#]
Operation Manual[#]

Operation
Place the CPU module in RUN status and start operation.

⇒ Chapter 8: Tools
Chapter 10: Indicators
Chapter 11: Operation
Chapter 12: Inspection
Programming Manual[#]
Operation Manual[#]

Periodic checkup
Perform periodic checks of the system.

- Periodic check cycle
- Periodic check items and judgment criteria

⇒ Chapter 12: Inspection
Chapter 14: Adding and Replacing Modules

Service in the event of a failure
When a failure occurs, identify the location where the failure occurred from the information provided by LEDs and other indicators, and replace the affected part.

⇒ Chapter 13: Troubleshooting
Chapter 14: Adding and Replacing Modules

#: Refer to the following manuals:

- S10VE Software Manual Programming Ladder Diagram System for Windows® (manual number SEE-3-121)
- S10VE Software Manual Programming HI-FLOW for Windows® (manual number SEE-3-122)
- S10VE Software Manual Operation Ladder Diagram System for Windows® (manual number SEE-3-131)
- S10VE Software Manual Operation HI-FLOW for Windows® (manual number SEE-3-132)
- S10VE Software Manual Operation NXACP For Windows® (manual number SEE-3-134)
- S10VE Software Manual CPMS General Description and Macro Specifications (manual number SEE-3-201)

This page is intentionally left blank.

5. Part Names and Functions

5.1 Mount base (HSC-1770)

Figure 5-1 shows the external dimensions of the 7-slot mount base. Table 5-1 lists the part names and explains the functions of each part.

(1) External dimensions

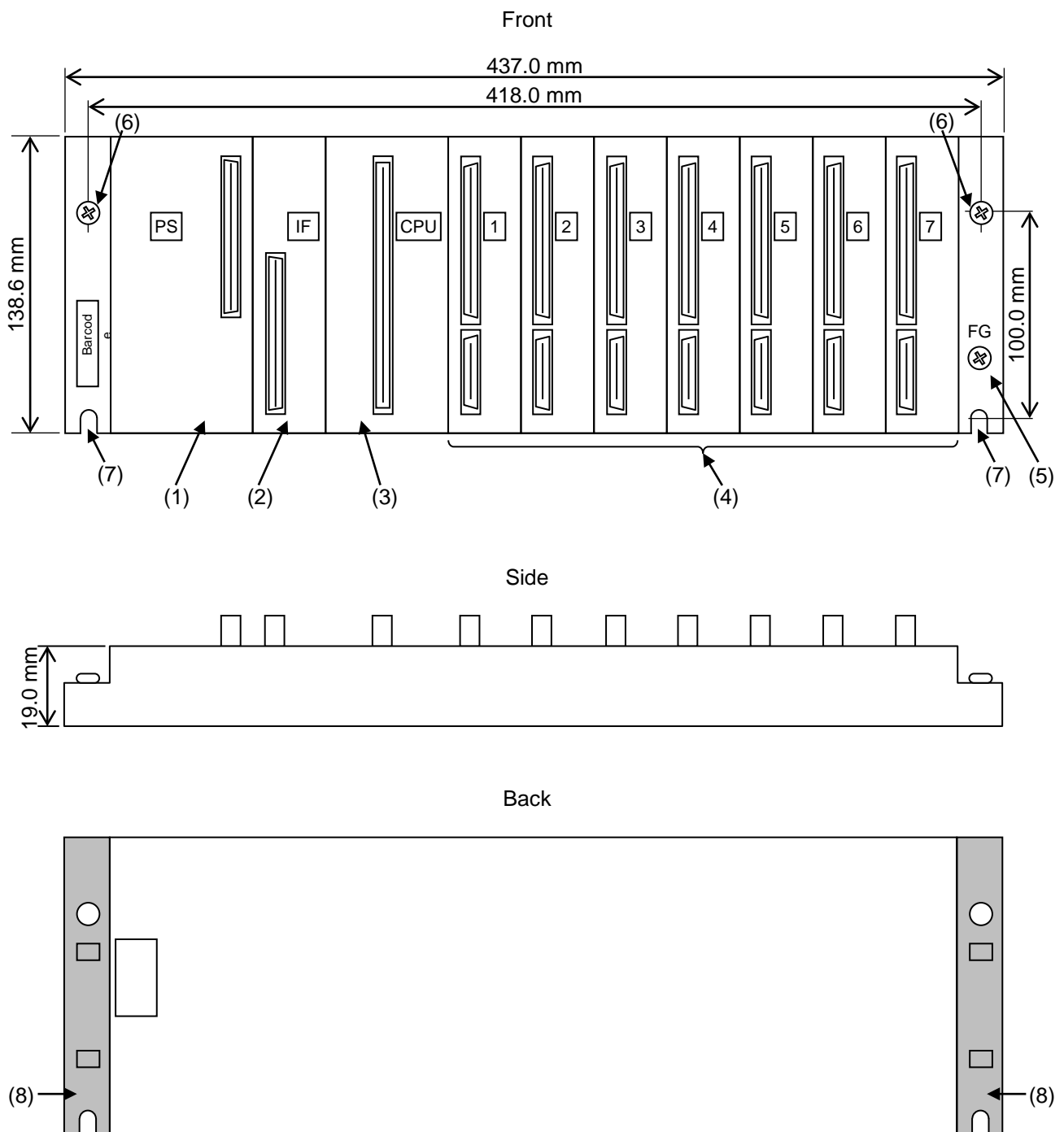

Figure 5-1 External dimensions of 7-slot mount base

5. Part Names and Functions

(2) Part names and functions

Table 5-1 Names and functions of 7-slot mount base parts

No.	Name	Function
(1)	PS (power supply) slot	A slot in which the power supply module is installed.
(2)	IF slot	A slot in which the RI/O-IF module is installed. You do not need to install an RI/O-IF module if the system will not communicate by remote I/O.
(3)	CPU slot	A slot in which the CPU module is installed.
(4)	I/O slot	A slot in which an option module or PI/O module is installed (maximum of 7).
(5)	FG terminal	A terminal used for wiring with the FG terminal of the power supply module (using M4 screws). For details about wiring, see <i>7.4 Ground wiring</i> .
(6)	Mount base fixing screws (×2)	Screws that secure the mount base (M5 screws).
(7)	Mount base fixing screw holes (×2)	Holes into which the screws that secure the mount base are inserted (M5 screws).
(8)	Insulating bush (×2)	Insulates the mount base from the chassis.

5.2 Power supply module (LQV410)

Figure 5-2 shows the external dimensions of the power supply module. Table 5-2 lists the part names and explains the functions of each part.

(1) External dimensions

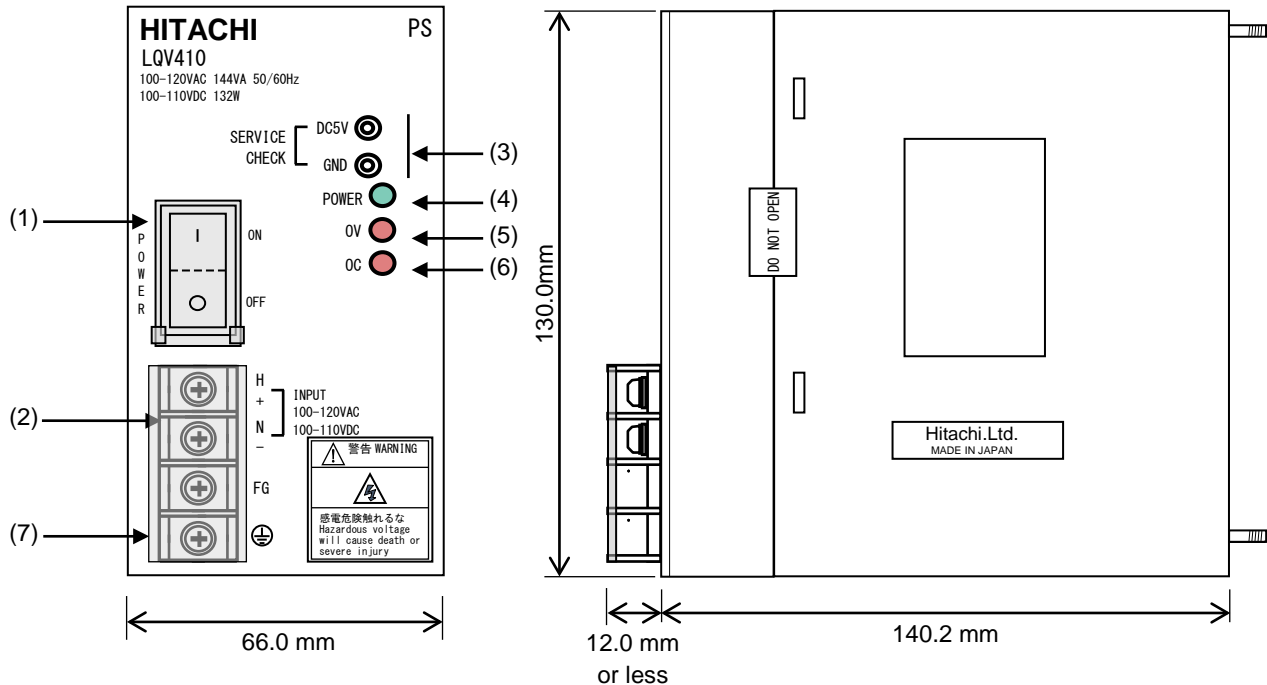

Figure 5-2 External dimensions of power supply module

(2) Part names and functions

Table 5-2 Names and functions of power supply module parts

No.	Name	Function
(1)	Power switch (POWER)	A switch that turns the power on and off.
(2)	Terminal block (INPUT)	Terminals that connect an AC or DC input. For details about how to install the wiring on the terminal block, see <i>Chapter 7. Wiring</i> .
(3)	Output voltage check terminals (DC5V, GND)	Check terminals used to check the output voltage (output error is $\pm 5\%$ or less). Since $1k\Omega$ is connected to the check terminal inside the power supply module, use an instrument with an input impedance of $10 M\Omega$ or more to accurately measure the output voltage.
(4)	POWER LED	Indicates the output status. This LED is lit green during 5 V DC output.
(5)	OV LED	Indicates the overvoltage status. This LED is off when the output voltage is normal, and lights red upon detecting overvoltage on the 5 V DC output.
(6)	OC LED	Indicates the overcurrent status. This LED is off when the output current is normal, and lights red upon detecting overcurrent on the 5 V DC output.
(7)	Terminal block cover	A cover that protects the terminal block.



WARNING

- To avoid electric shock, take the following precautions:
 - Do not touch the power supply terminals while input power is present.
 - Before wiring the power supply, make sure that no voltage is applied to the power cable.
 - Attach the terminal cover as soon as you finish wiring the power supply.
 - To prevent your fingers from touching conductive parts, use solderless terminals with insulating covers.

Notice

- To prevent damage to the power supply module, take the following precautions:
 - Leave sufficient time (at least 5 seconds) between turning the power switch off and on.
 - Do not repeatedly turn the power switch on and off.
 - Input voltage must increase and decrease monotonically between 0 and 85V.
 - Do not supply a fluctuating input voltage that might cause the power supply module to repeatedly start and stop.

5.3 CPU module (LQP600)

Figure 5-3 shows the external dimensions of the CPU module. Table 5-3 lists the part names and explains the functions of each part.

(1) External dimensions

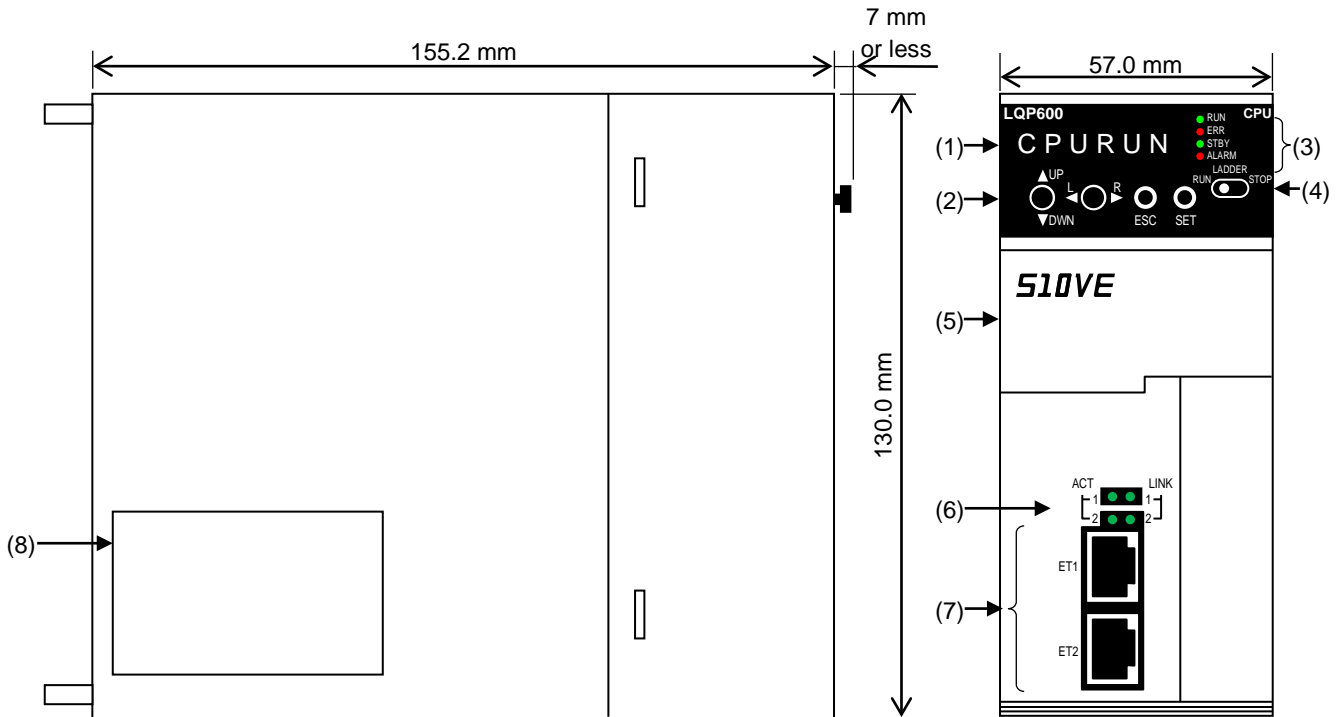

Figure 5-3 External dimensions of CPU module

(2) Names of parts inside switch cover

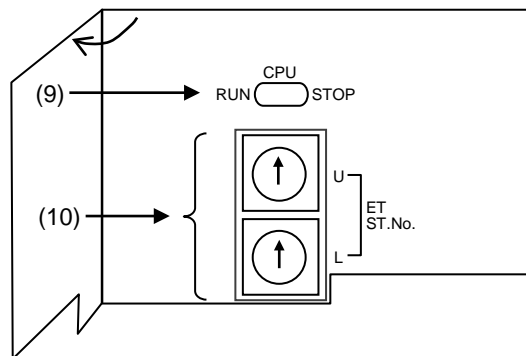

Figure 5-4 Names of parts inside switch cover of CPU module

5. Part Names and Functions

(3) Part names and functions

Table 5-3 Names and functions of CPU module parts

No.	Name	Function
(1)	Indicator	An indicator that shows the operating status of the S10VE system. For details, see Chapter 10.
(2)	Menu keys	Menu keys that allow you to navigate through various settings. For details, see Chapter 10.
(3)	CPU status display LEDs	LEDs that indicate the operating status of the CPU. For details, see Table 5-6.
(4)	LADDER RUN/STOP switch	A switch that issues RUN or STOP instructions for ladder programs. For details, see Table 5-4.
(5)	Switch cover	A cover that protects the CPU RUN/STOP switch and the ET ST.No. switches.
(6)	ACT LED, LINK LED	LEDs that indicate the Ethernet communication status. For details, see Table 5-6.
(7)	ET1 and ET2 connectors	Communication ports (2 ports) that conform to the 10 BASE-T/100 BASE-TX standard.
(8)	Primary battery cover	The cover for the primary battery.
(9)	CPU RUN/STOP switch	A switch that sets the operation mode of the CPU module to RUN or STOP. For details, see Table 5-4.
(10)	ET ST.No.	Switches that set the Ethernet station number. For details, see Table 5-5.

(4) Switch specifications

Table 5-4 CPU RUN/STOP switch and LADDER RUN/STOP switch

Switch operation		Behavior
CPU RUN/STOP switch	LADDER RUN/STOP switch	
STOP → RUN	--	Performs a reset-start.
RUN	STOP	The ladder program is stopped. Tasks and the OS are operating.
RUN	RUN	The ladder program, tasks, and the OS are operating.
RUN	RUN → STOP	Switching from RUN to STOP transitions to a state where the ladder program is stopped and tasks and the OS are operating.
RUN → STOP	--	Stops the CPU module.
STOP	STOP	The CPU module is reset, entering STOP status again after resetting.
STOP	RUN	The CPU module is reset, entering STOP status again after resetting.
STOP	RUN → STOP	No change in status.

Table 5-5 Combination settings of the ET ST.No. (Ethernet station number setting) switch

No.	Setting value		Description
	U	L	
1	F	F	The Ethernet ports operate using the following fixed IP addresses: CH1: 192.192.192.1 CH2: 192.192.193.1
2	Other than the above		The Ethernet ports operate using the IP addresses you have set. For details about how to set IP addresses, see <i>8.4.2.5 Network configuration</i> .

(5) LED specifications

Table 5-6 LED specifications

Name	Color	Specification
RUN	Green	An LED that indicates the operating status of the ladder program. This LED is lit when the ladder program is running.
ALARM	Red	An LED that indicates that an issue of some kind has occurred. This might be a drop in the capacity of the primary battery, an issue with an option module, or a minor failure (including both major and minor failures of option modules).
ERR	Red	An LED that indicates the major failure status of the system. This LED is lit when a major failure has occurred.
STBY	Green	An LED indicating whether the CPU is in a standby state. This LED is lit when the CPU is in a standby state.
LINK1	Green	An LED indicating the status of the physical connection between the ET1 port and its peer. This LED is lit when a physical link is established.
LINK2	Green	An LED indicating the status of the physical connection between the ET2 port and its peer. This LED is lit when a physical link is established.
ACT1	Green	This LED is lit when data is being transferred between the ET1 port and its peer.
ACT2	Green	This LED is lit when data is being transferred between the ET2 port and its peer.

For details about the operating status of the CPU unit that each combination of LEDs represents, see *Chapter 11. Operation*.

5. Part Names and Functions

(6) Rear view

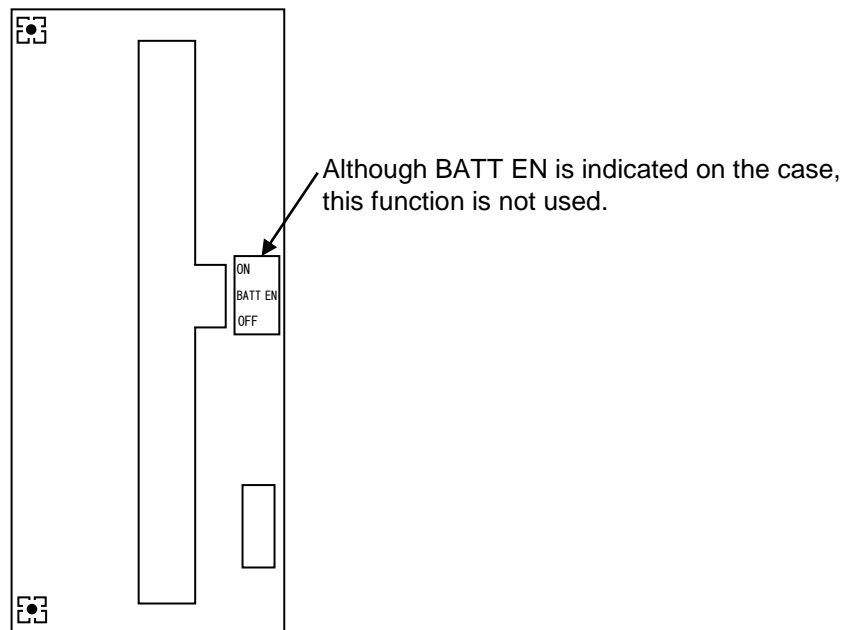

Figure 5-5 Rear view of the CPU module

5.4 RI/O-IF module (LQE950)

Figure 5-6 shows the external dimensions of the RI/O-IF module. Table 5-7 lists the part names and explains the functions of each part.

(1) External dimensions

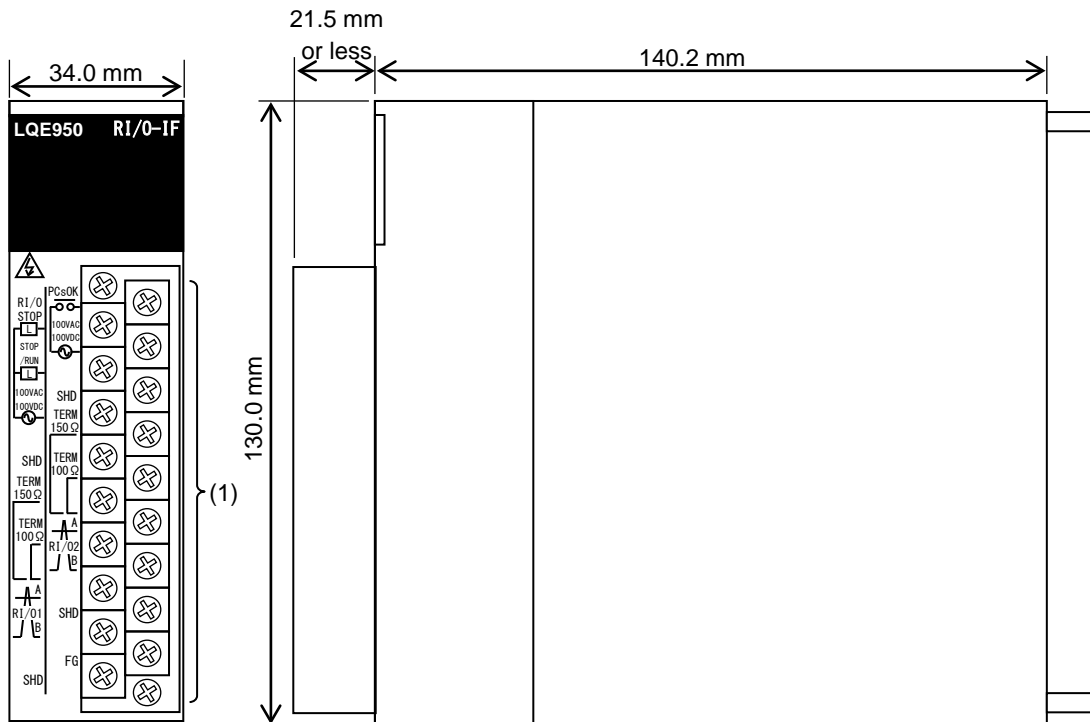

Figure 5-6 External dimensions of RI/O-IF module

(2) Part names and functions

Table 5-7 Names and functions of RI/O-IF module parts

No.	Name	Function
(1)	Terminal block	A terminal block that provides the connections for remote I/O cables. These terminals are used for PCsOK output, STOP/RUN input, and RI/O STOP input.

5. Part Names and Functions

(3) Terminal block layout

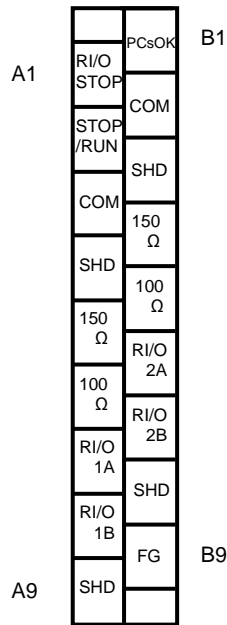

Figure 5-7 Terminal block arrangement of RI/O-IF module

(4) Signal names and their functions

Table 5-8 Terminal signal names and functions

Terminal number	Signal name	Purpose
A1	RI/O STOP	An input terminal for an external control signal to stop remote I/O communication.
A2	STOP/RUN	An input terminal for an external control signal that sets the mode of the ladder program to RUN or STOP.
A3	COM	A common terminal for the RI/O STOP input and STOP/RUN input signals.
A4	SHD	A shield connection terminal for the RI/O STOP input and STOP/RUN input signal cables.
A5	150Ω	A terminal for configuring the terminating resistor (150Ω) on remote I/O line 1.
A6	100Ω	A terminal for configuring the terminating resistor (100Ω) on remote I/O line 1.
A7	RI/O1A	A terminal for connecting a data line of remote I/O line 1.
A8	RI/O1B	
A9	SHD	A shield connection terminal for the remote I/O line 1 cable.
B1	PCsOK	A terminal that outputs a contact point ON signal when the state of the ladder program is RUN.
B2	COM	A common terminal for PCsOK output.
B3	SHD	A shield terminal for the PCsOK output cable.
B4	150Ω	A terminal for configuring the terminating resistor (150Ω) on remote I/O line 2.
B5	100Ω	A terminal for configuring the terminating resistor (100Ω) on remote I/O line 2.
B6	RI/O2A	Terminals for connecting data lines of the remote I/O line 2 cable.
B7	RI/O2B	
B8	SHD	A shield connection terminal for the remote I/O line 2 cable.
B9	FG	A terminal used for wiring with the FG terminal of the power supply module. For details about wiring, see 7.4 Ground wiring.

For details about how to make connections to the terminals of the RI/O-IF module, see *Chapter 7. Wiring*.

6. Installation

6.1 Operating environment

For details about the operating environment of the S10VE system see *Chapter 3. Specifications.*

6.2 Grounding

The PCs panel that incorporates the S10VE must be welded to the steel frame of a building that provides class D grounding with the ground resistance of 100Ω or less. If this is not achievable, ground the panel by connecting it to a grounding rod driven into the earth.

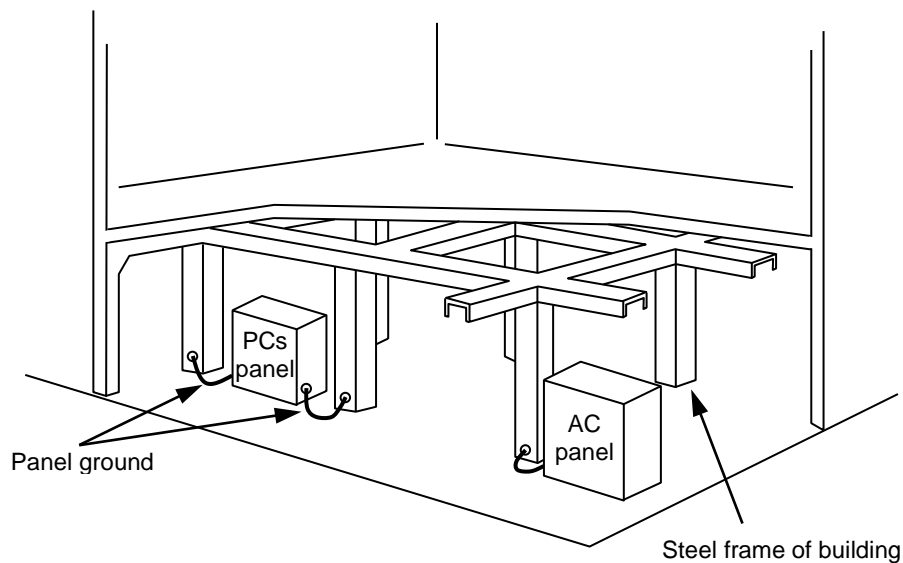

Figure 6-1 Example of panel grounding

Notice

- If the environment does not meet the conditions for grounding to the steel frame of the building, drive a grounding rod in the earth near the PCs panel that provides a low grounding resistance. This prevents surrounding noise from entering the PCs and prevents equipment from failing or malfunctioning.
Conditions for grounding to steel frame of building:
 - The steel frame is welded together.
 - The grounding between the earth and the steel frame meets the criteria for class D.
 - To prevent AC current from entering the grounding point of the PCs panel, the grounding point connects to a different main line from the AC panel, separated by a distance of at least 15 m.

6.3 Grounding the cabinets

When installing multiple cabinets in a row, daisy-chain the grounding cables as shown in Figure 6-2, and connect the last grounding cable to ground via a ground bar.

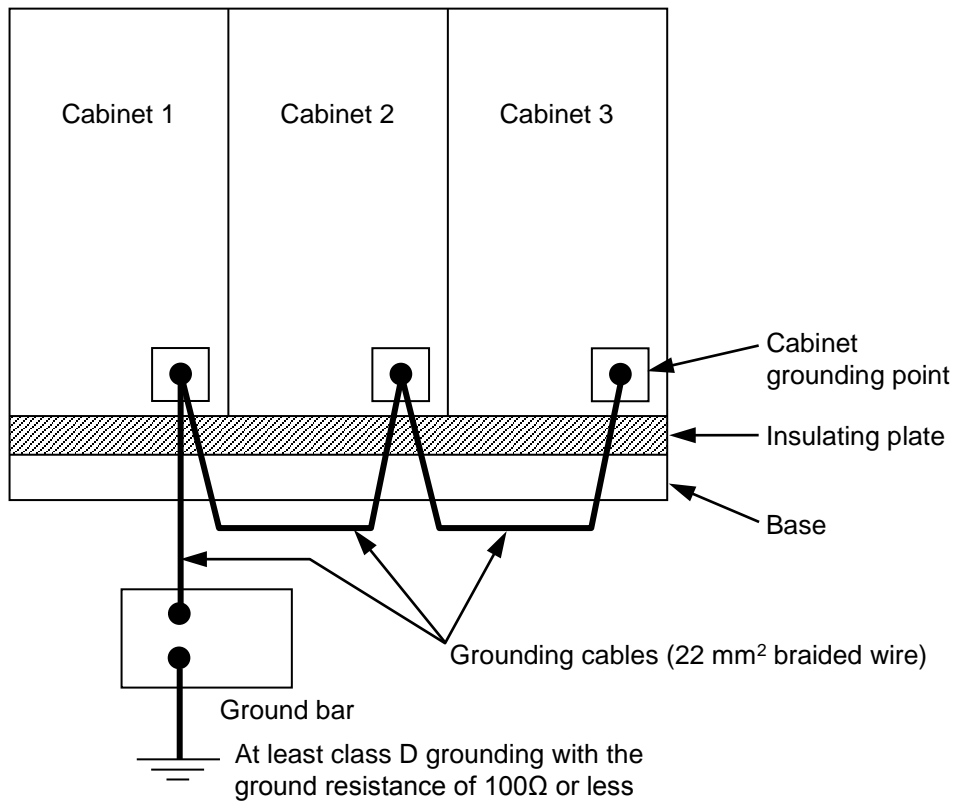

Figure 6-2 Connecting cabinets to ground (multiple cabinets in a row)

Because each cabinet is grounded at a single point, the cabinet must be insulated from the base.

Figure 6-3 shows an example of insulating the base.

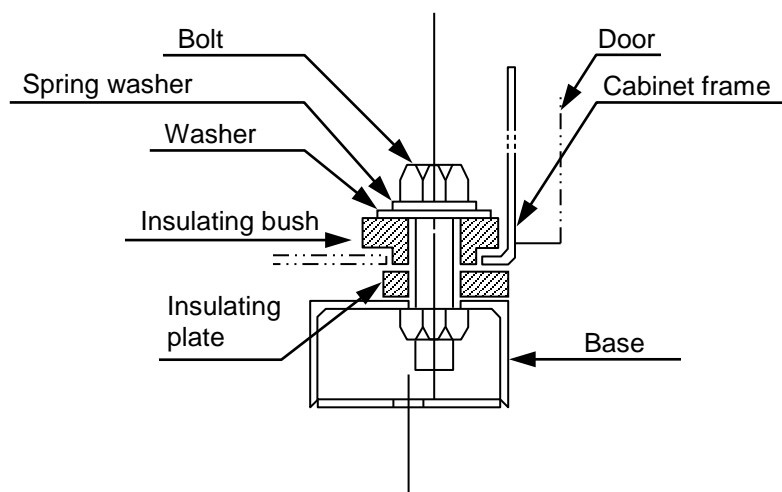

Figure 6-3 Example of base insulation

■ Why is grounding necessary?

- The failure of a transformer or other device might cause high voltage power to travel from a high-voltage device to a low-voltage device. In this situation, a ground connection prevents harm to the operator by electric shock.
- Electromagnetic shielding is used to prevent malfunction of the internal circuits and communication lines of the equipment due to external electromagnetic noise. However, this shielding has no effect unless the shield and cabinet are both grounded.

■ Regions prone to lightning

High-frequency noise and surge voltage can damage the PCs or cause it to malfunction. In regions prone to lightning, take measures to arrest surge voltage. These might include lightning rods and insulating transformers (electrostatically shielded).

■ Cold and hot regions

Operation of the PCs is not guaranteed in environments that are outside the specifications. In particularly cold and hot regions, the temperature or relative humidity of the building or room where the PCs are installed might exceed or fall below the environment specification. In this case, use an air conditioner or heater to adjust the temperature.

■ Wiring using ducts and conduits

If a signal cable of the PCs runs in parallel with the AC cable of another device, use a duct, conduit, or other means to keep the cables separate.

You must ground ducts and conduits without fail.

■ Measures against rats

The key to keeping rats out of the equipment and stopping them from damaging the cables is to eliminate any environments that are hospitable to rats. Specifically, you must curtail their ability to move about, and not leave any food in the area.

Take care when using professional services to eliminate rats. Certain rat repellents can cause problems with the connectors.

6.4 Mounting clearances

To ensure normal operation of the S10VE, you must provide air apertures with air filters at the top and bottom of the cabinet. You must also provide the clearances shown in Figure 6-4 between the cabinet and each unit. When stacking multiple S10VE units or when a heat source is present beneath the S10VE unit, use a shield plate or other means to eliminate the effect of the heat source. If your environment does not allow a shield plate or the like to be added, you must carry out a test run of the system and make sure that the temperature does not exceed 55°C around any unit.

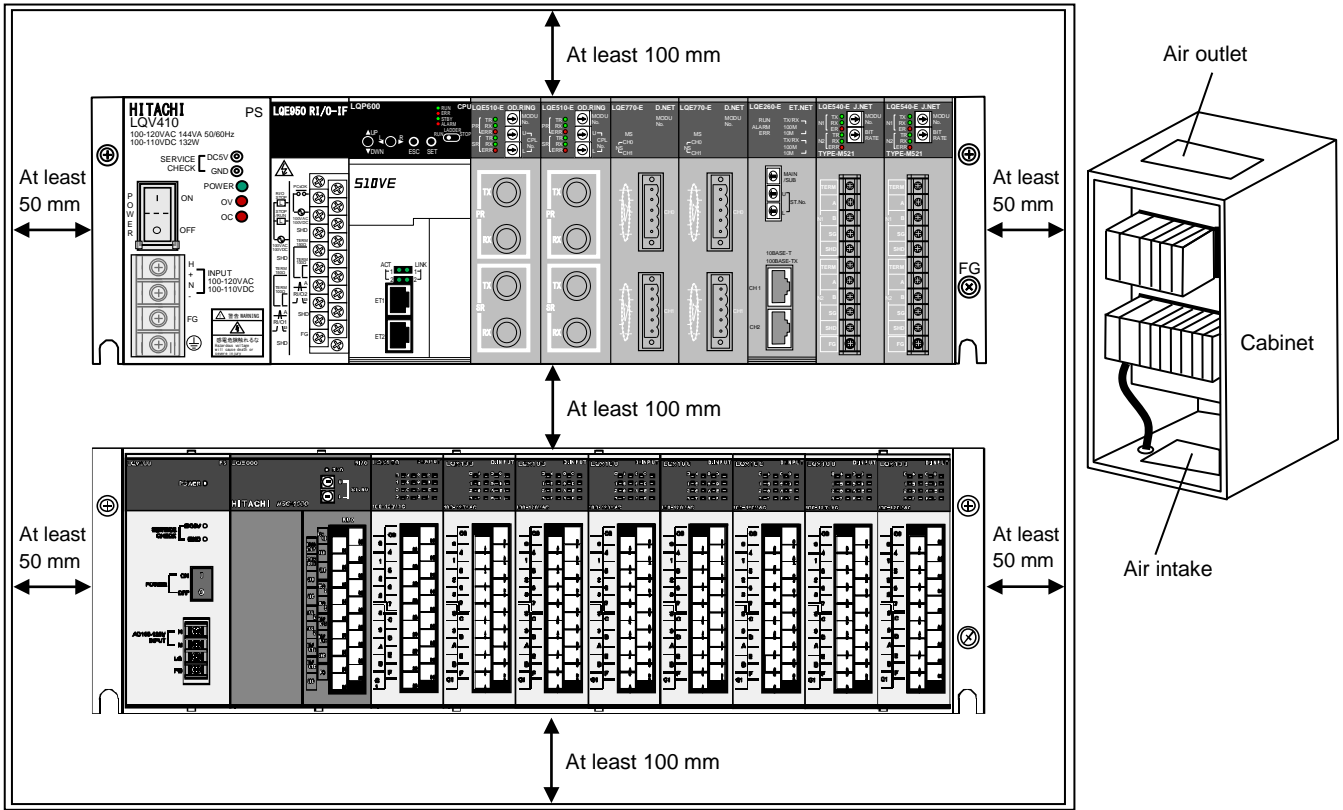

Figure 6-4 Unit mounting clearances

Notice

- To avoid failure or malfunction, leave clearance of at least 100 mm between the cabinet (top and bottom panels) and unit, and between each unit. If you are unable to provide 100 mm of clearance, make sure that the intake air temperature will not exceed 55°C.
- To avoid failure or malfunction, leave clearance of at least 50 mm between the cabinet (side panels) and units. If you are unable to provide 50 mm of clearance, make sure that the intake air temperature will not exceed 55°C.

6.5 External dimensions of mount base

Figure 6-5 shows the external dimensions of the mount base.

For details about external dimensions of option modules, see the following manuals:

- S10VE User's Manual Option OD.RING (LQE510-E) (manual number SEE-1-101)
- S10VE User's Manual Option J.NET (LQE540-E) (manual number SEE-1-102)
- S10VE User's Manual Option D.NET (LQE770-E) (manual number SEE-1-103)
- S10VE User's Manual Option FL.NET (LQE702-E) (manual number SEE-1-104)
- S10VE User's Manual Option ET.NET (LQE260-E) (manual number SEE-1-105)

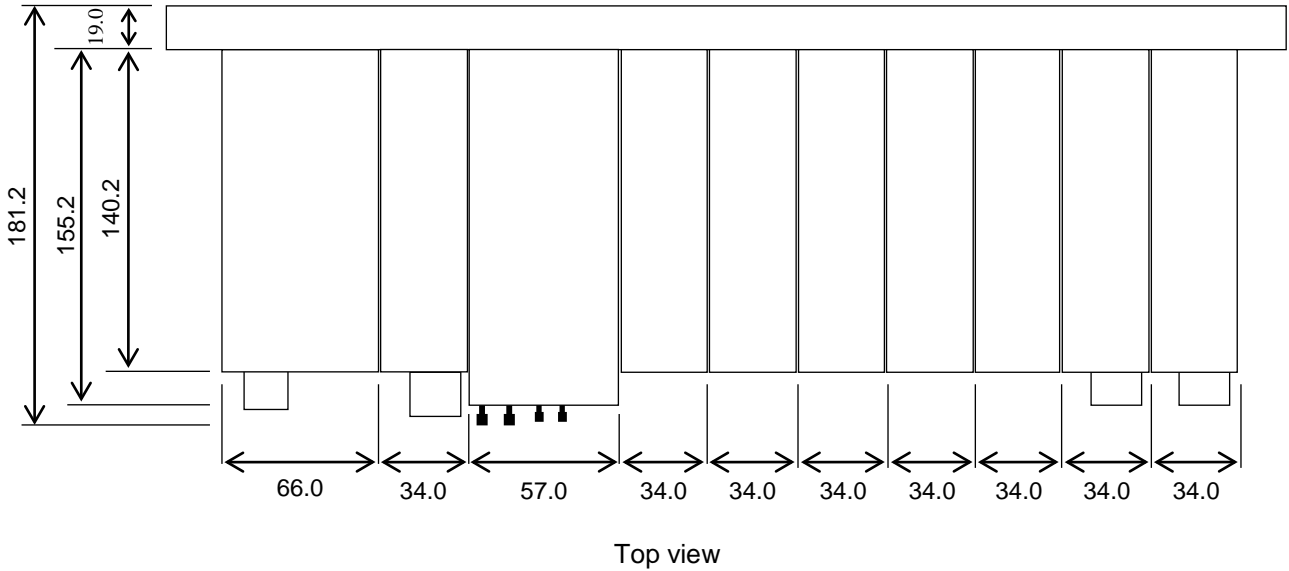
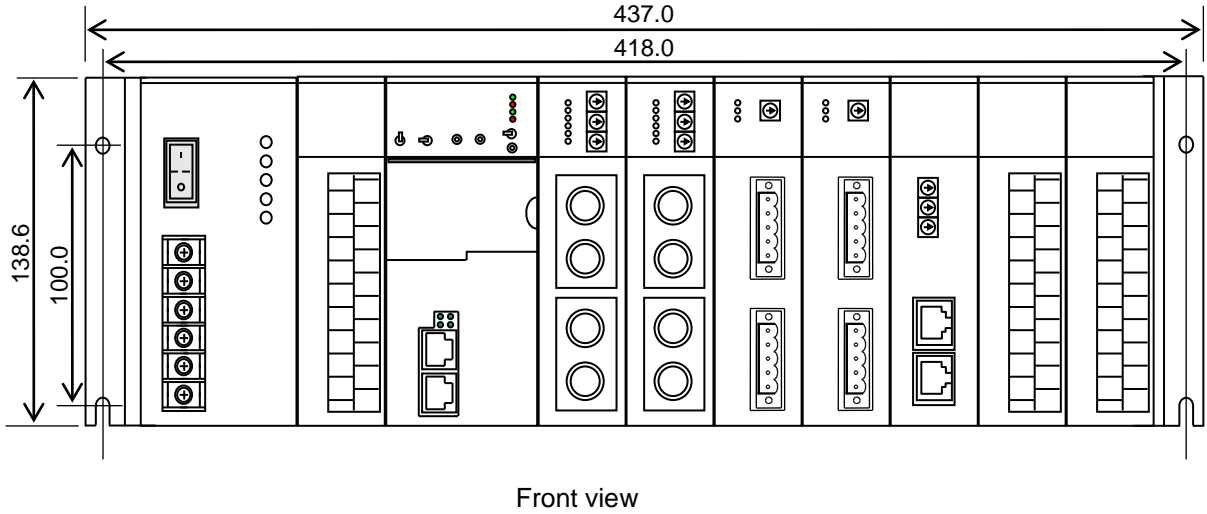

Units: mm

Figure 6-5 External dimensions of S10VE

6.6 Attaching the mount base

Secure the mount base to the upright surface of the cabinet as shown in Figure 6-6. Take care not to install the mount base facing upward, downward, or sideways.

The modules are designed to achieve optimal heat dissipation when the mount base is secured to the upright surface of the cabinet.

When attaching the mount base, do so with no modules mounted to it. If you try to attach the mount base with modules mounted, the resulting increased weight might cause you to lose balance and drop it.

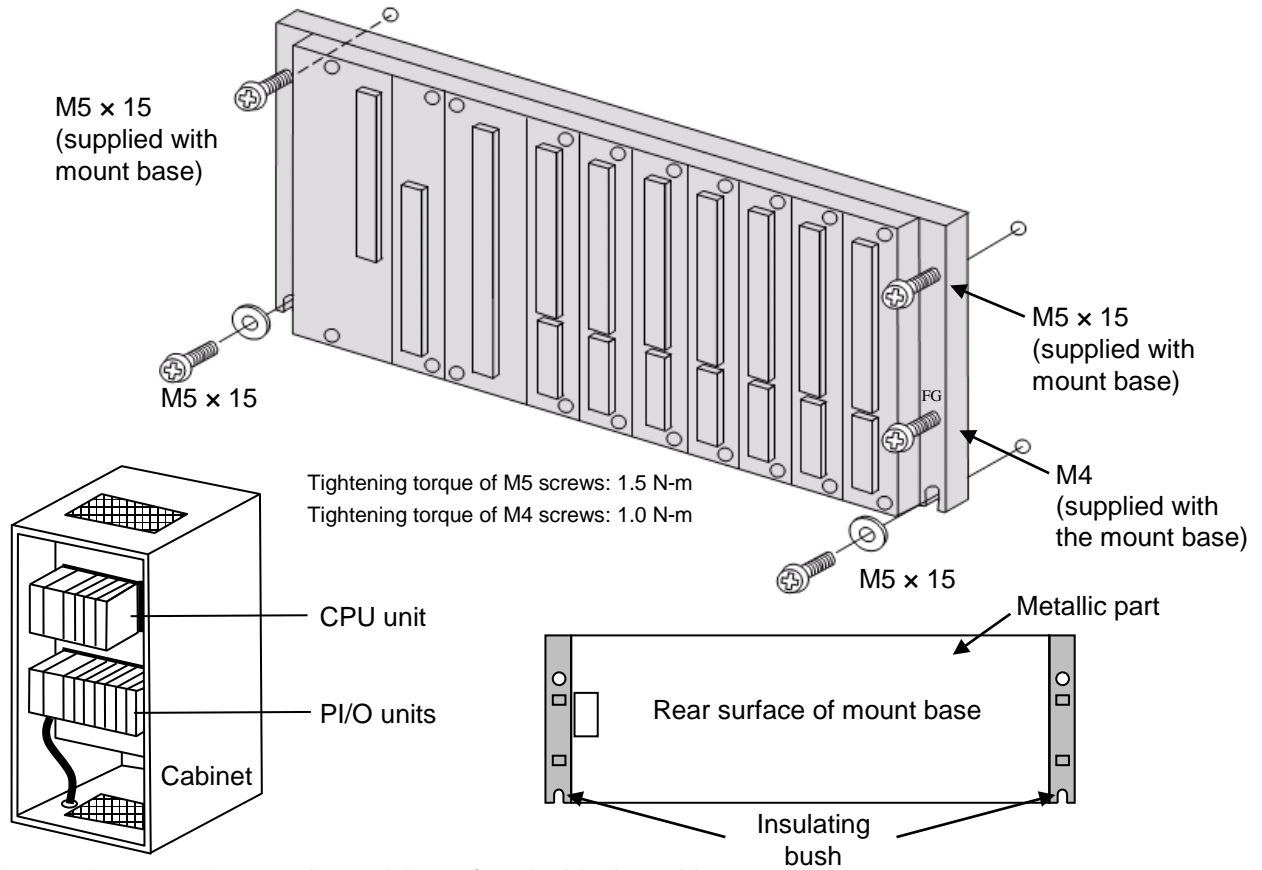

Secure the mount base to the upright surface inside the cabinet. Confirm that the structure does not allow the metallic part of the mount base to contact the control panel.

Figure 6-6 Attaching the mount base

 CAUTION
<ul style="list-style-type: none"> • Do not insert a finger or foreign object into the gap between a connector and the mount base. Doing so might lead to injury or cause the system to malfunction. • Do not attach the mount base to the cabinet with modules already attached to the mount base. Doing so might cause injury or module damage as a result of a module being dropped.

Notice
<ul style="list-style-type: none"> • Secure the mount base to the upright surface inside the cabinet. The rise in temperature that occurs when the mount base is attached anywhere else can damage or degrade the equipment. • To avoid malfunction, do not remove the insulating bushes that insulate the mount base from the cabinet. Confirm that the structure does not allow the metallic part of the mount base to contact the control panel. • The system is not designed to withstand constant vibration or shock. If the system is installed in a location subject to such conditions, isolate the system from sources of vibration or shock, or take anti-vibration measures such as the use of anti-vibration rubber mounts.

6.7 Attaching modules

After attaching the mount base to the cabinet, mount the individual modules to the mount base.

Before attaching a module for the first time, remove the connector caps attached to the connectors on the mount base. When you remove a module from the mount base, reinstate the connector caps to protect the connectors.

Dust and debris can cause malfunction or failure if it enters a connector.

To install the module on the mount base, align it with the module mounting guides (indents in the mount base).

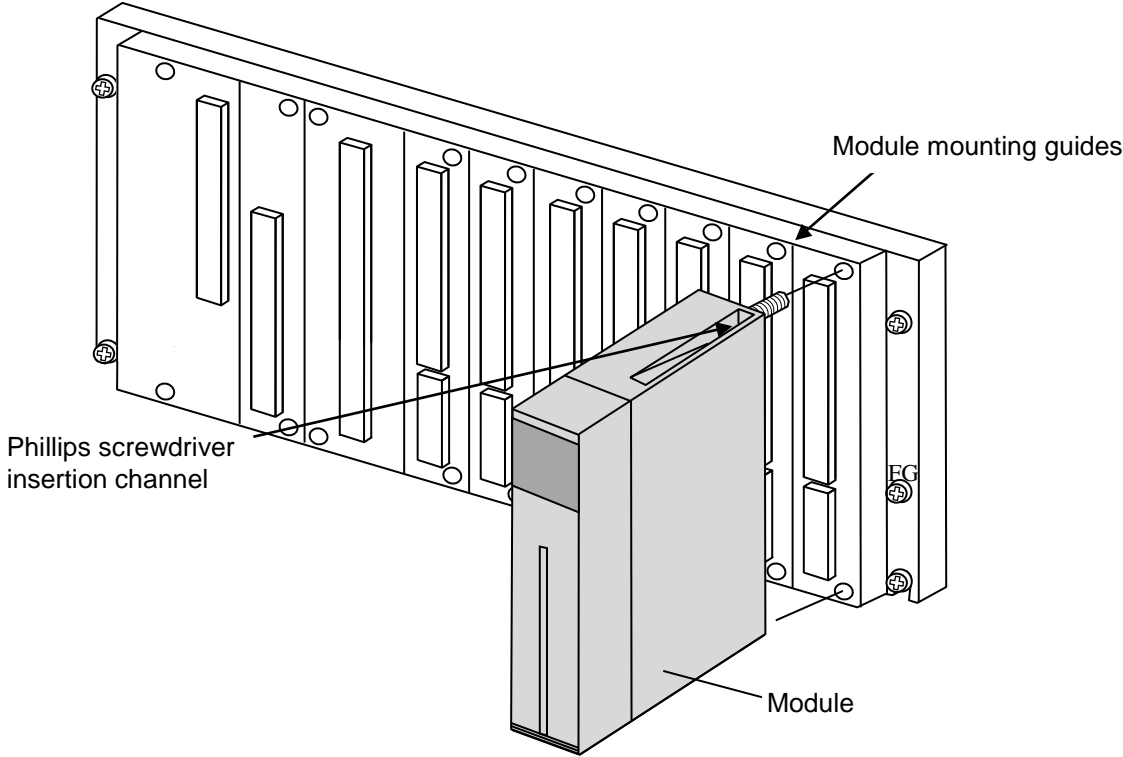

To tighten the module mounting screws, insert a screwdriver into the Phillips screwdriver insertion channels.

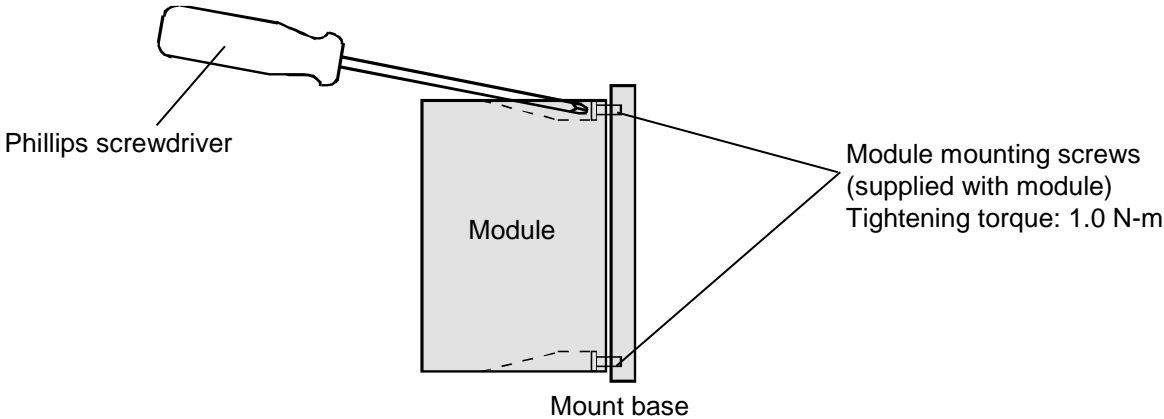

Figure 6-7 Attaching a module

 **WARNING**

- To avoid accident or electric shock, turn off the power switch on the power supply module before removing or installing a module.

 **CAUTION**

- Make sure that the screws are securely tightened. Failing to do so can cause smoke, fire, or malfunction, or cause the module to fall.

Notice

- Static electricity might damage a module or cause it to malfunction. Discharge any static electricity from your body before touching any equipment.
- Poor contact might cause malfunction. Mount the module and connect cabling to the module immediately after the module is unpacked so that dust or other foreign substances do not accumulate on connectors.
- To avoid damaging a module when removing or mounting it, turn off the power switch of the power supply module beforehand.
- To avoid damaging a module, observe the following precautions when mounting or removing the module:
 - Before mounting the module on the mount base connector, check that the connector pins are properly aligned and not bent, broken, or soiled.
 - Connecting or disconnecting a module that is tilted might damage connector pins. When moving the module, hold it vertically parallel to the mount base as shown below.

Bad examples

Good example

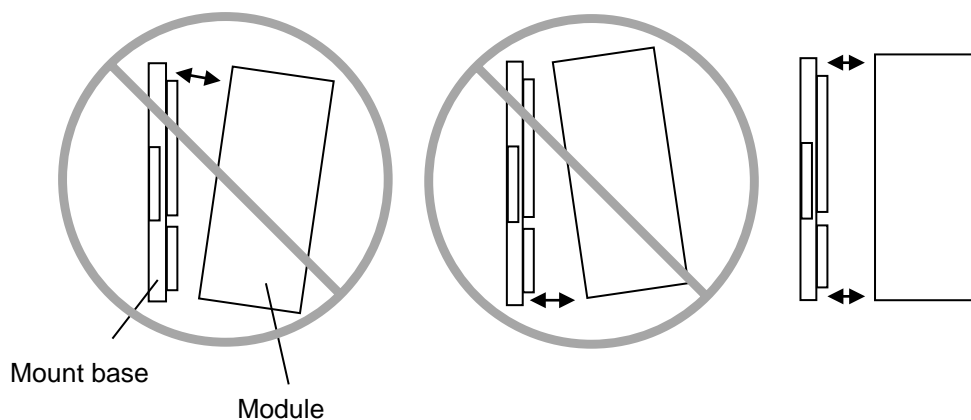

6.8 Connecting the primary battery

The following explains how to connect the primary battery of the S10VE CPU module.
You must connect the primary battery before mounting the CPU module to the mount base.

- (1) Remove the primary battery cover from the left side of the CPU module by pulling on the tab.
- (2) Securely insert the primary battery cables into the primary battery connectors, matching the colors of the cables to those indicated on the CPU module PCB.
- (3) Insert the tab of the primary battery cover into the slot on the CPU module.
- (4) Press the primary battery cover until you hear a click.

Primary battery

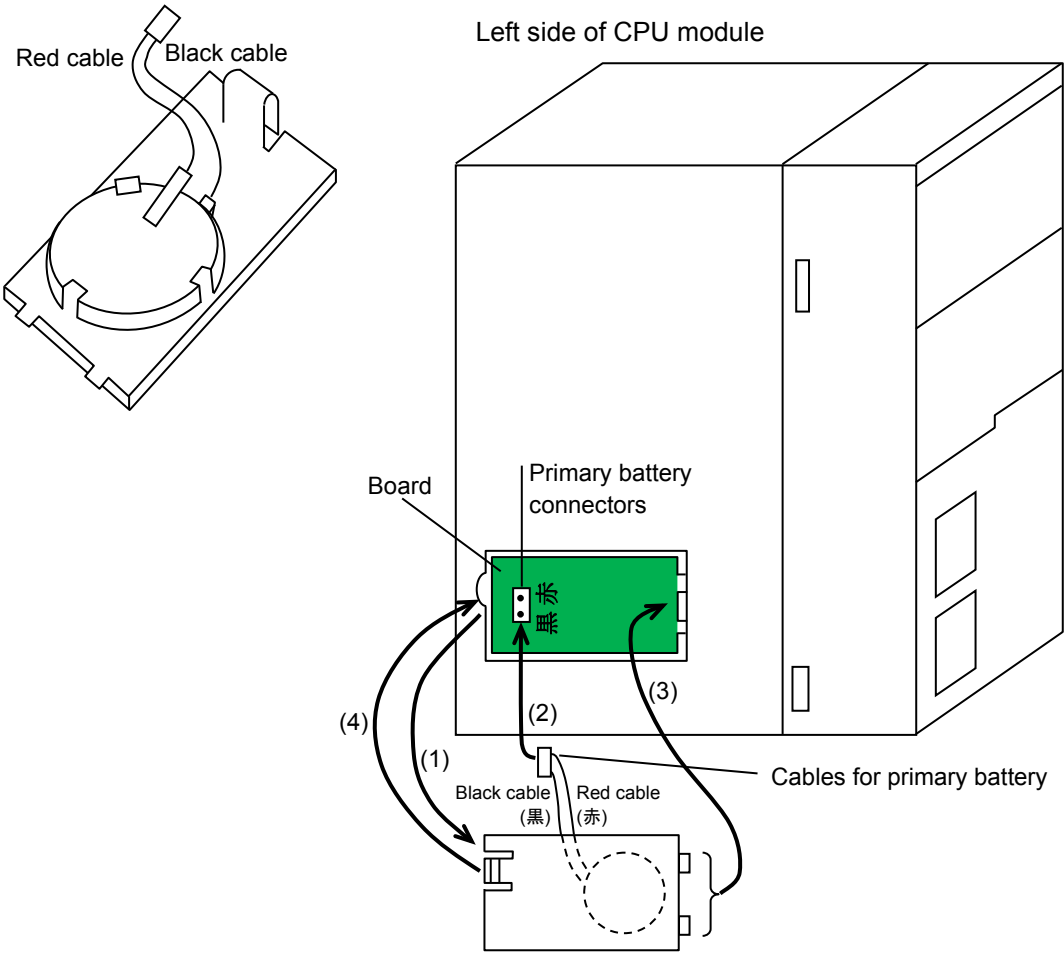



Figure 6-8 Primary battery connection procedure

 WARNING
<ul style="list-style-type: none">• Do not put the primary battery cables between the primary battery cover and the CPU module. Doing so might result in shorting due to disconnection, causing deformation, leakage, heat generation, explosion, or fire.

6.9 Mounting modules

Figure 6-9 illustrates how modules are mounted in the system.

PS slot: Used to mount the power supply module.

CPU slot: Used to mount the CPU module.

I/O slots: Used to mount option modules or PI/O modules (a maximum of 7).

IF slot: Used to mount the RI/O-IF module.

- Example of mount base (HSC-1770)

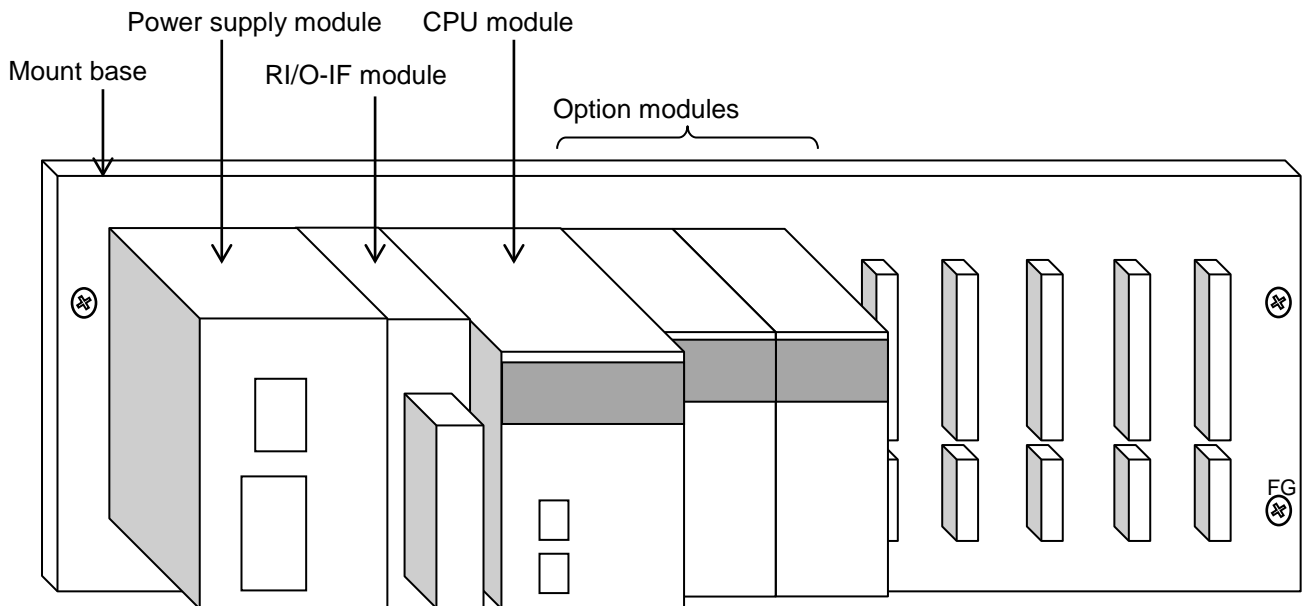

Figure 6-9 External view of mount base

Notice

- Mounting a module to the wrong slot can damage the equipment. Mount the power supply module, CPU module, and RI/O-IF module to its dedicated slot and no other.

6.10 Restrictions on mounting option modules

Restrictions apply to the mounting of option modules in terms of current consumption and communication times.

The following explains the restrictions that apply when mounting option modules.

(1) Restrictions on the number of option modules that can be mounted

Table 6-1 shows the maximum number of option modules that can be mounted to a CPU unit. The total current consumption of all modules (including the CPU module, RI/O-IF module, option modules, and PI/O modules) is limited to 10A or less. For details about the current consumption of each module, see *6.12 Current consumption calculation table*.

Table 6-1 Restrictions on number of option modules

Name	Model	Maximum number of modules per CPU unit	Remarks
PS (AC power supply)	LQV410	1	PS slot only
RI/O-IF	LQE950	1	IF slot only
CPU	LQP600	1	CPU slot only
FL.NET	LQE702-E	2	
OD.RING	LQE510-E	2	
J.NET	LQE540-E	4	
D.NET	LQE770-E	4	
ET.NET	LQE260-E	2	

(2) Mounting restrictions based on communication times

Option modules, such as OD.RING and D.NET, periodically update I/O data at their respective communication times. The CPU module uses the I/O data updated by each option module in the ladder program to control applications. The ladder program runs repeatedly at a fixed interval (sequence cycle). To prevent I/O data from being dropped, the communication time of each option module must be no more than half the sequence cycle. The communication time of an option module is determined by the communication word setting of the individual option module, and the number of option modules the CPU unit handles. For details on how to calculate the communication time of an option module, see the manual for that module.

6.11 Restrictions on mounting PI/O modules to the CPU unit

Observe the following restrictions when mounting PI/O modules to the CPU unit:

(1) Restrictions when mounting PI/O modules to the CPU unit

- If option modules and PI/O modules are mounted to the CPU unit, arrange the modules in such a way that each is grouped with its own kind.
- Mount the PI/O modules in such a way that analog and low-voltage PI/O modules (modules with an output of 24 V DC or less) are separate from high-voltage PI/O modules (modules with an output of at least 100 V AC or 48 V DC).
- Leave at least one empty slot between a high-voltage PI/O module (module with an output of at least 100 V AC or 48 V DC) and a CPU module, option module, or analog module. You do not need to leave an empty slot between high and low-voltage modules.
- When mounting a PI/O module to the CPU unit, take precautions to prevent noise from affecting the PI/O module. For example, you might insert a buffer relay equipped with a surge absorber into each signal line.
- When mounting a PI/O module to the CPU unit, use a supply voltage of 100 V AC even if the specification of the PI/O module permits both 100 V and 200 V AC. You cannot use a 200 V AC power supply.

The following ((a) to (e)) are examples of mounting modules to the CPU unit:

- (a) When mounting a 100 V AC/48 V DC or higher PI/O module to the CPU unit, leave at least one empty slot between the CPU module and the PI/O module.

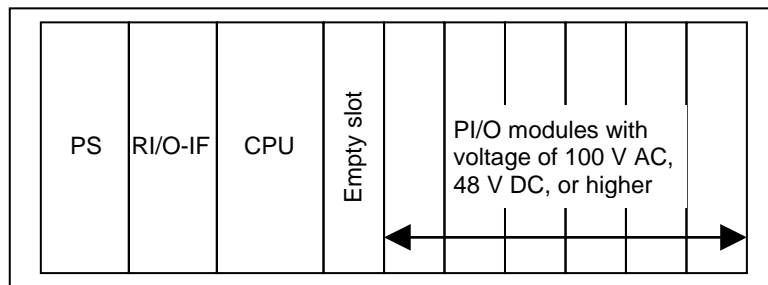

- (b) When mounting PI/O modules with a voltage of 24 V DC or lower to the same CPU unit as PI/O modules with a voltage of 100 V AC/48 V DC or higher, mount each in a group with its own kind.

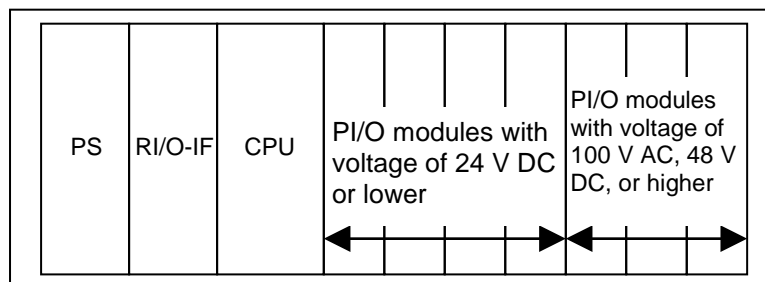

- (c) When mounting analog modules to the same CPU unit as PI/O modules with a voltage of 100 V AC/48 V DC or higher, leave at least one empty slot between the analog modules and the PI/O modules.

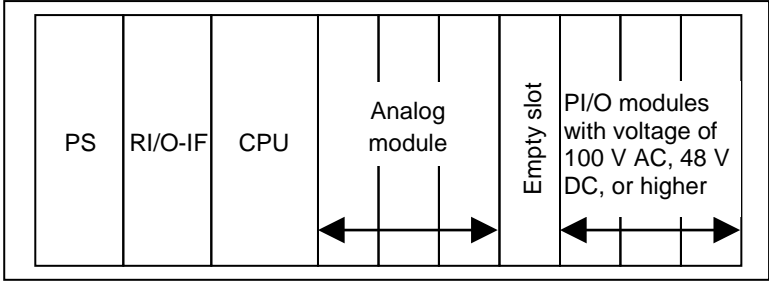

- (d) When mounting option modules and PI/O modules to the same CPU unit, mount each in a group with its own kind.

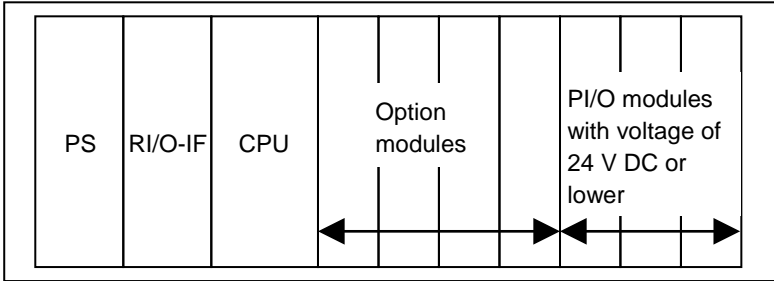

- (e) When mounting option modules to the same CPU unit as PI/O modules with a voltage of 100 V AC/48 V DC or higher, leave at least one empty slot between the option modules and the PI/O modules.

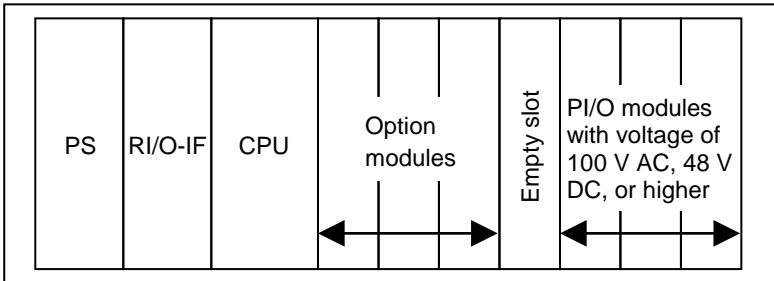

Notice

- Failing to observe the PI/O module mounting restrictions can lead to malfunction.

6. Installation

(2) Restrictions on the number of PI/O modules mounted to a CPU unit

Table 6-2 shows the maximum number of PI/O modules that can be mounted to a CPU unit.

Table 6-2 Restrictions on number of PI/O modules

Name	Model	Maximum number of modules per CPU unit	Remarks
Digital input	LQX130	6 ^{#1}	
	LQX200	7	
	LQX240	6 ^{#1}	
	LQX300	7	
	LQX350	7	
Digital output	LQY100	6 ^{#2}	
	LQY140	6 ^{#2}	
	LQY200	7	
	LQY300	7	
	LQY350	7	
Digital input/output	LQZ300	7	
Pulse counter	LQC000	7	
Analog input	LQA000	7	
	LQA100	7	
Analog output	LQA500	7	

- #1: The restriction that there must be an empty slot between the CPU and any high-voltage module means a maximum of six PI/O modules can be mounted.
- #2: When using 100 V AC or 100 V DC as the power supply voltage of the PI/O modules, an empty slot must be left between the CPU module and the PI/O modules. This means that a maximum of six PI/O modules can be mounted. When using a 24 V DC power supply for the PI/O modules, the maximum number of PI/O modules that can be mounted is seven.

6.12 Current consumption calculation table

Table 6-3 shows the current consumption values for each module.

A system is only viable if the total of the current values of its modules is less than the current capacity of the power supply.

If the proposed system configuration exceeds the current capacity of the power supply, you will need to remove one or more modules from the system.

Table 6-3 Current consumption calculation table

Name	Model	Current consumption value per unit [#]	Number of modules mounted	Total 5V current consumption value (mA)	Judgment value
CPU	LQP600	3,100 mA			
RI/O-IF	LQE950	200 mA			
OD.RING	LQE510-E	900 mA			
J.NET	LQE540-E	900 mA			
FL.NET	LQE702-E	1,300 mA			
D.NET	LQE770-E	700 mA			
ET.NET	LQE260-E	1,300 mA			
OPT RI/O	LQZ410	410 mA			
DI	LQX130	70 mA			
DI	LQX200	80 mA			
DI	LQX240	110 mA			
DI	LQX300	150 mA			
DI	LQX350	170 mA			
DO	LQY100	780 mA			
DO	LQY140	400 mA			
DO	LQY200	120 mA			
DO	LQY300	260 mA			
DO	LQY350	400 mA			
DI/DO	LQZ300	300 mA			
Pulse counter	LQC000	150 mA			
AI (voltage input)	LQA000	580 mA			
AI (current input)	LQA100	580 mA			
AO (voltage output)	LQA500	530 mA			
Power supply (PS)	LQV410				Max. 10,000 mA

[#]: This value is the maximum current consumption of each module.

This page is intentionally left blank.

7. Wiring

Before attaching or removing the terminal block or any cables, you must turn off the PLC unit and external power supply.

7.1 Cable specifications

Table 7-1 lists the specifications for communication cables, power cables, and ground cables. Table 7-2 lists the cables we recommend.

For details on how to wire a particular option module, see the manual for that option module.

- S10VE User's Manual Option OD.RING (LQE510-E) (manual number SEE-1-101)
- S10VE User's Manual Option J.NET (LQE540-E) (manual number SEE-1-102)
- S10VE User's Manual Option D.NET (LQE770-E) (manual number SEE-1-103)
- S10VE User's Manual Option FL.NET (LQE702-E) (manual number SEE-1-104)
- S10VE User's Manual Option ET.NET (LQE260-E) (manual number SEE-1-105)

Table 7-1 Cable specifications

Item		Specification		Remarks
Ethernet		Cable type	Category 5e or better UTP cable	
		Cable length	Maximum 100 m	
Remote I/O	Long distance (maximum 300 m per line)	Characteristic impedance	150Ω	
		Attenuation factor	10 dB/km (750 kHz)	
		Diameter	0.75 mm ² (recommended cable: CO-EV-SX 2 × 0.75SQ LF) 0.3 mm ² (recommended cable: CO-EV-SB 1P × 0.3SQ LF)	
		Terminating resistance	150Ω	
	Medium distance (maximum 200 m per line)	Characteristic impedance	150Ω	
		Attenuation factor	12 dB/km (750 kHz)	
		Diameter	0.18 mm ² (recommended cable: CO-EV-SB 1P × 0.18SQ LF)	
	Short distance (maximum 100 m per line)	Terminating resistance	150Ω	
		Characteristic impedance	100Ω	
		Attenuation factor	21 dB/km (750 kHz)	
		Diameter	0.3 mm ² (recommended cable: CO-SPEV-SB(A) 1P × 0.3SQ LF)	
	PCsOK	Terminating resistance	100Ω	
Cable type		Shielded twisted pair		
Cable length		Maximum 100 m		
STOP/RUN, RI/O STOP	Diameter	0.5 mm ²		
	Cable type	Shielded twisted pair		
	Cable length	Maximum 100 m		
Power supply	Diameter	0.5 mm ²		
	Cable type	Shielded twisted pair or twisted three wire cable		
Ground	Diameter	2 mm ² or more	Depends on the load and cable length.	

Table 7-2 Recommended cables

Item		Cable	Remarks
Ethernet		NETSTAR-C5E	Manufactured by Hitachi Metals, Ltd.
Remote I/O	Long distance (maximum 300 m per line)	CO-EV-SX 2 × 0.75SQ LF CO-EV-SB 1P × 0.3SQ LF	Manufactured by Hitachi Metals, Ltd.
	Medium distance (maximum 200 m per line)	CO-EV-SB 1P × 0.18SQ LF	Manufactured by Hitachi Metals, Ltd.
	Short distance (maximum 100 m per line)	CO-SPEV-SB(A) 1P × 0.3SQ LF	Manufactured by Hitachi Metals, Ltd.

7.2 Wiring standards

This section explains the wiring standards for the S10VE.

7.2.1 Terminal block and solderless terminals

Figure 7-1 to Figure 7-5 show the terminal block and solderless terminals used with the S10VE.

- 18-point terminal block

Solderless terminal type: M3

Applicable module name: RI/O-IF

Applicable module model: LQE950

Tightening torque: 0.6 N-m

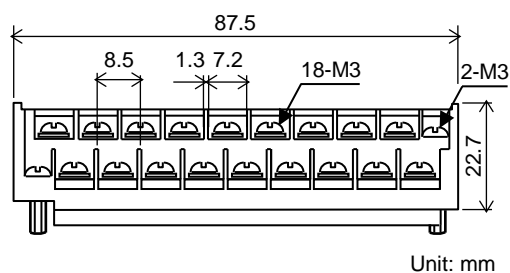

Unit: mm

Figure 7-1 18-point terminal block

- 11-point terminal block

Solderless terminal type: M3

Applicable module name: J.NET (JPCN-1 line)

Applicable module model: LQE540-E

Tightening torque: 0.6 N-m

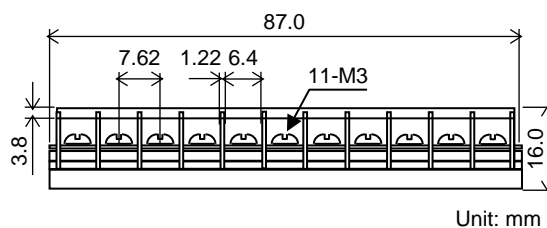

Unit: mm

Figure 7-2 11-point terminal block

7. Wiring

■ 4-point terminal block

Solderless terminal type: M3

Applicable module name: Power supply (100 V AC or DC)

Applicable module model: LQV410

Tightening torque: 0.6 N-m

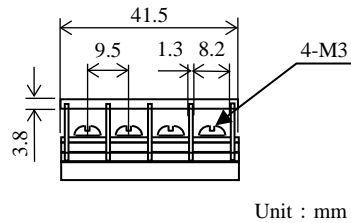

Figure 7-3 4-point terminal block

■ Compatible solderless terminals

You must use M3 terminals (such as V1.25-3 and 1.25-YS3A) for the solderless terminals.

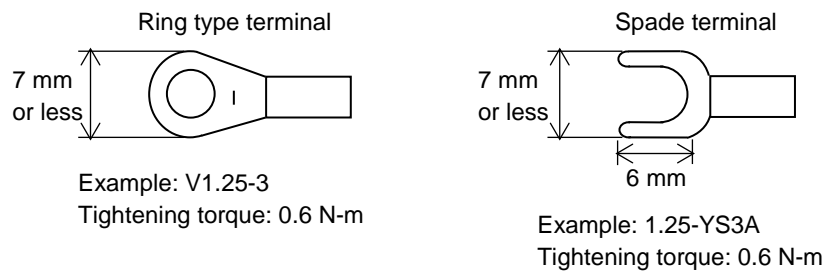

Figure 7-4 Compatible solderless terminal

The cable sheath ends and the wire ends that connect to the solderless terminals must be protected to prevent inadvertent contact. You might use an insulating cap, heat-shrunk tube, or insulating tape, for example.

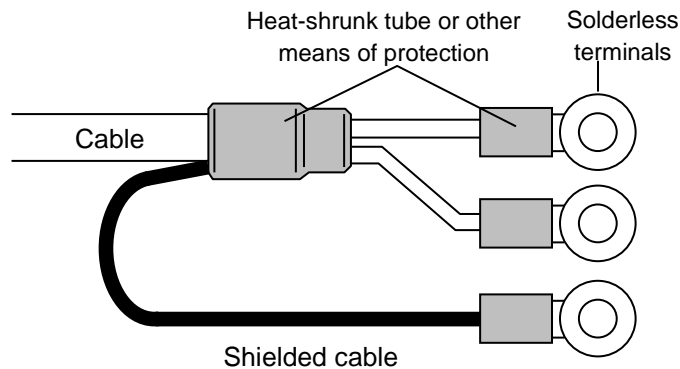

Figure 7-5 Connecting solderless terminals to cables

7.2.2 Attaching the terminal block

Attach the terminal block (18-point) by performing the steps explained in this section. Failing to follow the correct procedure might cause incomplete connections or damage to the terminal block.

Note that the 11-point and 4-point terminal blocks are permanently fixed to the module and cannot be removed.

■ Step 1

Insert the terminal block (18-point) into the module. Open the terminal block cover and hold the cover in the open position, and then attach the terminal block as explained in Step 2.

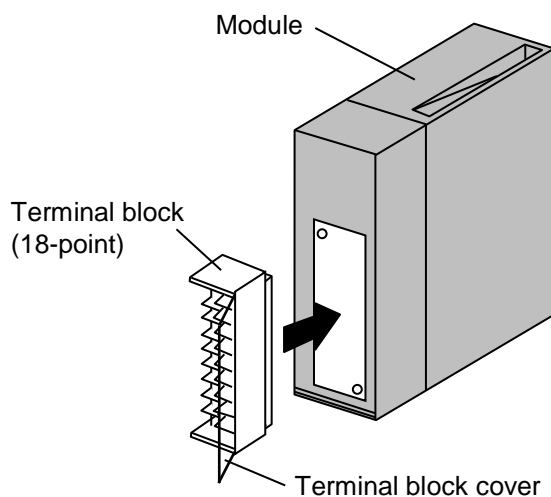

■ Step 2

Attach the terminal block (18-point) to the module. Tighten one screw by a small amount, and then the other by an equivalent amount, repeating this process until the terminal block is fully attached to the module.

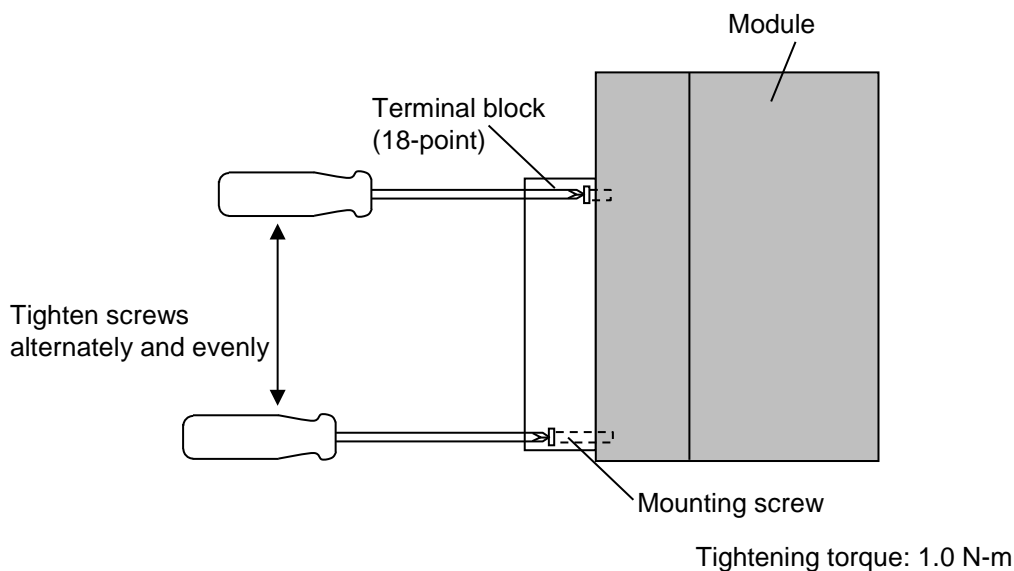

Note: To remove the terminal block, perform these steps in reverse.

7.3 Power supply wiring

The input power supply of the S10VE must be insulated from the control power supply by an electrostatic-shielded insulating transformer.

Figure 7-6 and Figure 7-7 show the wiring configuration when the insulating transformer is installed on the power distribution panel and the S10VE panel (PCs panel), respectively. For details about wiring, see 7.4 *Ground wiring*.

- When insulating transformer is installed on power distribution panel

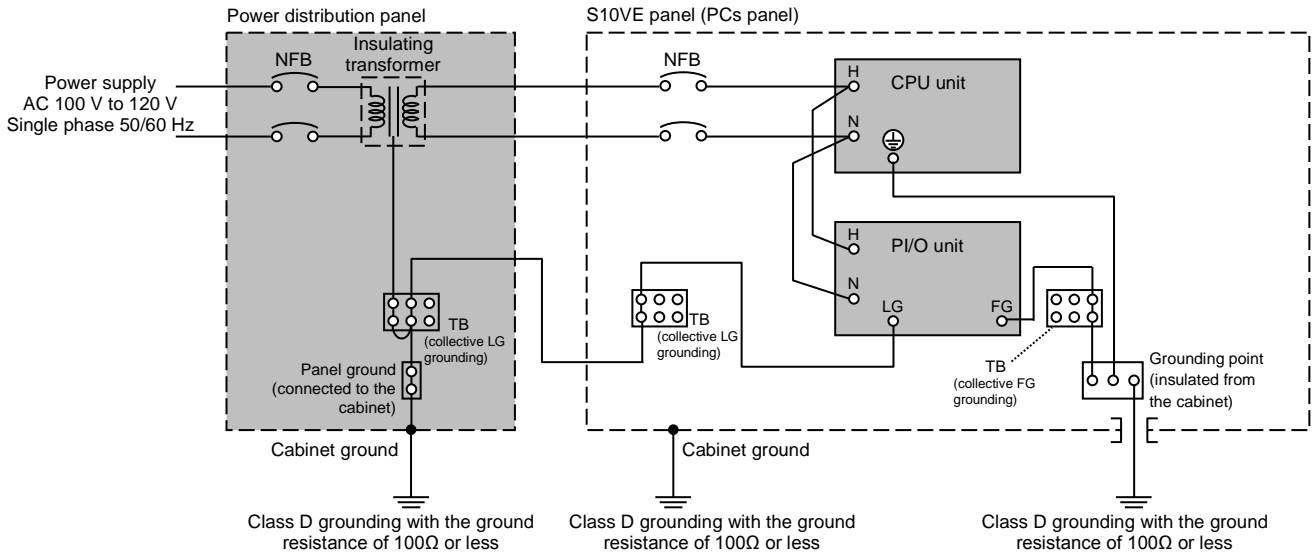

Figure 7-6 Power supply wiring (with insulating transformer installed on power distribution panel)

- When insulating transformer is installed on S10VE panel (PCs panel)

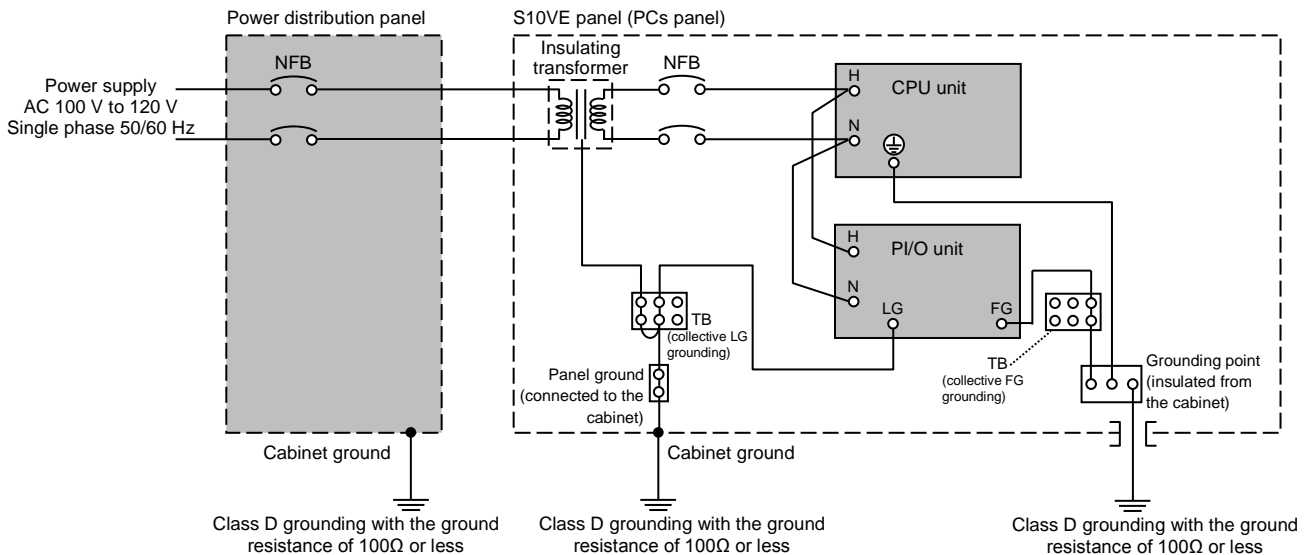

Figure 7-7 Power supply wiring (with insulating transformer installed on S10VE panel (PCs panel))

- The grounding point of the S10VE must be insulated from the cabinet.
- The mount base must be insulated from the cabinet.
- Cable diameter:
 - Power cables: 2 mm² or more
 - Ground wires: 2 mm² or more inside cabinet
5.5 mm² or more outside cabinet

■ Example of internal panel wiring

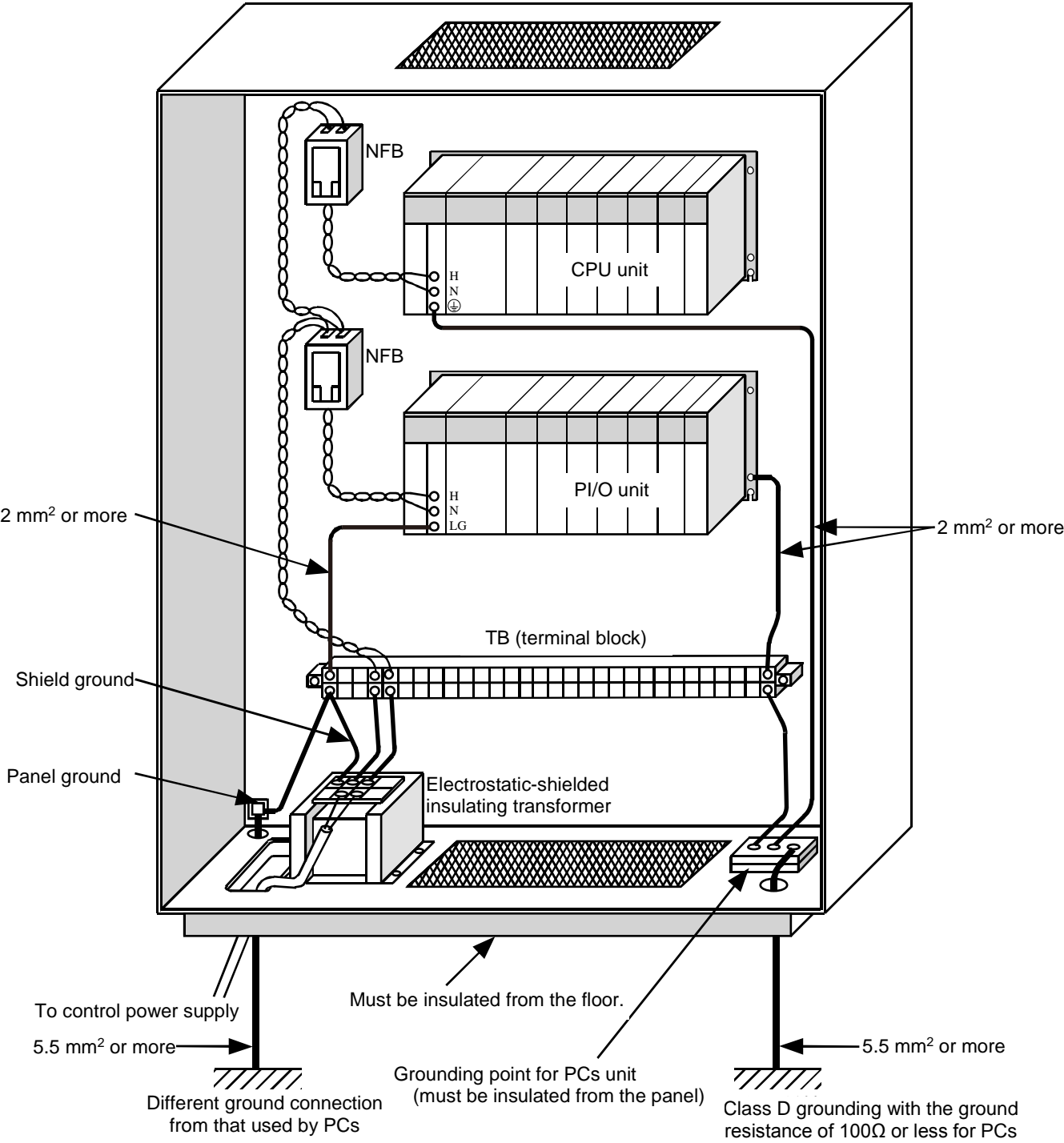

Figure 7-8 Example of internal panel wiring

7.4 Ground wiring

Figure 7-9 and Table 7-3 describe ground wiring.

- In the CPU unit, connect the protective grounding terminal (⊕) of the power supply module to the grounding point.

The FG terminals of the RI/O-IF module and option modules must be connected to the FG terminal of the power supply module by using daisy-chain wiring with FG terminals of adjacent modules and the FG terminal of the mount base.

The protective grounding terminal (⊕) and FG terminal of the power supply module are connected inside the power supply module. The FG terminals of modules are grounded via the protective grounding terminal (⊕) of the power supply module.
- In the PI/O unit, connect the LG terminal of the power supply module according to 7.3 Power supply wiring.

The connection points depend on the location of the insulating transformer. Connect the FG terminal of the power supply module to the FG terminal of the mount base, and then connect the FG terminal of the mount base to the grounding point. Keep the LG and FG separate to prevent one from interfering with the other.
- The cabinet grounding point must be provided with class D grounding with the ground resistance of 100Ω or less.

- Example of the mount base (model: HSC-1770)

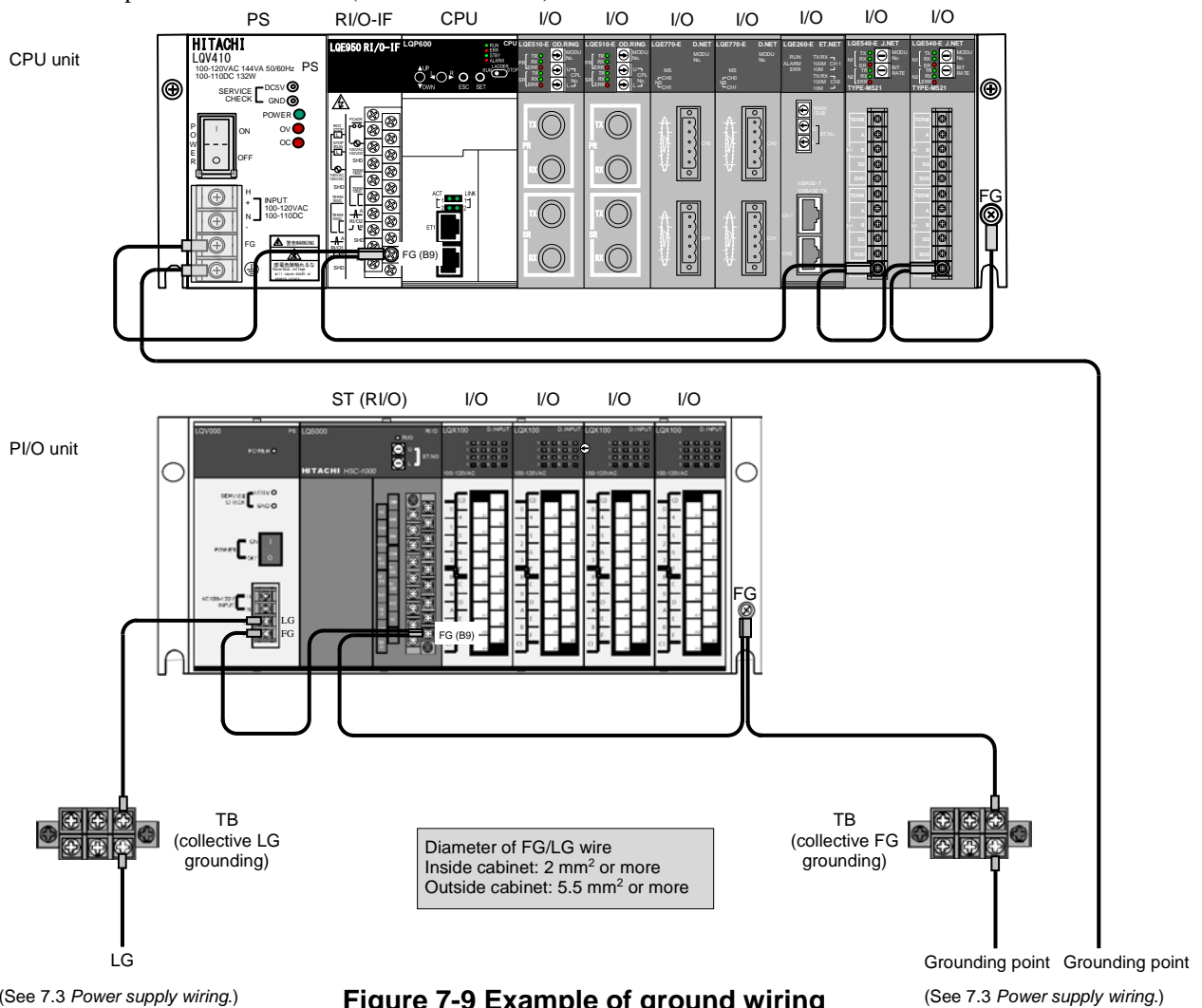

Notice

- The grounding system of the CPU unit differs from that of the PI/O unit. To avoid malfunction or damage to a module, confirm that the wiring is correct.

Table 7-3 List of ground wiring requirements

No.	Name	Item	Description
1	Power supply	FG terminal grounding	Connect the FG terminals of adjacent modules together in a daisy chain, and then connect the end of the daisy chain to the FG terminal of the mount base (wire diameter: 2 mm ² or more).
		Protective grounding terminal (⊕)	Connect the protective grounding terminal to the cabinet grounding point, and finally to class D grounding with a ground resistance of 100Ω or less (cabinet interior wire diameter 2 mm ² or more, and exterior wire diameter 5.5 mm ² or more).
2	RI/O-IF	Remote I/O shield grounding	Connect the FG terminals of adjacent modules together in a daisy chain, and then connect the end of the daisy chain to the FG terminal of the power supply module (wire diameter: 2 mm ² or more).
3	Mount base	FG terminal wire	Connect the FG terminals of adjacent modules together in a daisy chain, and then connect the end of the daisy chain to the FG terminal of the power supply module (wire diameter: 2 mm ² or more).
4	Shield grounding of option modules	FL.NET and ET.NET	No shielded cables are used.
		D.NET cable shield grounding and J.NET module FG terminal grounding	Connect the FG terminals of adjacent modules together in a daisy chain, and then connect the end of the daisy chain to the FG terminal of the power supply module (wire diameter: 2 mm ² or more).
		OD.RING	No shielded cables are used. Cover the optical connectors with an insulating material such as rubber.
5	Shield grounding of PI/O modules	Digital input/digital output module	No shielded cables are used. Alternatively, if using shielded cables, connect the FG terminals of adjacent modules together in a daisy chain, and then connect the end of the daisy chain to the FG terminal of the power supply module (wire diameter: 2 mm ² or more).
		FG terminal of the analog input/analog output module	Connect the FG terminals of adjacent modules together in a daisy chain, and then connect the end of the daisy chain to the FG terminal of the power supply module (wire diameter: 2 mm ² or more).

Notice

- Noise can cause the system to malfunction. Make sure that the protective grounding terminal (⊕) is grounded.
- To avoid malfunction, the mount base must be insulated from the cabinet. Do not remove the insulating bushes from behind the mount base.
- Connect the FG terminals of adjacent modules and mount base in a daisy chain, and then connect the end of the daisy chain to the FG terminal of the power supply module.
- Do not connect the FG terminal of a module to a mount base fixing screw.

7.5 Wiring the power supply module

Figure 7-10 shows the wiring of the power supply module. Figure 7-11 shows the input terminal connections.

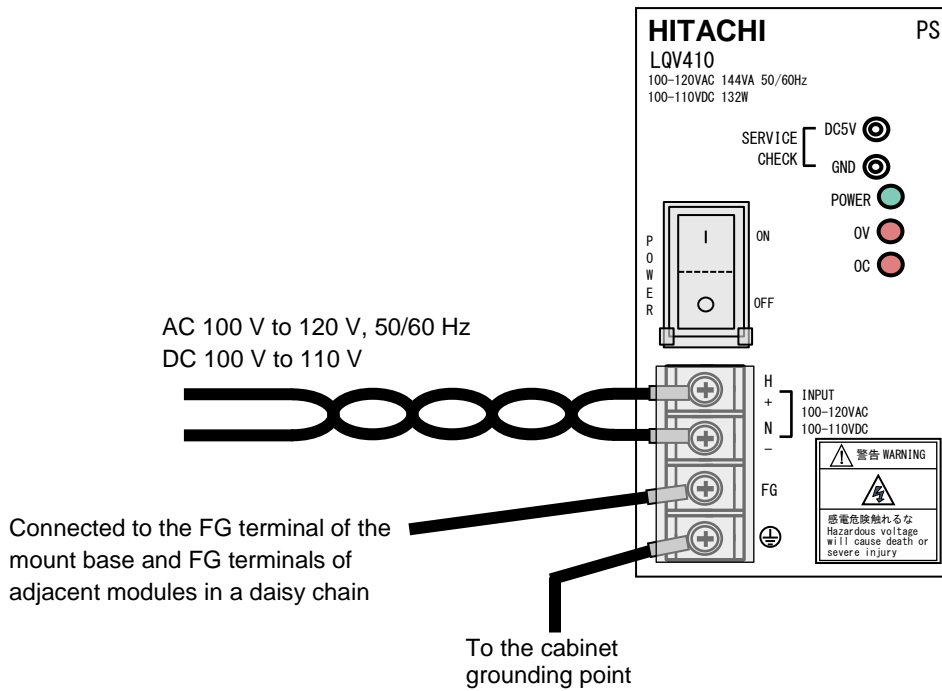

Figure 7-10 Wiring of power supply module

Terminal block

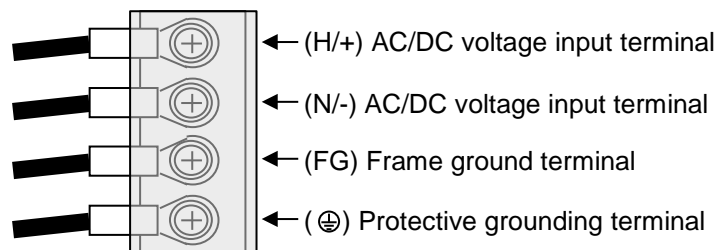

Figure 7-11 Input terminal connection diagram

In high-noise environments, insert an insulating transformer or noise filter as shown in Figure 7-12.

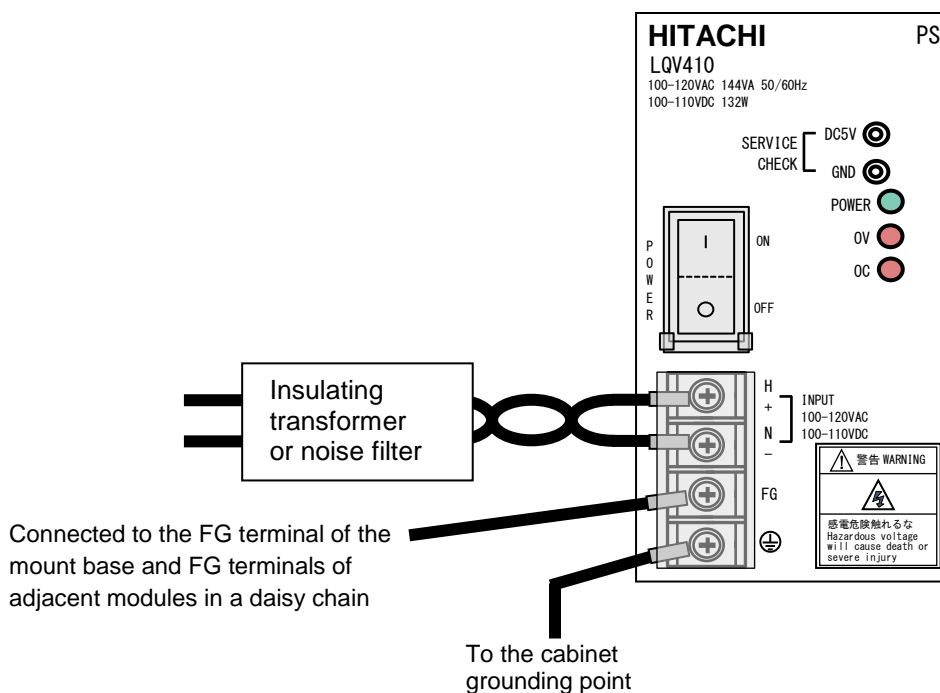



Figure 7-12 Power module wiring in high-noise environment

DANGER

- Electric shock might cause death. Make sure that the protective grounding terminal () is connected to ground.

WARNING

- To avoid electric shock, accident, or malfunction, make sure that the power switch of the power supply module is off before connecting or disconnecting any cables. Re-attach the terminal cover as soon as you have completed the wiring.

7. Wiring

7.6 Wiring for external I/O signals of the RI/O-IF module

Figure 7-13 and Figure 7-14 show the wiring for the external I/O signals of the RI/O-IF module.

7.6.1 Wiring for PCsOK signal

Figure 7-13 shows the wiring for the PCsOK signal.

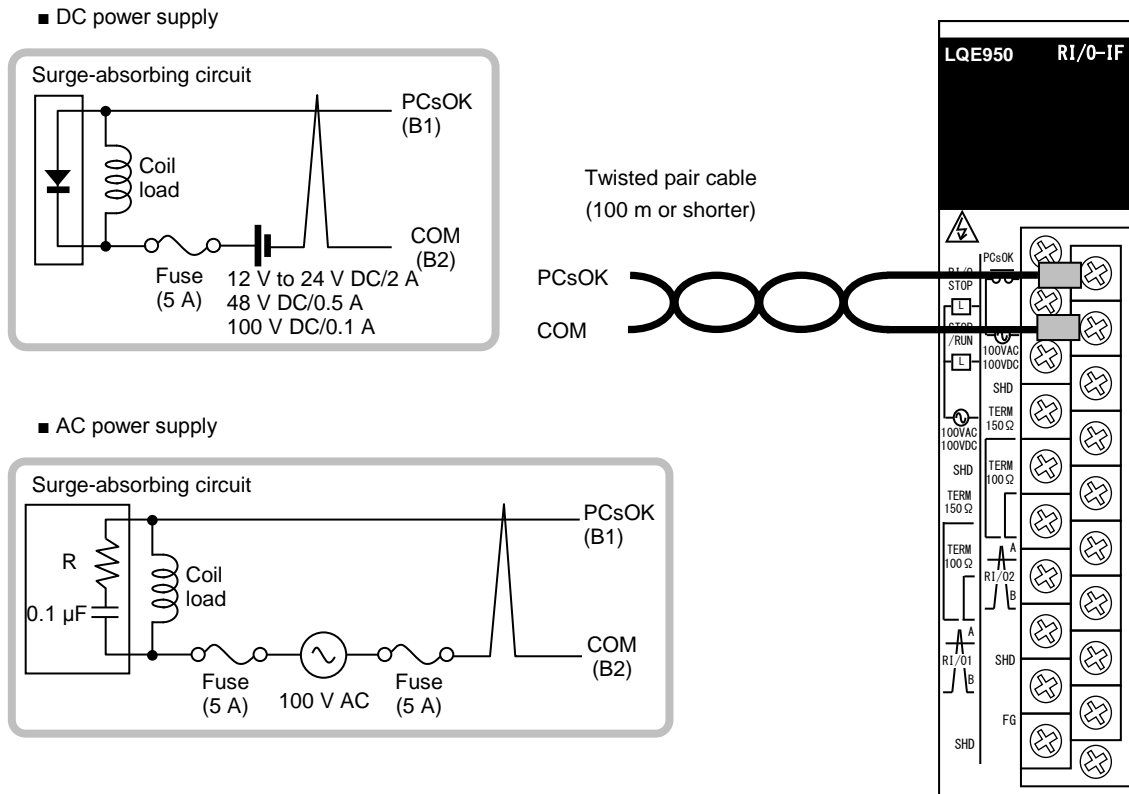

Figure 7-13 Wiring for PCsOK signal

⚠ WARNING

- To avoid fire, place fuses on both sides of the AC power supply. This protects the system if the PCsOK or COM line shorts to FG.

7.6.2 Wiring for RI/O STOP and CPU STOP/RUN signals

Figure 7-14 shows the wiring for the RI/O STOP and CPU STOP/RUN signals.

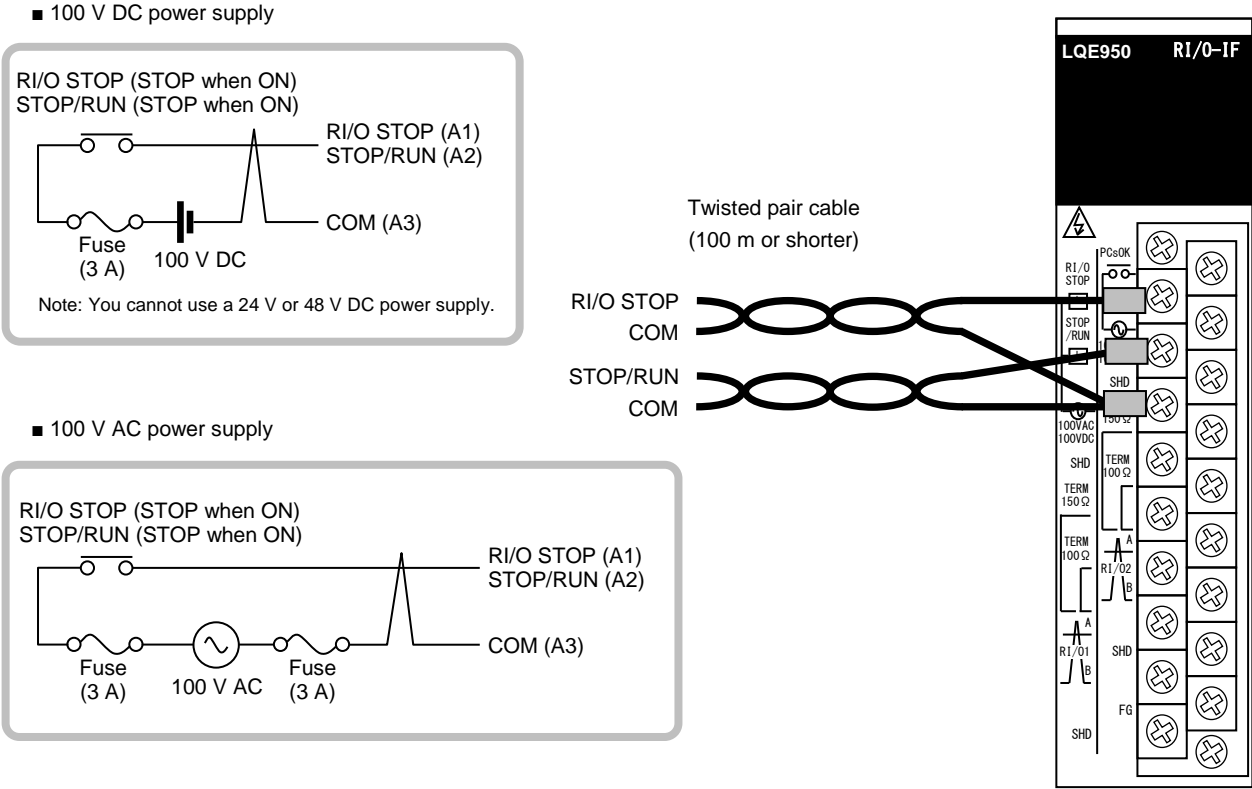

Figure 7-14 Wiring of RI/O STOP and CPU STOP/RUN signals

WARNING

- To avoid fire, place fuses on both sides of the AC power supply. This protects the system if the RI/O STOP (or STOP/RUN) or COM line shorts to FG.

7.7 Wiring for remote I/O

This section explains how to connect the remote I/O cables.

7.7.1 Connecting the remote I/O cables

- An RI/O-IF module is equipped with two remote I/O cable connection ports (RI/O-1 and RI/O-2). You can connect a maximum of 12 PI/O units to each port.
- The remote I/O cable connection ports (RI/O-1 and RI/O-2) of a PI/O unit are connected internally. Note that the port numbers of the CPU module have no relation to these port numbers. When connecting to the RI/O-1 port of the RI/O-IF module, use a station number in the range from 00 to 3F. When connecting to the RI/O-2 port, use a station number in the range from 40 to 7F.
- You must terminate the ends of the remote I/O line at the RI/O-IF module and remote I/O station module. As the terminating resistor, you can use the built-in 150Ω resistor, or an externally connected resistor with an arbitrary resistance value. Select the terminating resistance based on the characteristic impedance of the remote I/O cable. For details, see 7.7.4 *Setting terminating resistance*.
- Improper wiring can prevent communication. Take care to wire the remote I/O cables in the prescribed way. For details, see 7.7.2 *Examples of improper remote I/O wiring*.
- The shield of the remote I/O cable must be grounded at one end only on the RI/O-IF side. Although the shield can be grounded at both ends if the grounding points are the same, we recommend that you keep your wiring approach consistent by grounding the shield at one end only on the RI/O-IF module side.

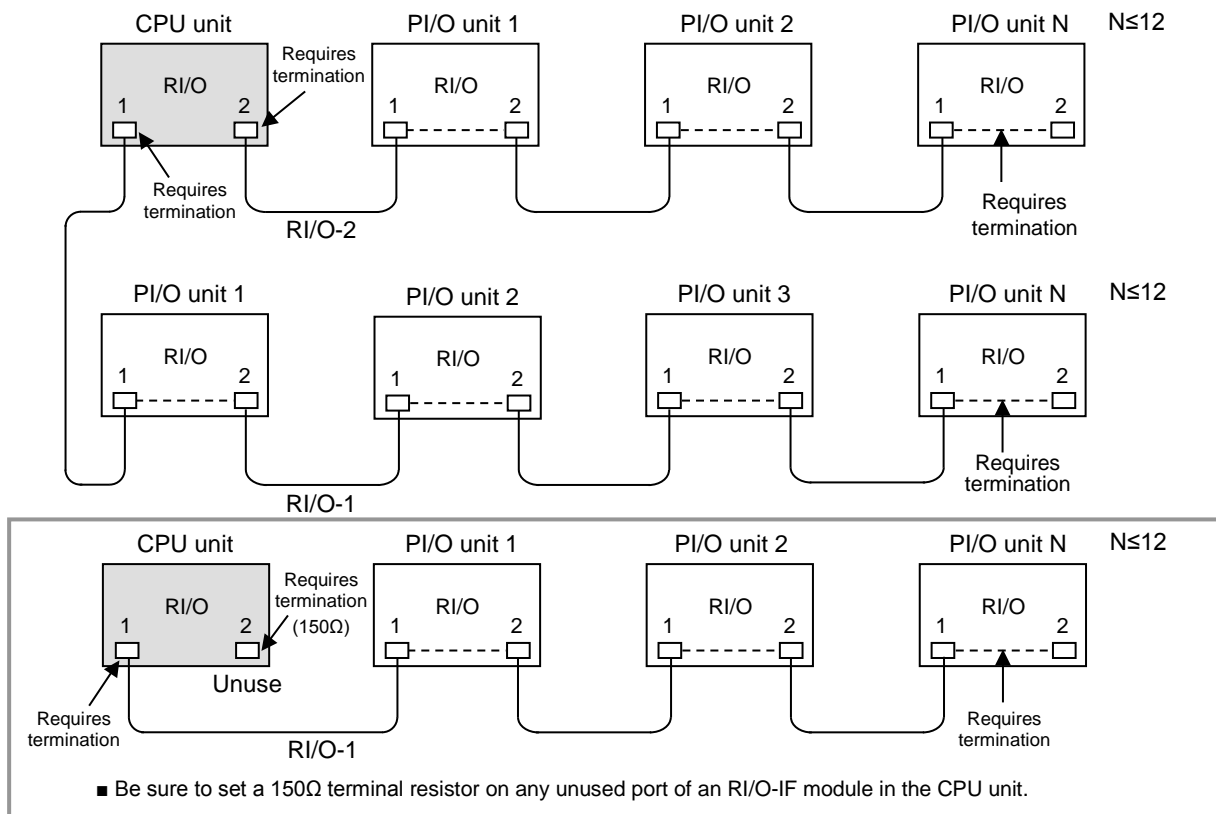

Figure 7-15 Wiring of remote I/O cables

Notice

- To avoid malfunction, set a terminating resistance (150Ω) at any RI/O-IF module ports to which a remote I/O cable will not be connected. This prevents external noise from entering the system.

7.7.2 Examples of improper remote I/O wiring

Wiring the remote I/O cables in any of the incorrect ways shown in Table 7-4 can distort the waveform of the signal on the lines, causing communication errors. Take care to wire the cables correctly.

Table 7-4 Correct and incorrect remote I/O wiring

Correct wiring	<p> <ul style="list-style-type: none"> ■ A maximum of 12 units can be connected per line, and you must terminate the line at both ends. ■ The unused port of the RI/O-IF module in the CPU unit must be terminated with 150Ω resistance. </p>
	<p> <ul style="list-style-type: none"> ■ There are no restrictions in terms of the positioning of the CPU unit. </p>
Examples of incorrect wiring	<p> <ul style="list-style-type: none"> ■ Do not use a branching connection. </p>
	<p> <ul style="list-style-type: none"> ■ Do not form a closed loop. </p>
	<p> <ul style="list-style-type: none"> ■ Connect cables directly, not via a terminal block. </p>
	<p> <ul style="list-style-type: none"> ■ Do not mix cable types in a given line. </p>

Notice

- To avoid malfunction, set a terminating resistance (150Ω) at any RI/O-IF module ports to which a remote I/O cable will not be connected. This prevents external noise from entering the system.

7.7.3 Examples of cable wiring

- (1) When connecting cables with different characteristics to the RI/O-1 and RI/O-2 ports

Figure 7-16 shows a wiring example for a scenario in which cables with different characteristics connect to the RI/O-1 port and RI/O-2 port of the CPU module.

- For details on how to set the terminating resistance, see 7.7.4 *Setting terminating resistance*.

- For details on ground wiring, see 7.4 *Ground wiring*.

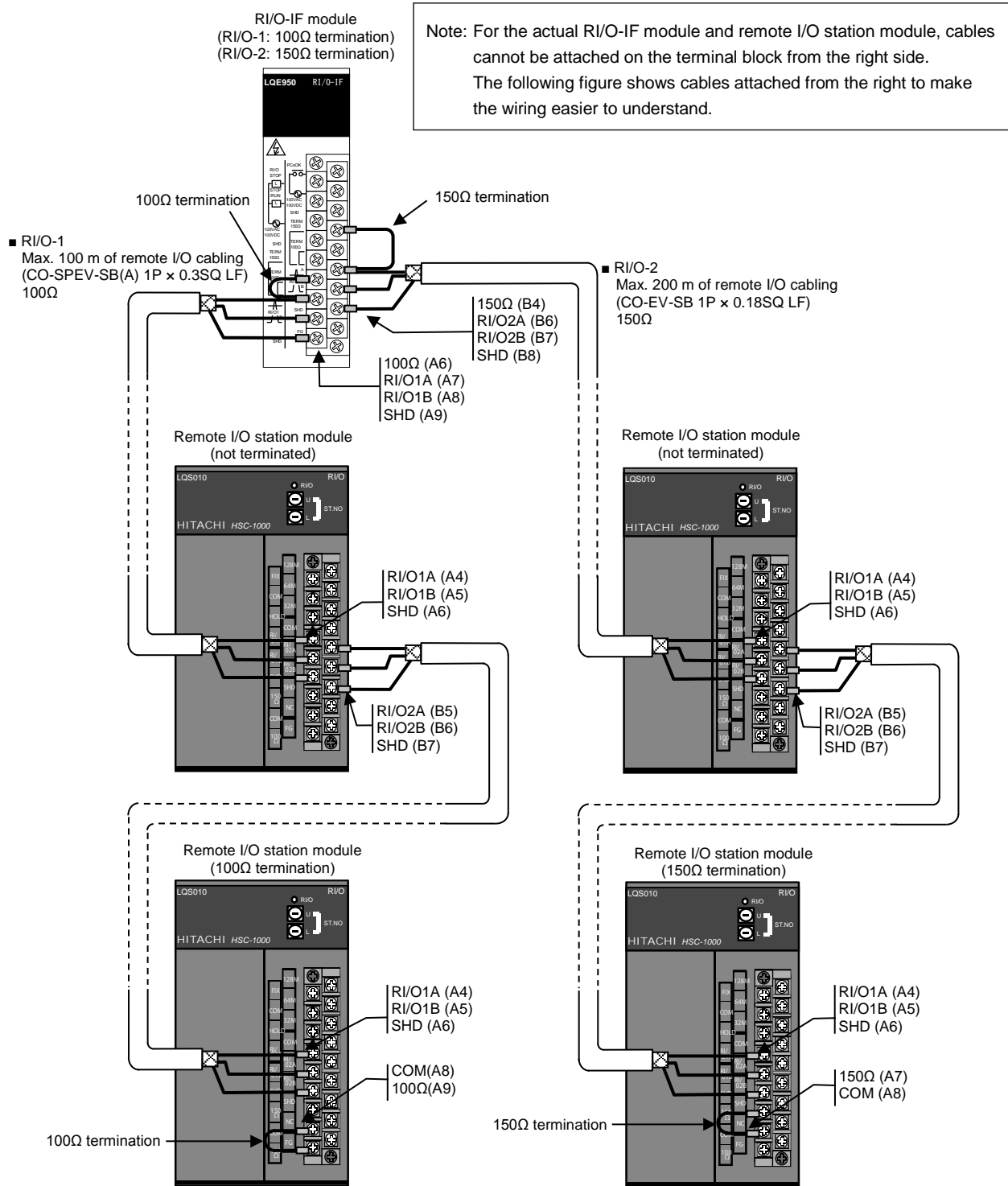

Figure 7-16 Wiring example when using cables with different characteristics

- (2) When using the HSC-1000 series remote I/O station (RI/O: LQS010) together with the HSC-2100 series remote I/O station (E.STATION: LWS410)

Like the S10V, the S10VE can connect to HSC-1000 series and HSC-2100 series remote I/O stations. The S10VE can also connect to the remote I/O stations designed for common use by the S10V and S10mini. Figure 7-17 shows a wiring example for these scenarios.

- For details on how to set the terminating resistance, see 7.7.4 *Setting terminating resistance*.
- For details on ground wiring, see 7.4 *Ground wiring*.

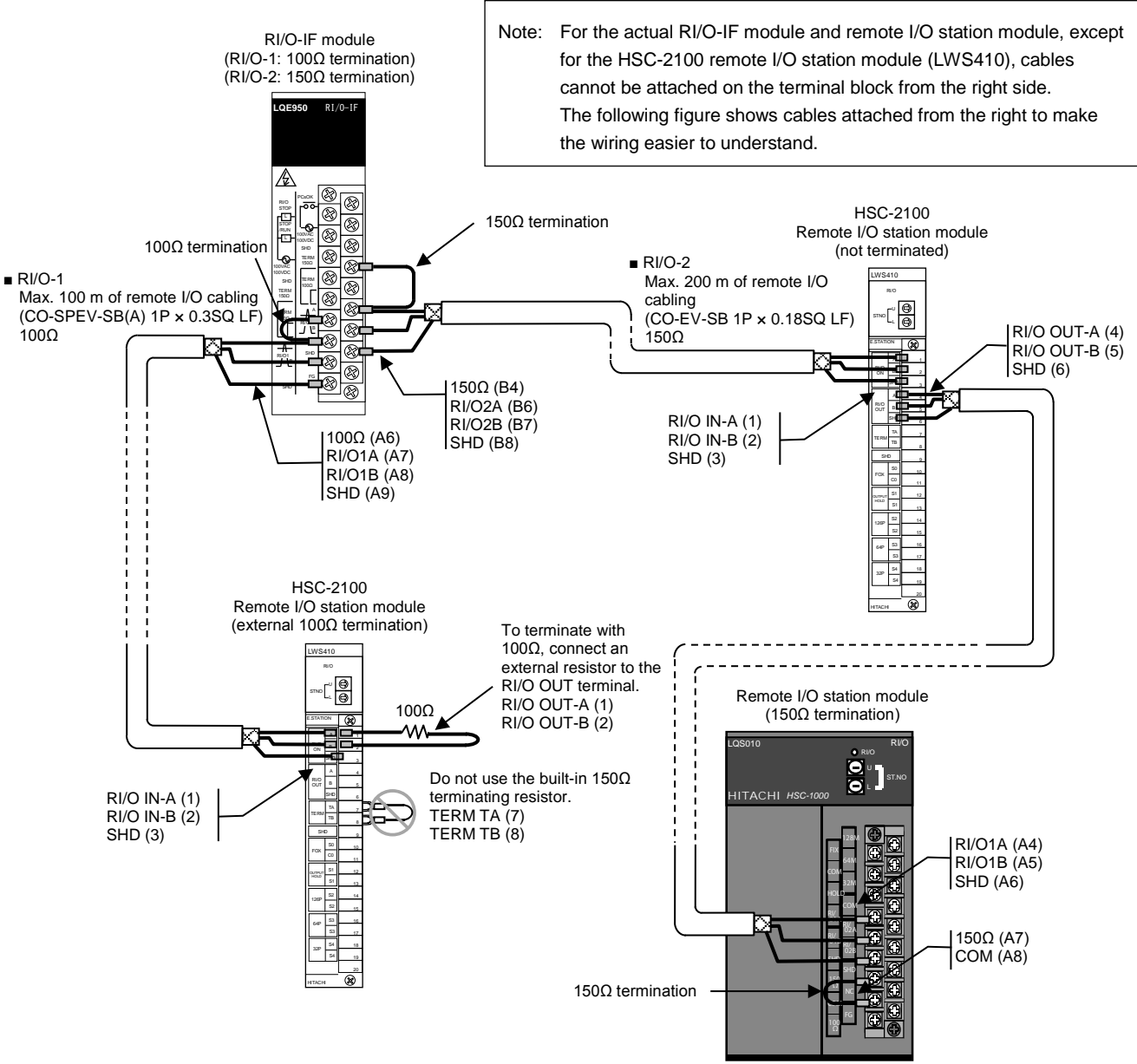

Figure 7-17 Wiring example when using HSC-1000 and HSC-2100 series remote I/O stations in the same system

7.7.4 Setting terminating resistance

When using the designated cables, connect the terminals as shown in Table 7-5. This will terminate the lines with a built-in 100Ω or 150Ω resistor (or an externally wired 100Ω resistor on the RI/O-IF module). To terminate with a resistance other than 100Ω or 150Ω using non-designated cables, connect a resistor across the signal input terminals (A and B).

Table 7-5 Setting terminating resistance

	100Ω termination	150Ω termination	Termination with arbitrary resistance
RI/O-IF module	<p>A: Wire together with signal cable</p>	<p>A: Wire together with signal cable Note 1: Set a 150Ω terminating resistance at ports to which no remote I/O cables are connected.</p>	<p>R: Characteristic impedance of remote I/O cable A and B: Wire together with signal cable</p>
Remote I/O station module			<p>R: Characteristic impedance of remote I/O cable A and B: Wire together with signal cable</p>

- Recommended specification of terminating resistor (R):
 - Type: Metal oxide film resistor
 - Resistance value: Same as cable impedance
 - Tolerance: ±10%
 - Power rating: 0.5 W (1/2 W)
 - Shape: Axial

Note 2: For the actual RI/O-IF module, cables cannot be attached on the terminal block from the right side. The preceding figures show cables attached from the right to make the wiring easier to understand.

 **WARNING**

- To avoid electric shock, do not touch the terminal block terminals or connector pins while the power is on.
- To avoid electric shock and fire, wiring must be carried out by a person with practical experience who has undergone the appropriate training and is able to recognize the hazards presented by the work.
- To avoid electric shock, accident, or malfunction, make sure that the power switch of the power supply module is off before connecting or disconnecting any cables. Re-attach the terminal cover as soon as you have completed the wiring.
- To avoid electric shock and fire, check the wiring carefully before turning on the power.

Notice

- Noise can cause malfunction. Do not harness the wiring for 100 V AC or 100 V DC power together with network cables. There must be at least 100 mm separation between the two types of cabling.
- To protect from short circuits, provide fuses or circuit protectors in any external power source. Use a circuit protector that is appropriate for the rating of the system.
- Surge voltage can cause equipment damage or malfunction. If you connect a coil (such as a relay) to the PCsOK output circuit, you must also provide a surge absorption diode or other means to protect from surge voltage. This diode must withstand reverse voltage of at least 10 times the circuit voltage, and a forward current matching or exceeding the load current.
- Noise can cause the equipment to malfunction. Keep each type of cable, such as communication cables, power cables, and lead cables separated when wiring the system. It is of particular importance that lead cables such as those for inverters, motors, and power regulators are separated from other cables by at least 300 mm. Furthermore, communication cables must travel through different conduits and ducts from lead cables.
- Static electricity might damage a module or cause it to malfunction. Discharge any static electricity from your body before touching the equipment.
- To avoid malfunction, set a terminating resistance (150Ω) at any RI/O-IF module ports to which a remote I/O cable will not be connected. This prevents external noise from entering the system.

7.7.5 Connecting the remote I/O cable shields

This section explains how to connect the shields of the remote I/O cables that connect to RI/O-IF modules.

■ Connecting the shields of remote I/O cables

Connect the shields of the cables connected to remote I/O ports 1 and 2 to the respective SHD terminals on the terminal block. The SHD terminals of remote I/O lines 1 and 2 have internal connections to the FG terminals, and thus no external wiring is required between SHD and FG. Connect the FG terminal to the FG terminal of the power supply module and the FG terminal of the mount base by using daisy-chain wiring.

■ Connecting cable shield leads for CPU status I/O cables

Connect the shield leads for the CPU state I/O cables to the respective SHD terminals on the terminal block. The SHD terminals of CPU state I/O have internal connections to the FG terminals, and thus no external wiring is required between SHD and FG. Connect the FG terminal to the FG terminal of the power supply module and the FG terminal of the mount base by using daisy-chain wiring.

(1) Examples of connections in the same panel and between panels installed in a row

When connecting remote I/O cables in the same panel or in panels installed in a row, ground the shield of the remote I/O cable at one end on the RI/O-IF module side. Although the shield can be grounded at both ends if the grounding points are the same, we recommend that you keep your wiring approach consistent by grounding the shield at one end only on the RI/O-IF module side.

● Grounding the shield at one end

Connect the FG terminal of the RI/O-IF module to the FG terminal of the power supply module and the FG terminal of the mount base. Do not connect anything to the FG terminal of the remote I/O station module.

● Grounding the shield at both ends

Connect the FG terminal of the RI/O-IF module to the FG terminal of the power supply module and the FG terminal of the mount base. Connect the FG terminal of the remote I/O station module to the FG terminal of the I/O mount base.

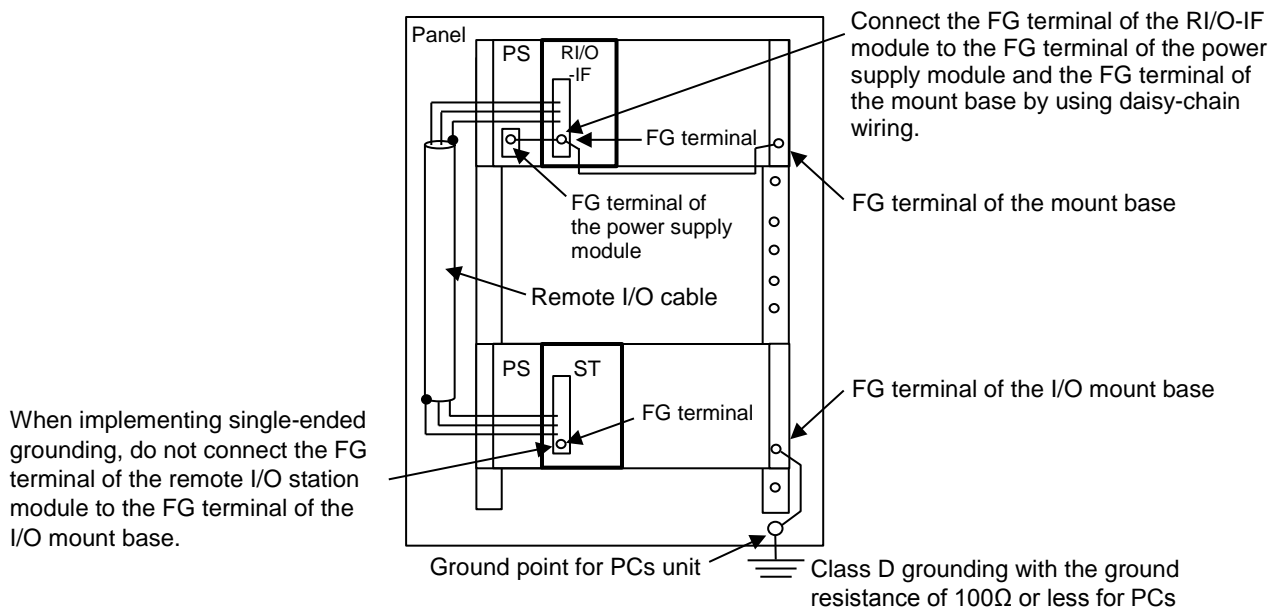

ST: Remote I/O station module, PS: Power supply module

Figure 7-18 Example of connections within the same panel

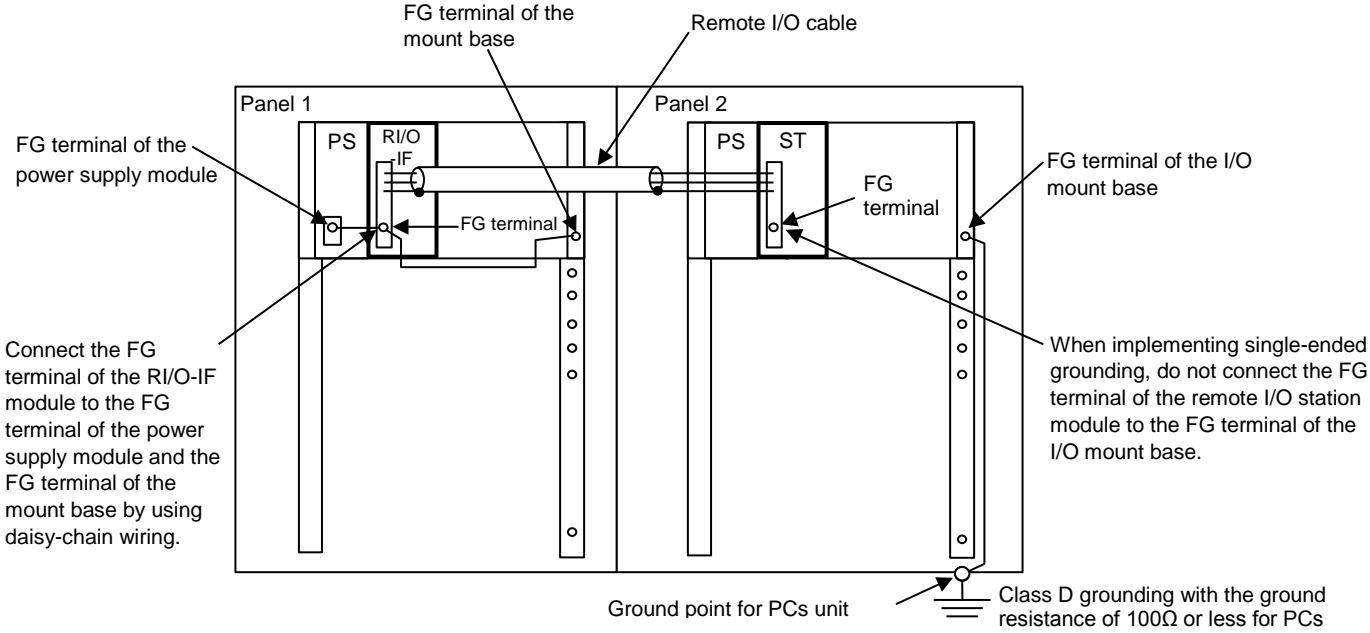

Figure 7-19 Examples of connections between panels installed in a row

7. Wiring

(2) Example of connections between different panels

When connecting the remote I/O cable between different panels, ground the shield of the remote I/O cable at one end on the RI/O-IF module side.

Connect the FG terminal of the RI/O-IF module to the FG terminal of the power supply module and the FG terminal of the mount base. Do not connect anything to the FG terminal of the remote I/O station module.

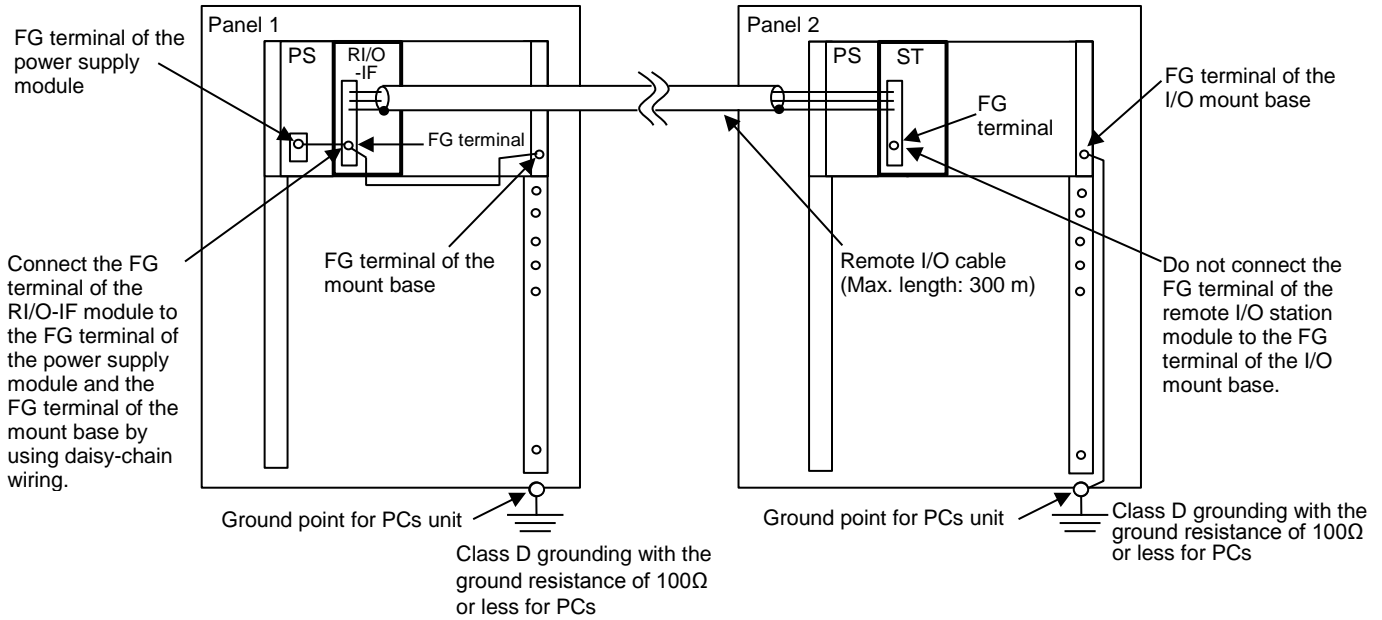

Figure 7-20 Example of connections between different panels

(3) Examples of connections in the same panel and between different panels

When connecting remote I/O cables within the same panel and between different panels, ground the shield of the remote I/O cables at one end on the RI/O-IF module side. Connect the FG terminal of the RI/O-IF module to the FG terminal of the power supply module and the FG terminal of the mount base. Do not connect anything to the FG terminal of the remote I/O station module.

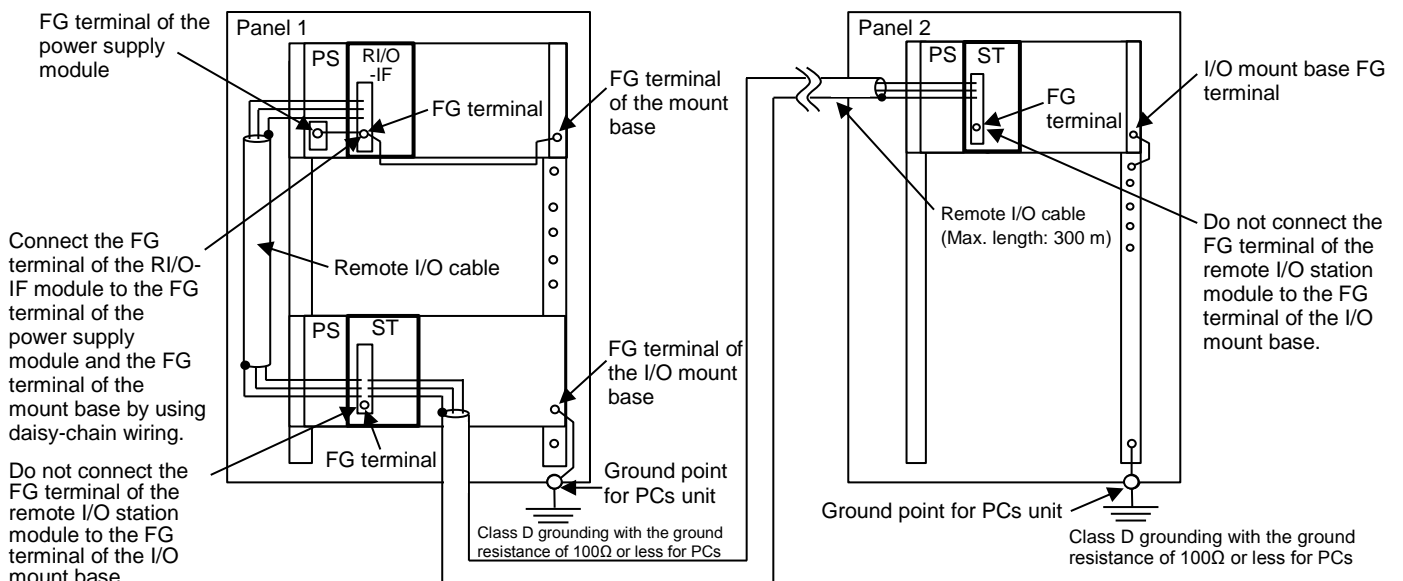

Figure 7-21 Example of connections in the same panel and between different panels

7.8 Wiring the Ethernet cabling

When using only one channel for Ethernet communication in the CPU module, connect the Ethernet cable to the ET1 connector of the CPU module.

This is to allow the PADT to connect to the ET2 connector during maintenance.

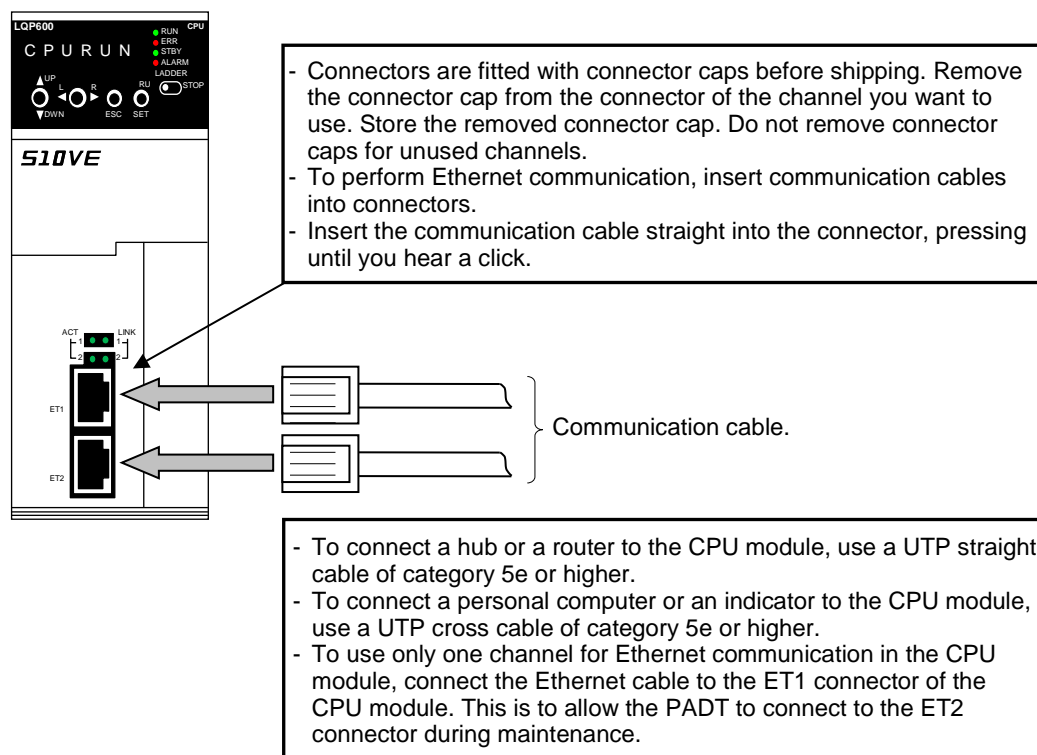

Figure 7-22 Wiring the Ethernet cabling

7.9 Circuit classifications and examples of duct wiring

7.9.1 Circuit classifications for wiring

Table 7-6 Circuit classifications

Symbol	Classification	Description	Example
HC	General control circuit	Control circuit and input power supply circuit for 250 V or lower	- Power supply module wiring - Digital I/O wiring for 100 V AC - Wiring for PCsOK signal, CPU STOP/RUN signal, and RI/O STOP signal of RI/O-IF module
LC	Low-voltage control circuit	Small relay circuit for 60 V DC or lower	Digital I/O wiring for 48 V or 24 V DC
LT	Low-level signal circuit	Circuit that uses ICs and other elements for 24 V DC or lower signals	Analog I/O wiring
LS	Special signal circuit	Low noise-resistance circuit such as those for high-speed digital signals (Example: High-speed bus line cable)	- Ethernet wiring - Remote I/O wiring

7. Wiring

7.9.2 Example of duct wiring

Figure 7-23 shows an example of ducting in a cabinet in which each duct carries cables for a different circuit classification.

- Provide as much distance as possible between ducts for different circuit classifications.
- Where the ducts for different circuit classifications cross, have them cross at right angles.
- Avoid having HC or LC wiring run in parallel with LT or LS wiring.

If doing so is unavoidable, leave clearance of at least 200 mm between them.

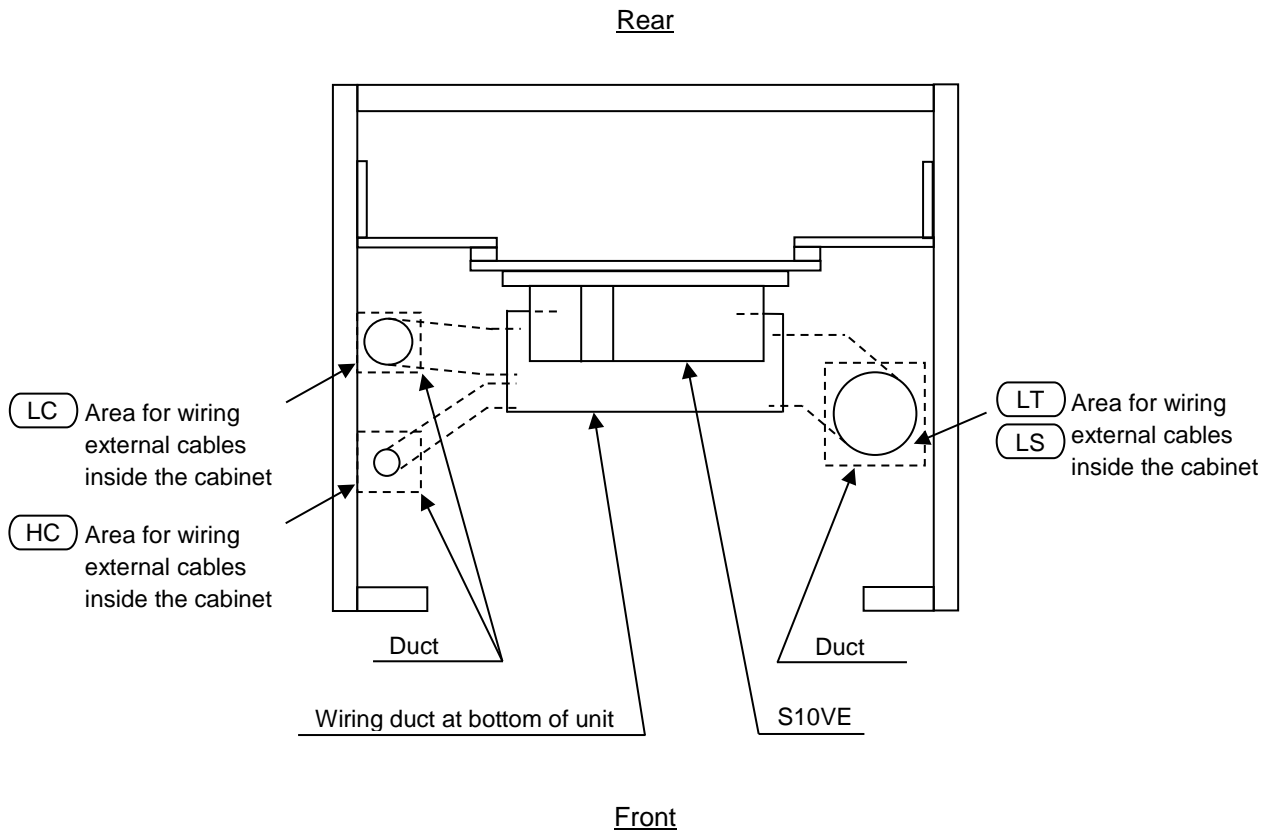

Figure 7-23 Example of wiring ducts carrying cables for different circuit classifications (top view)

7.10 Working with connector caps

Each connector is fitted with a connector cap before shipping. Remove the cap before wiring the connector. The removed connector cap must be stored. Leave the caps on connectors that will not be used. Figures 7-24 and 7-25 show where connector caps are fitted to the product during shipping.

(1) CPU module

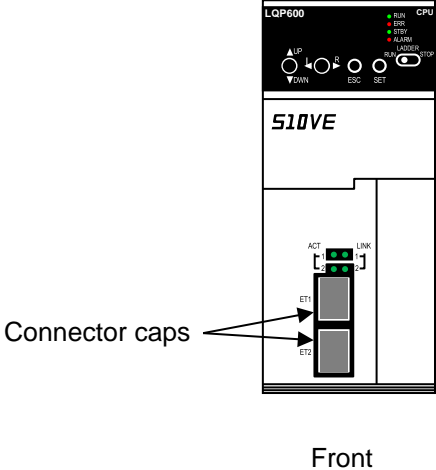

Figure 7-24 Positions of connector caps on CPU module during shipping

(2) 7-slot mount base (HSC-1770)

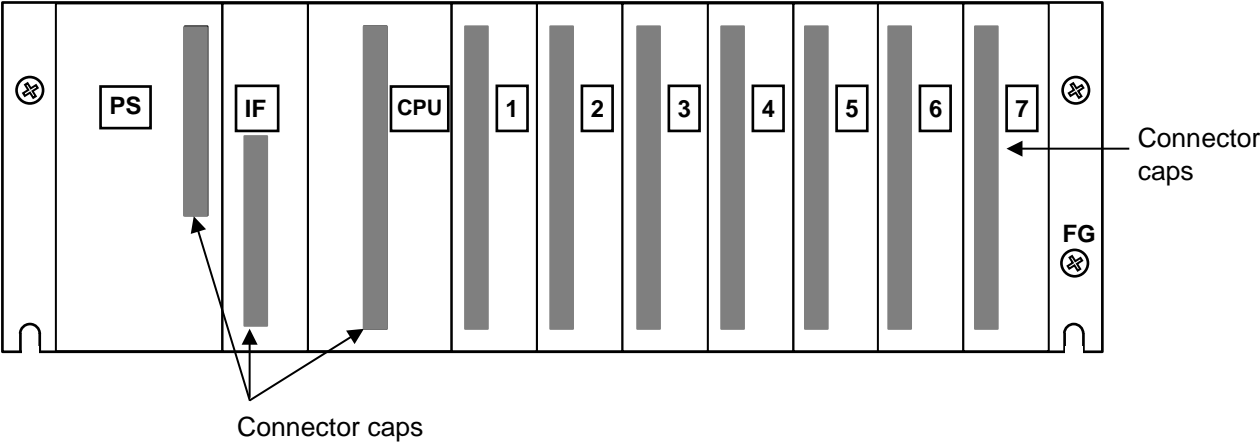

Figure 7-25 Positions of connector caps on mount base during shipping

This page is intentionally left blank.

8. Tools

8.1 Notes on tool usage

8.1.1 Overview of tools

BASE SYSTEM/S10VE (hereafter *BASE SYSTEM*) is a tool used to view, monitor, and debug the system configuration, settings, and RAS information of the S10VE. It follows the same conventions as any other Windows®-based application.

Table 8-1 Types of tool

Package name	Model	Manner of provision
BASE SYSTEM/S10VE	S-7898-38	Sold separately

8.1.2 Hardware and software requirements

BASE SYSTEM requires the following operating environment:

- Personal computer (hereafter the PADT) with a CPU of 1 GHz or faster
- Display with a resolution of 1,366 × 768 dots or higher (FWXGA)
- 2 GB (or more) RAM
- Free hard disk capacity of 200 MB or more
- S10VE series CPU module, power supply module, mount base, and RI/O-IF module
- Cable for connecting the PADT and PCs (LAN cable)
- Remote I/O station, power supply, mount base, cards, and wiring cables, as needed
- Microsoft® Windows® 7 (64-bit) operating system or Microsoft® Windows® 10 (64-bit) operating system
- Microsoft .NET Framework 4
- Microsoft Visual C++ 2010 redistributable package (x64)

Users of this product must have a basic knowledge of the Windows® environment and user interfaces. This system complies with the Windows® standard. This manual is intended for users who have mastered a basic knowledge of how to use Windows®.

8.1.3 Restrictions on connection configuration of PADT and S10VE

The following restrictions apply when connecting the PADT and the S10VE by means other than a direct Ethernet LAN cable connection:

Connection via a hub

Use a switch. If you use a hub, response times might become extremely slow while monitoring on the PADT, giving the appearance that on-screen operations have frozen.

8.2 Constructing the system

8.2.1 Constructing a new system

The following explains the procedure for creating a new project and setting up a new S10VE system.

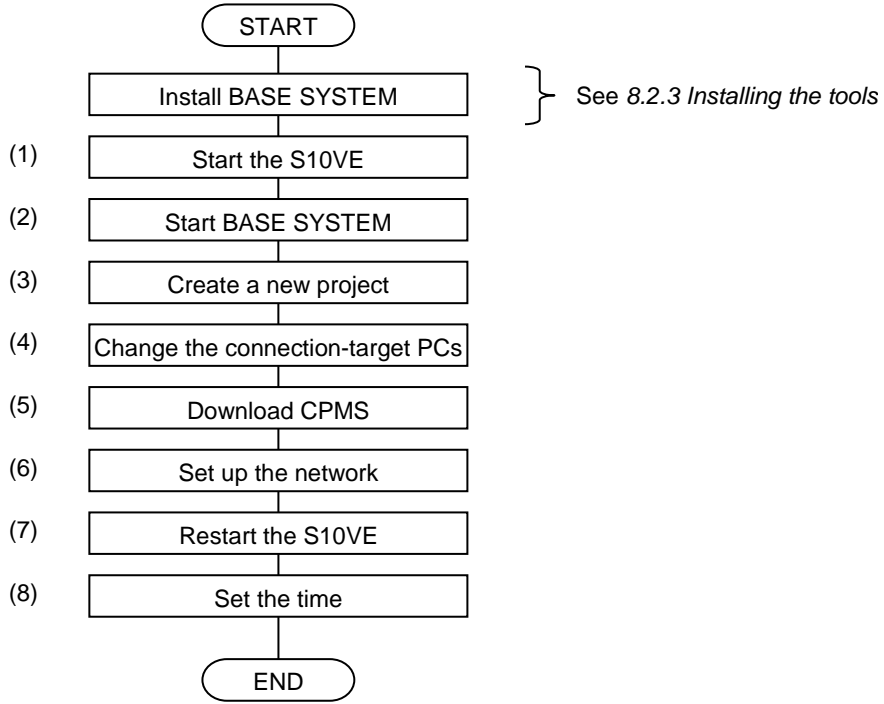

(1) Start the S10VE

Set the switches on the CPU module according to the following table, and then turn on the power switch on the power supply module of the S10VE.

Switch name	Setting
CPU RUN/STOP	RUN
LADDER RUN/STOP	STOP
ET ST.No.	0xFF

(2) Start BASE SYSTEM

Start BASE SYSTEM by following the procedure in 8.3.1.1 *Starting BASE SYSTEM*.

(3) Create a project

From the BASE SYSTEM main menu, select **Project** and then **New**. The Properties window appears. Create a new project by following the procedure in 8.4.2.1 *Project menu: New*.

(4) Change the connection-destination PCs

From the BASE SYSTEM main menu, select **Online** and then **Change PCs**. The Change PCs window appears. By following the procedure in 8.4.3.1 *Online menu: Change PCs*, set the station number to 0xFF and the IP address to 192.192.192.1.

(5) Download CPMS

From the BASE SYSTEM main menu, select **Project** and then **Download CPMS**. The Download CPMS window appears. Download CPMS to the S10VE by following the procedure in 8.4.2.6 *Project menu: Download CPMS*.

(6) Set up the network

From the BASE SYSTEM main menu, select **Project, Set Network**, and then **Ethernet**. The Set Network window appears. Set the network information by following the procedure in 8.4.2.5 *Network configuration*.

(7) Restarting the S10VE

Turn off the power switch of the power supply module of the S10VE, set the switches on the CPU module according to the following table, and then turn on the power supply module again.

Switch name	Setting
CPU RUN/STOP	RUN
LADDER RUN/STOP	STOP → RUN
ET ST.No.	0xFF →#

#: The station number specified in (6) *Set up the network*.

(8) Changing the connection-destination PCs

From the BASE SYSTEM main menu, select **Online** and then **Change PCs**. The Change PCs window appears. By following the procedure in 8.4.3.1 *Online menu: Change PCs*, set the station number and IP address to the network information you specified in (6) *Set up the network*.

(9) Set the time

From the BASE SYSTEM main menu, select **Setting** and then **Set Time**. The Set Time window appears. Set the time by following the procedure in 8.4.5.1 *Setting menu: Set Time*.

Having completed these steps, you can then perform other tasks as required such as uploading ladder logic and HI-FLOW programs and setting up option modules.

8.2.2 Replacing the CPMS

The following explains how to open an existing project and replace the CPMS of the S10VE.

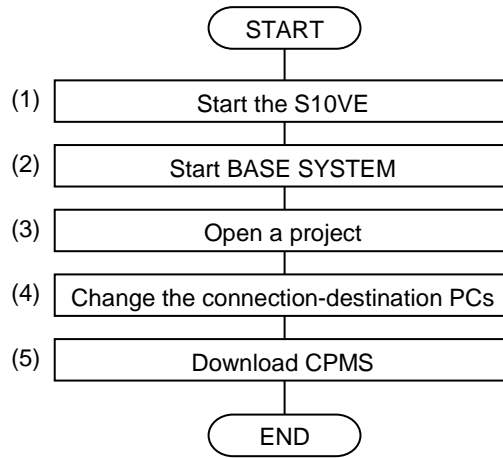

- (1) Start the S10VE
Turn on the power switch on the power supply module of the S10VE.
- (2) Start BASE SYSTEM.
Start BASE SYSTEM by following the procedure in *8.3.1.1 Starting BASE SYSTEM*.
- (3) Open a project
From the BASE SYSTEM main menu, select **Project** and then **Open**. The Project List window appears. Open a project by following the procedure in *8.4.2.2 Project menu: Open*.
Replace the CPMS of the project file by clicking the **CPMS Update** button in the Properties window that appears when you open the project.
- (4) Change the connection-destination PCs
If the connection type is set to ET .NET, change it to CPU built-in Ethernet. To make this change, from the BASE SYSTEM main menu, select **Online** and then **Change PCs**. The Change PCs window appears. Change the connection type by following the procedure in *8.4.3.1 Online menu: Change PCs*.
- (5) Download the CPMS
From the BASE SYSTEM main menu, select **Project** and then **Download CPMS**. The Download CPMS window appears. Download the CPMS to the S10VE by following the procedure in *8.4.2.6 Project menu: Download CPMS*.

8.2.3 Installing the tools

This section explains how to install various software on the PADT.

8.2.3.1 Notes on installation

The various tools associated with programming and operation of the S10VE software (ladder diagram, HI-FLOW, RPDP, and NXACP) are compatible with the Microsoft® Windows® 7 (64-bit) and Microsoft® Windows® 10 (64-bit) operating systems. Note that the following runtime libraries must be installed for the S10VE tools to work. If these runtime libraries are not installed, install them from the Microsoft Download Center before you start using the tools.

- Microsoft .NET Framework 4
- Microsoft Visual C++ 2010 Redistributable Package (x64)

- Do not attempt to start the BASE SYSTEM/S10VE tool in an environment without Microsoft .NET Framework 4 installed. If you do so, the error message `.NET Framework Initialization Error` appears and the tool cannot start.
- Do not attempt to start the BASE SYSTEM/S10VE tool in an environment without the Microsoft Visual C++ 2010 Redistributable Package (x64) installed. If you do so, the error message `The program can't start because MSVCR110.dll is missing from your computer. Re-installing the application may fix this problem.` appears during startup, and BASE SET/S10VE terminates abnormally.

Notice

- Use an account with administrator privileges to install and uninstall the S10VE tools. If you use a standard account, the tools might not be installed or uninstalled correctly.
- Exit all Windows® programs before installing each tool. This includes memory-resident programs such as anti-virus software. An error might occur if you attempt to install a tool with other programs still running. In this case, uninstall the tool you were installing and exit all Windows® programs. Then, install the tool again. For details on how to uninstall a tool, see *8.2.3.3 Uninstalling individual tools*.
- Do not install an S10VE tool to any of the following folders, which are protected by User Account Control:
 - Program file folder (for example, `C:\Program Files`)
 - System root folder (for example, `C:\Windows`)
 - System drive root folder (for example, `C:\`)
 - Program data folder (for example, `C:\ProgramData`)

8.2.3.2 Installing individual tools

You can install tools from a CD or from the basic installation set. The following explains how to install tools from the HI-FLOW SYSTEM/S10VE installation CD.

Log on as an account with administrator privileges when installing the tools.

- (1) To install the HI-FLOW SYSTEM/S10VE tool, double-click `setup.exe` in the folder `S789803` on the HI-FLOW SYSTEM/S10VE installation CD. The `setup.exe` file of each tool is located in a different folder.
- (2) When you double-click `setup.exe`, the following message might appear. Click **Yes** to acknowledge the message and begin the setup process.

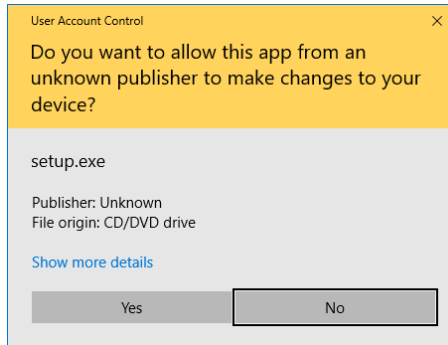

Figure 8-1 User Account Control message

- (3) The InstallShield Wizard window appears. Install the tool as prompted by the messages in the installer.

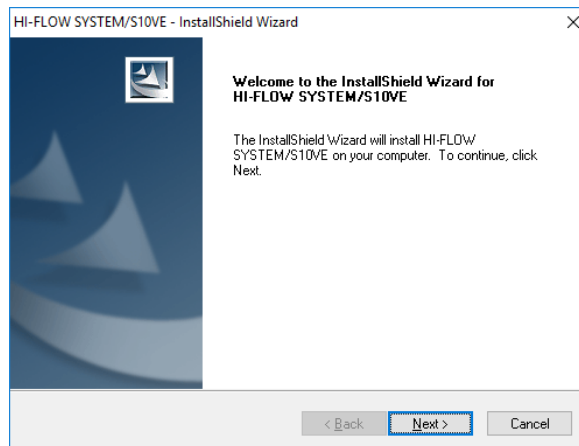

Figure 8-2 InstallShield Wizard window

- (4) When the installation process has completed, the InstallShield Wizard Complete window appears. Click **Finish**.

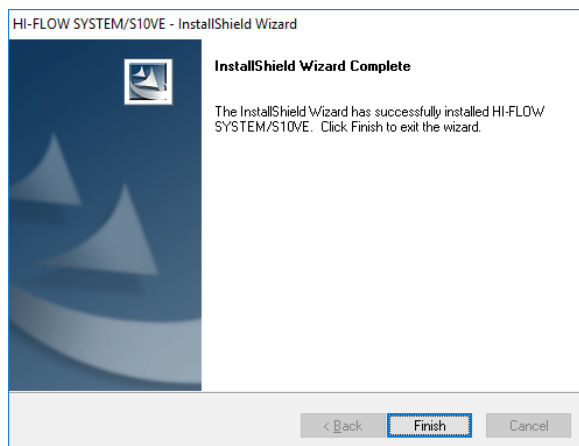

Figure 8-3 InstallShield Wizard Complete window

Notice

- BASE SYSTEM/S10VE cannot be installed on a per-user basis. To install BASE SYSTEM/S10VE successfully, you must first log on to the system with an administrator account. BASE SYSTEM/S10VE might not be installed properly in any of the following cases: 1) Administrator permissions are acquired by using User Account Control[#] from a standard user account, 2) The administrator account was created from a standard user account by using User Account Control. In this case, log on with the administrator account that was first created on your PADT, and then reinstall BASE SYSTEM/S10VE. If you log on with a user account other than that used for installing BASE SYSTEM/S10VE, the installed program might not appear in the program menu. In this case, log off and log on again with the administrator account that was first created on your PADT, uninstall the installed program, and then install the program again. When you want to create a new account, log on with an administrator account without using User Account Control.
- [#]: User Account Control is a Microsoft Windows feature that temporarily grants administrative rights to standard user accounts.

8.2.3.3 Uninstalling individual tools

You can uninstall tools from the Control Panel or from the basic installation set. The following procedure uses the example of uninstalling BASE SYSTEM/S10VE from the Control Panel.

Log on as an account with administrator privileges when uninstalling tools.

- (1) From the **Start** menu, open the Control Panel. Click **Uninstall a program**, and then double-click **BASE SYSTEM/S10VE**.
- (2) The message Are you sure you want to uninstall the selected application and all of its components? appears. Click **Yes** to uninstall the tool. To cancel uninstallation of the tool, click **No**.

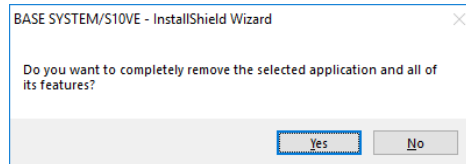

Figure 8-4 "Are you sure you want to uninstall the selected application and all of its components?" message

- (3) When uninstallation is complete, the message Uninstall Complete appears. Click **Finish**.

- If a Remove Shared File? window appears during uninstallation, click **No**. This leaves the shared file in place.
- If you uninstall a tool while that tool is running, a dialog box appears as shown in Figure 8-6 asking whether you want to restart your computer. Restart the computer as directed. This process will remove any files that were in use.

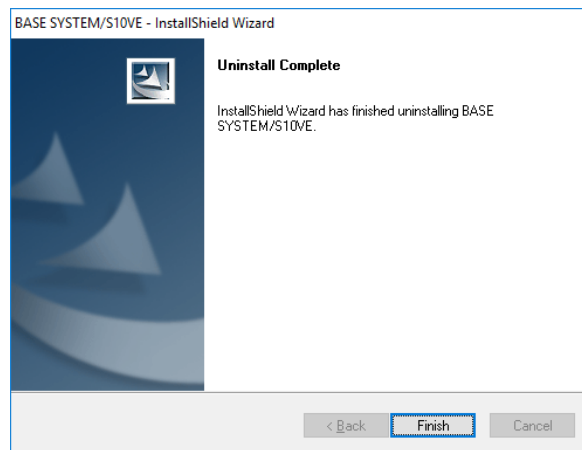

Figure 8-5 Uninstall Complete message (for uninstallation with tool not running)

If you uninstall a tool without shutting it down first, the Uninstall Complete message shown in Figure 8-6 appears instead of that shown in Figure 8-5. Select whether you want to restart the computer now or later, and then click **Finish**.

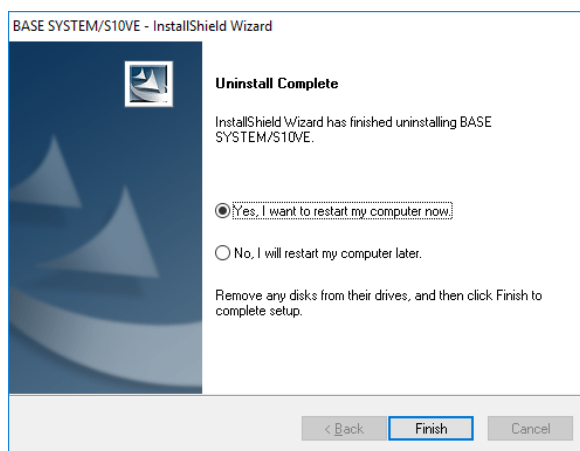

Figure 8-6 Uninstall Complete message (for uninstallation of running tool)

If you restart a computer on which RPDP is installed, an RPDP internal command displays the error message shown in Figure 8-7. Click **OK** to dismiss the error message. This message will not appear when you restart the computer after installing BASE SYSTEM.

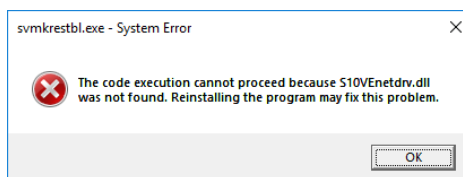

Figure 8-7 Error message displayed by RPDP internal command

Uninstallation of RPDP is not supported. Only uninstall RPDP if you intend to re-install it.

8. Tools

8.2.3.4 Reinstalling individual tools

To reinstall a tool, you must first uninstall it. You can then install it again. For details on how to uninstall a tool, see [8.2.3.3 *Uninstalling individual tools*](#). For details on how to install a tool, see [8.2.3.2 *Installing individual tools*](#).

8.2.3.5 Installing and uninstalling tools from the basic installation set

This section explains how to install and uninstall individual tools from the basic installation set.

Review the notes in 8.2.3.1 *Notes on installation* before installing or uninstalling a tool. To install or uninstall a tool, you must log on as an account with administrator privileges.

- (1) To install or uninstall a tool from the basic installation set, double-click the `SETUP.exe` file on the CD (BASE SET/S10VE).
- (2) When you double-click `SETUP.exe`, the following message might appear. Click **Yes** to acknowledge the message and begin the setup process.

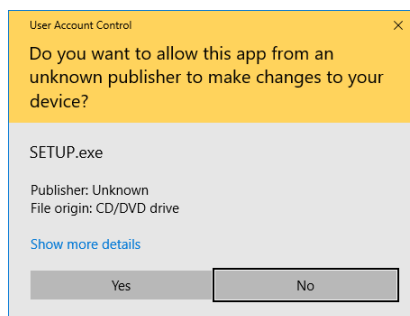

Figure 8-8 User Account Control message (basic installation set)

- (3) The Setup window appears.

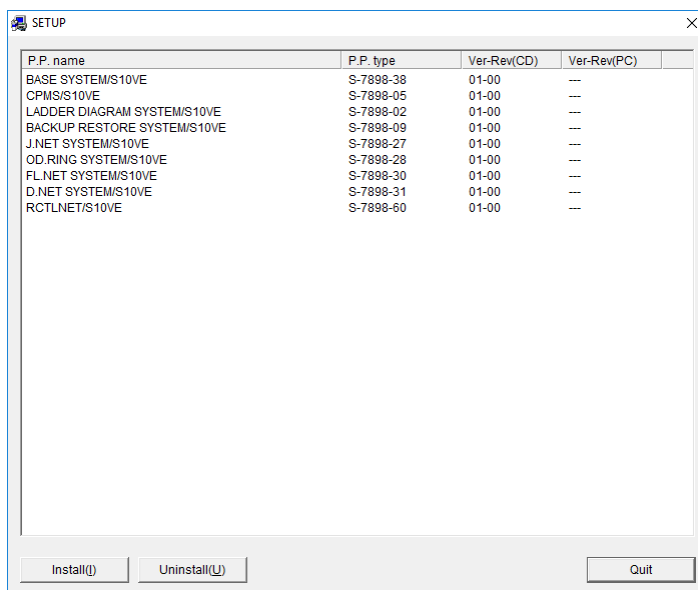

Figure 8-9 Setup window (basic installation set)

8. Tools

- (4) The list of tools contains the following information:

No.	Title	Description
1	P.P. name	The name of the tool.
2	P.P. type	The type of the tool.
3	Ver-Rev(CD)	The version and revision number of the tool to be installed from the CD.
4	Ver-Rev(PC)	The version and revision number of the tool that is installed on the PC. If the tool is not installed on the PC, --- is displayed.

- (5) When you click the **Install** button, installation of the tool selected in the list begins. Carry out the installation process by referring to step (3) onward in 8.2.3.2 *Installing individual tools*, and to the documentation for the tool you are installing.
You will be returned to the Setup window when the installation process has completed. Repeat this step until all tools have been installed.
- (6) When you click the **Uninstall** button, uninstallation of the tool selected in the list begins. Carry out the installation process by referring to step (2) onward in 8.2.3.3 *Uninstalling individual tools*, and to the documentation for the tool you are uninstalling.
You will be returned to the Setup window when the uninstallation process has completed. Repeat this step until all tools have been uninstalled.
- (7) To reinstall a tool selected in the tool list, uninstall the tool according to step (6), and then install it again according to step (5).
- (8) Click the **Finish** button to close the Setup window.

- The tools provided by the basic installation set have BASE SYSTEM as a prerequisite for installation. Be sure to install BASE SYSTEM first.
- To use BASE SYSTEM, you must install CPMS on the PADT.
- Do not initiate installation or uninstallation of a tool that is already in the process of being installed or uninstalled. If you do, the message *Another instance of this setup has already been executed* appears.

8.3 Starting the system

8.3.1 Starting tools

The following explains how to start the tools installed on the PADT.

8.3.1.1 Starting BASE SYSTEM

To start the installed BASE SYSTEM, you use the Windows® **Start** menu.

Suppose you intend to create or delete a project that uses C mode (RPDP) or use the CPMS update function in a project. In this case, you need to log on as an administrator with RPDP installed and start BASE SYSTEM normally, or log on as a user who belongs to the `RPDPusers` group and use temporary administrator privileges to start BASE SYSTEM.

To open a project that uses C mode, you need to start BASE SYSTEM normally on a system with RPDP installed as the administrator or a user belonging to the `RPDPusers` group.

(1) Starting BASE SYSTEM normally

To start BASE SYSTEM in Windows® 7, from the **Start** menu, select **All Programs, Hitachi S10VE, BASE SYSTEM**, and then **S10VEBASE**.

In Windows® 10, from the **Start** menu, select **Hitachi S10VE** and then **S10VEBASE**.

BASE SYSTEM starts (Figure 8-10).

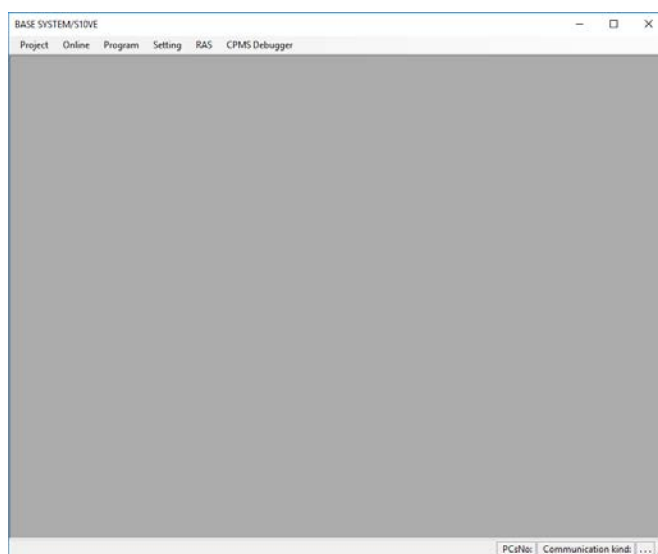

Figure 8-10 Screen displayed when BASE SYSTEM starts

8. Tools

- (2) Starting BASE SYSTEM using temporary administrator privileges

In Windows® 7, from the **Start** menu, select **Hitachi S10VE** and **BASE SYSTEM**, and then right-click **S10VEBASE**. From the right-click menu, select **Run as administrator**.

In Windows® 10, from the **Start** menu, select **Hitachi S10VE** and then right-click **S10VEBASE**.

From the right-click menu, select **Run as administrator**.

If a User Account Control dialog box appears, click **Yes**.

BASE SYSTEM starts (Figure 8-10).

- (3) Using BASE SYSTEM you started

First, create a new project or open an existing project. When you open a project, the features of BASE SYSTEM become available for use. For details about projects, see *8.4.2 Project functions*. To connect to PCs and use the functions of BASE SYSTEM, you must set a communication type. For details on how to set a communication type, see *8.4.3.1 Online menu: Change PCs*. The communication type you set remains in effect the next time you open the project.

Next, select the BASE SYSTEM function you want to use. For details, read starting from *8.4.2.5 Network configuration*.

8.3.1.2 Starting LADDER DIAGRAM SYSTEM

You start LADDER DIAGRAM SYSTEM from BASE SYSTEM.

For details on how to start LADDER DIAGRAM SYSTEM from BASE SYSTEM, see 8.4.4.1 *Program menu: LADDER*.

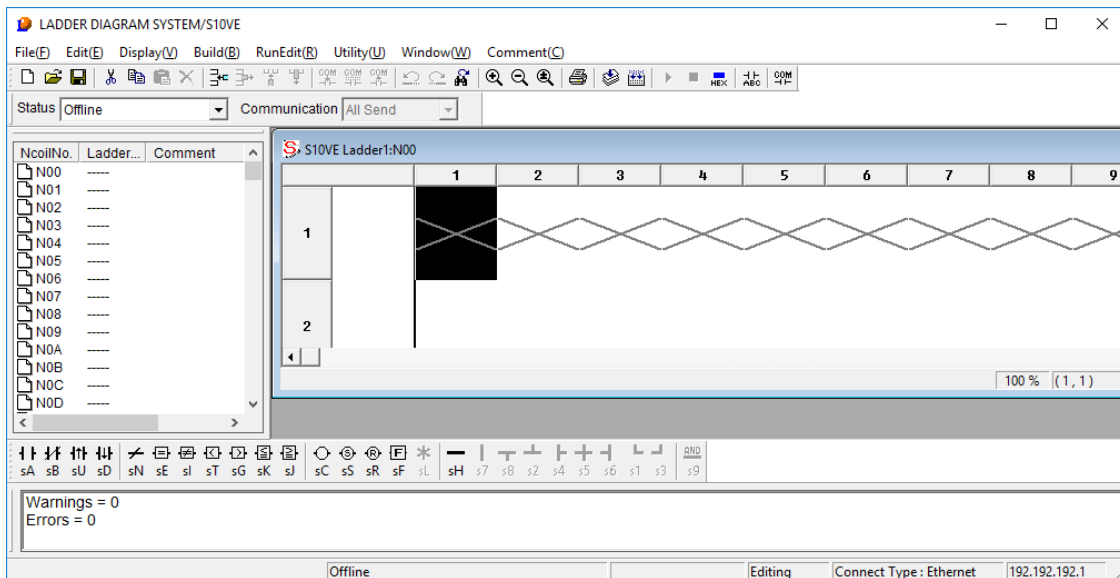

Figure 8-11 Screen displayed when LADDER DIAGRAM SYSTEM starts

For details on how to use LADDER DIAGRAM SYSTEM, see the *S10VE Software Manual Operation Ladder Diagram System for Windows®* (manual number SEE-3-131).

8. Tools

8.3.1.3 Starting HI-FLOW SYSTEM

You start HI-FLOW SYSTEM from BASE SYSTEM.

For details on how to start HI-FLOW SYSTEM from BASE SYSTEM, see 8.4.4.2 *Program menu: HI-FLOW*.

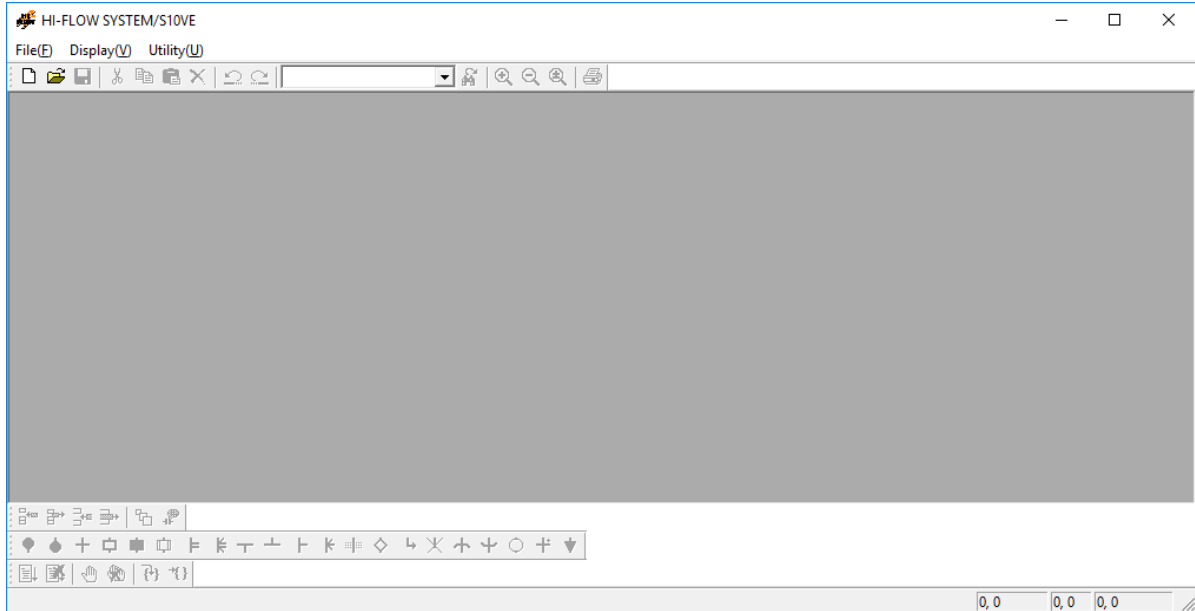

Figure 8-12 Screen displayed when HI-FLOW SYSTEM starts

For details on how to use HI-FLOW SYSTEM, see the *S10VE Software Manual Operation HI-FLOW for Windows®* (manual number SEE-3-132).

8.3.1.4 Starting the setup tools

The setup tools offer parameter setup functions for individual option modules. You can start each setup tool from BASE SYSTEM.

(1) Starting setup functions

From the BASE SYSTEM main menu, select **Program** and then **Setting Tool**. The Setting Tool window appears. Select the name of the system whose setup tool you want to start, and then click **Execute**. The main window for the selected setup tool appears. Use the setup tool to set up each module while referring to the documentation supplied with the option modules.

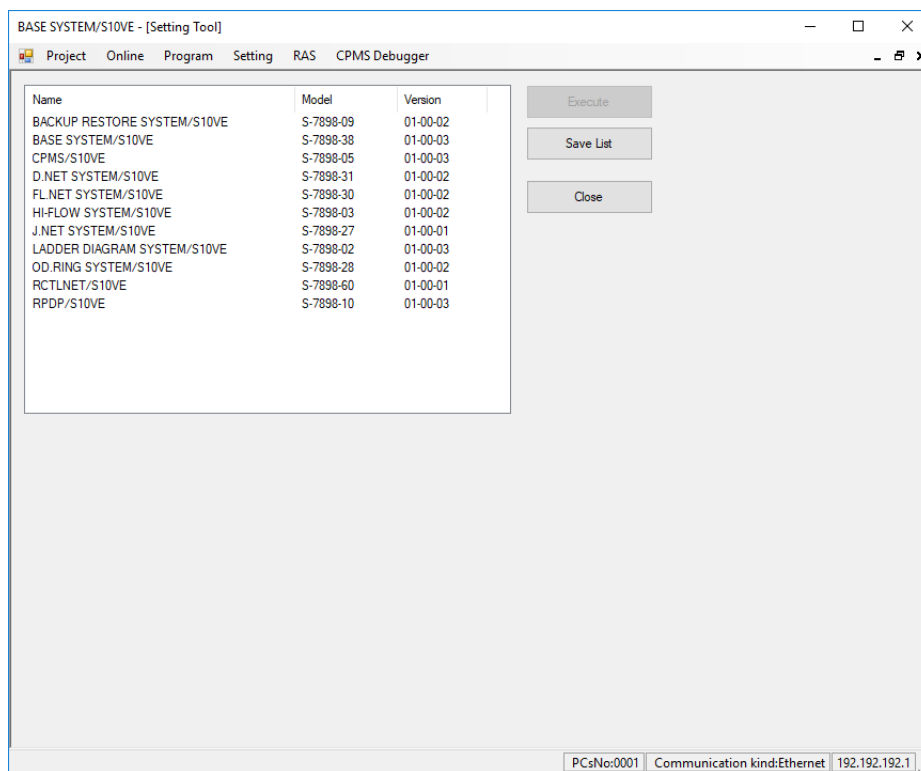

Figure 8-13 Setting Tool window

8. Tools

8.3.2 Exiting tools

The following explains how to exit each tool.

8.3.2.1 Exiting BASE SYSTEM

From the BASE SYSTEM main menu, select **Project** and then **End**.

8.3.2.2 Exiting the LADDER and HI-FLOW systems

From the LADDER DIAGRAM SYSTEM or HI-FLOW SYSTEM main menu, select **File** and then **End**.

8.3.2.3 Exiting setup tools

In the Setting main window of the setup tool, click **Close**.

8.4 BASE SYSTEM

8.4.1 Layout of the BASE SYSTEM main window

The following figure (Figure 8-14) shows the layout of the BASE SYSTEM main window.

This window consists of a main menu and a status bar.

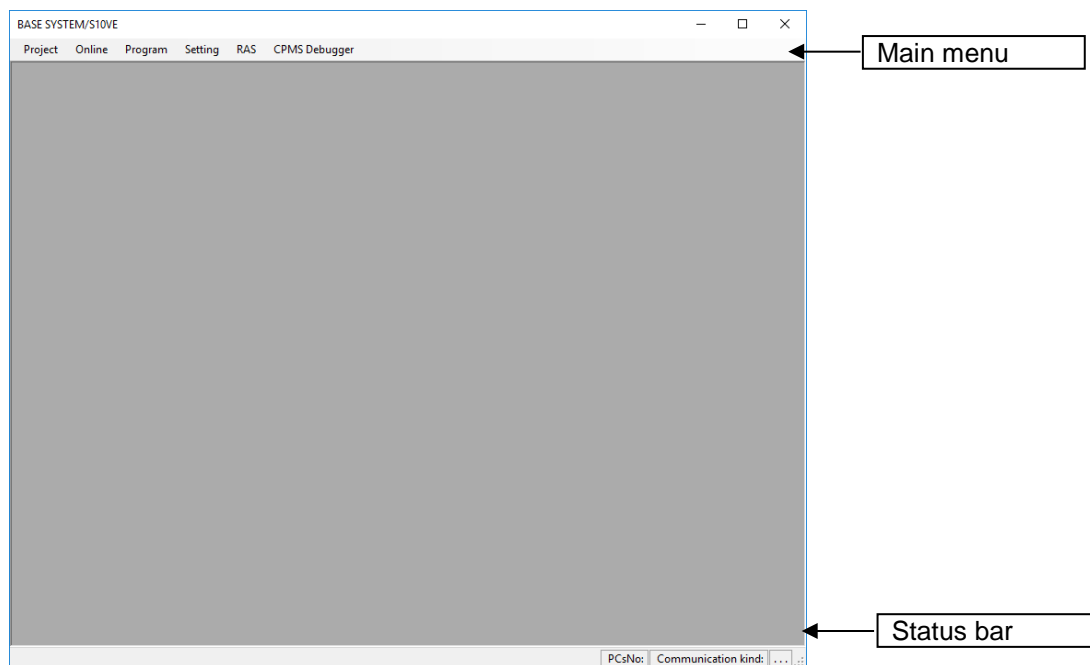

Figure 8-14 Layout of the BASE SYSTEM main window

8.4.1.1 Main menu

The following functions are available from the main menu:

- **Project:** A menu containing functions related to project files managed on the PADT side.
- **Online:** A menu that is available when there is a connection between the PADT and PCs.
- **Program:** A menu containing functions that start program tools (LADDER SYSTEM, HI-FLOW SYSTEM, and setup tools).
- **Setting:** A menu containing various setup functions.
- **RAS:** A menu containing various RAS functions.
- **CPMS Debugger:** A menu containing CPMS debugger functions.

8.4.1.2 Status bar

The status bar displays the following information:

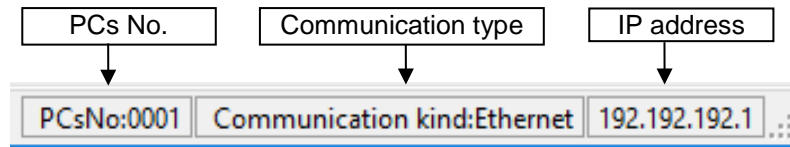

Figure 8-15 Status bar

- PCs No.: The PCs number of the project that is currently open, as a four-digit decimal number.
- Communication type: The method used for communication with the PCs. The communication type is always Ethernet.
Ethernet is also displayed for ET.NET connections.
- IP address: The IP address of the PCs to which BASE SYSTEM is connected.

8.4.2 Project functions

Project functions are available from the **Project** menu.

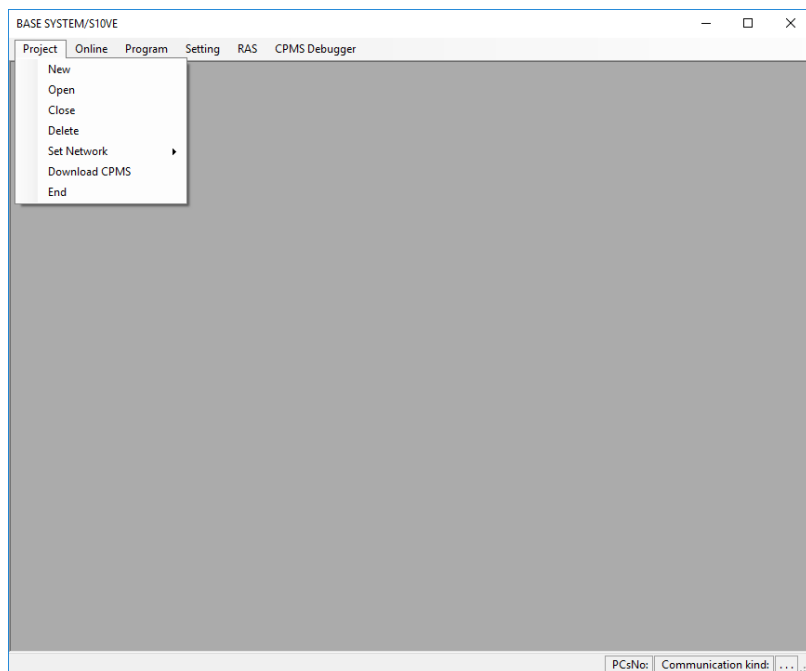

Figure 8-16 Window after clicking the Project menu

The following table lists and describes the project functions:

Table 8-2 List of Project menu items

No.	Category			Description	
	Level 1	Level 2	Level 3		
1	Project	New	--	Creates a new project.	
2		Open	--	Opens an existing project.	
3		Close	--	Closes the currently open project.	
4		Delete	--	Deletes an existing project.	
5		Set Network	Ethernet		Sets the IP address and routing information for the CPU module.
6			ET.NET		Sets the IP address and routing information for ET.NET.
7		Download CPMS	--	Replaces the CPMS of the connected PCs.	
8		End	--	Exits BASE SYSTEM and outputs an operation log.	

8.4.2.1 Project menu: New

Use this menu item to create a project file containing the information required to set up PCs.

To create a project that uses C mode, one way is to log on as an administrator with RPD P installed and start BASE SYSTEM normally. Another way is to log on as a user who belongs to the RPDUsers group and use temporary administrator privileges to start BASE SYSTEM.

<h2>Notice</h2>
<ul style="list-style-type: none">• You cannot log on using multiple user accounts and switch between them without logging off. You must log off before you can switch to another user account.

- (1) From the main menu, select **Project** and then **New**.
- (2) The Properties window appears.

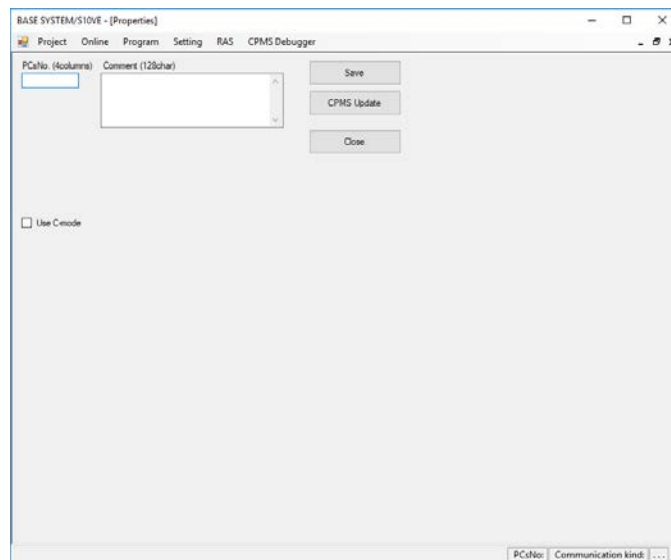

Figure 8-17 Properties window

If a Properties window is already open, the new window will appear when you close the existing one. If you have not saved the settings in the open Properties window, a message appears asking if you want to save the settings.

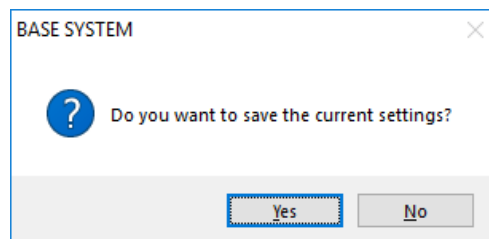

Figure 8-18 Save confirmation message

Click **Yes** to save the settings and close the project.
Click **No** to close the project without saving it.

(3) Set the following PCs parameters:

- **PCsNo.**

A number (0 to 9998) that identifies the PCs. This field is blank by default.

The PCs number is also the level at which BASE SYSTEM manages projects (sites).

- **Comment**

Set a comment (maximum 128 characters) that helps identify the PCs. This field is blank by default.

- **Use C-mode**

Select the **Use C-mode** check box to enable C mode (RPDP) for the project. This check box is cleared by default.

This check box will be unavailable if you open a saved project that uses C mode.

(4) To save the project with the settings you specified, click **Save**.

(a) Saving as a new project

If there is no existing project with the PCs number you specified, a new project is created.

If C mode is enabled for the project, BASE SYSTEM creates an RPDP site. If RPDP is not installed, the error message shown in Figure 8-19 appears:

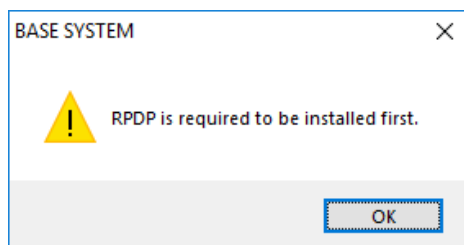

Figure 8-19 Error message when RPDP is not installed

In the following circumstances, an error message is output indicating that the user does not have permission to create a site:

- The logged-in user (does not apply to the administrator) does not belong to the RPDPusers group.
- The logged-in user (does not apply to the administrator) started BASE SYSTEM from a standard account.
- Multiple user accounts are logged in and the user has switched between them without logging off.

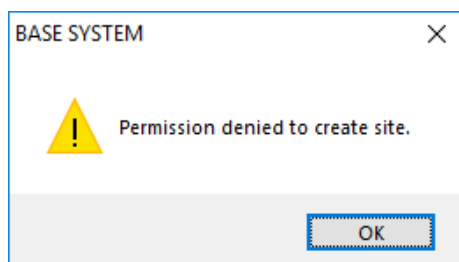

Figure 8-20 Error message indicating lack of site creation permission

(b) Overwriting an existing project

If a project with the specified PCs number already exists, a message appears asking you to confirm that you want to overwrite the project.

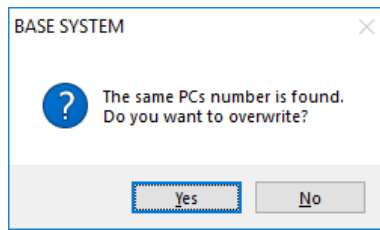

Figure 8-21 Overwrite confirmation message

Click **Yes** to overwrite the project.

Click **No** to cancel saving the project.

- Comment

The comment of the existing project is overwritten.

- CPMS

The CPMS of the existing project remains unchanged.

- C-mode usage

- If you enabled C-mode usage for the project, the system creates an RPDP site. However, RPDP must be installed for this to take place.

- If the existing project already has C-mode usage enabled, the RPDP site remains unchanged.

(c) Saving a project under a different PCs number (new project)

If you specify a new PCs number for an open project, the system makes a copy of the open project and assigns the copy the PCs number you specified.

- CPMS

The project is created using the CPMS of the open project. This means that the CPMS of the copy might differ from the CPMS that is currently installed.

- C-mode usage

- If C-mode usage is enabled for the open project, the system creates an RPDP site for the new project by copying the site of the open project.

- If C-mode usage is disabled for the open project, the copy cannot be saved with C-mode usage enabled. If you attempt to do so, the following message appears:

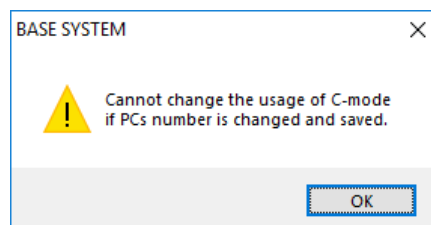

Figure 8-22 Error message indicating that C-mode usage setting cannot be changed

(d) Saving a project under an existing PCs number (overwrite existing project)

If you change the PCs number of an open project to a number that is already assigned to an existing project, the following message appears:

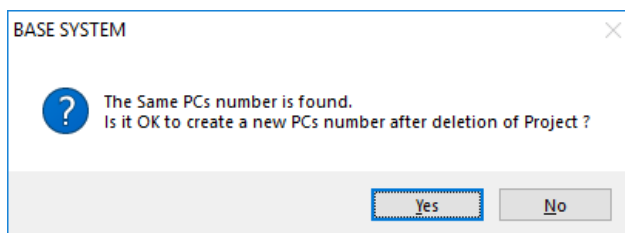

Figure 8-23 Message asking whether you want to create a project with an existing PCs number

If you click **Yes**, the system deletes the existing project with the specified PCs number, makes a copy of the open project, and creates another project using the settings of the open project.

Click **No** to cancel the save process.

- Comment

The comment of the existing project is overwritten.

- CPMS

The project is created using the CPMS of the open project. This means that the CPMS of the new project might differ from the CPMS that is currently installed.

- C-mode usage

- If C-mode usage is enabled for the project that is assigned the specified PCs, the system deletes the RPDP site.

However, if any of the following apply, the error message dialog box shown in Figure 8-24 appears and the RPDP site is not deleted:

- The logged-in user (does not apply to the administrator) does not belong to the `RPDPusers` group.
- The logged-in user (does not apply to the administrator) started `BASE SYSTEM` from a standard account.
- Multiple user accounts are logged in and the user has switched between them without logging off.

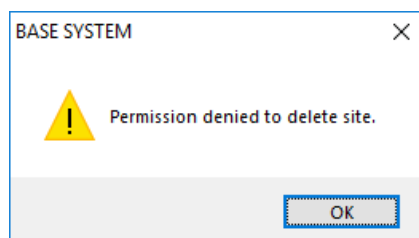

Figure 8-24 Error message indicating lack of site deletion permission

- If C-mode usage is enabled for the open project, the system copies and registers the site of the open project.

The conditions that determine whether the system can register a site are the same as in (a) *Saving as a new project*.

- If C-mode usage is disabled for the open project, the project that replaces it cannot be saved with C-mode usage enabled.

8. Tools

- (5) To update the CPMS file of the project to the currently installed file, click **CPMS Update**.
If C-mode usage is enabled, the RPDP site is also updated.
If any of the following apply, an error message dialog box appears:
- The logged-in user (does not apply to the administrator) does not belong to the `RPDPusers` group.
 - The logged-in user (does not apply to the administrator) started BASE SYSTEM from a standard account.
 - Multiple user accounts are logged in and the user has switched between them without logging off.

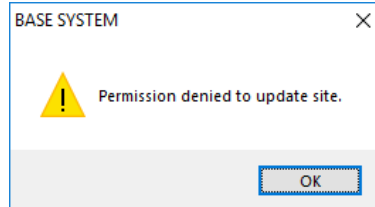

Figure 8-25 Error message indicating lack of site update permission

If RPDP is not installed, an error message to that effect appears (Figure 8-19).

- (6) Click **Close** to exit the project.
If you have entered a PCs number but not yet saved the project, a save confirmation message appears (Figure 8-18).

8.4.2.2 Project menu: Open

Use this menu item to open a project file. To open a project with C-mode usage enabled, start BASE SYSTEM after logging on as the administrator or a user who belongs to the `RPDPusers` group in an environment with RPDP installed.

- (1) From the main menu, select **Project** and then **Open**.
- (2) The Project List window appears.

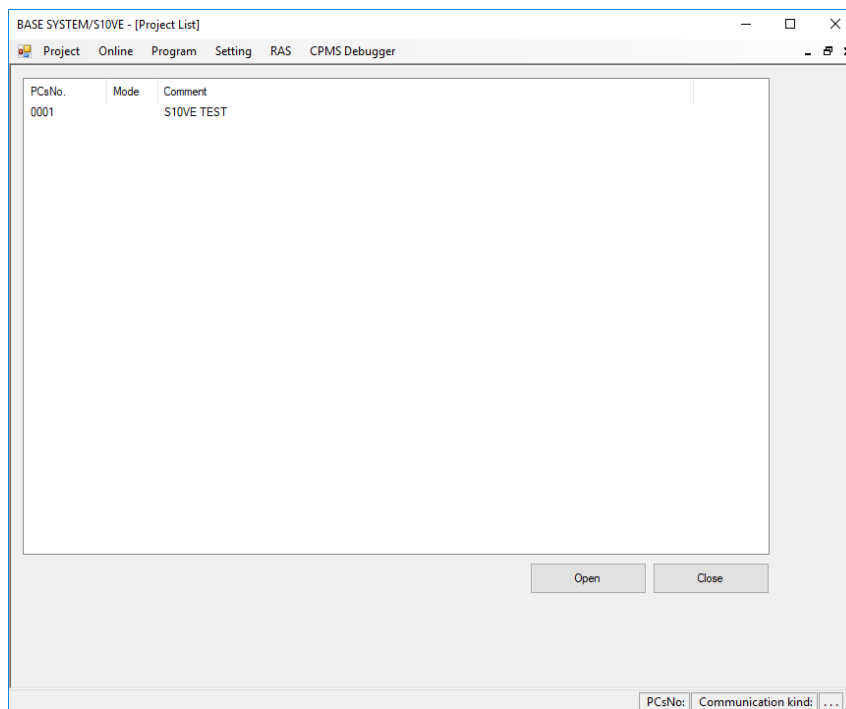

Figure 8-26 Project List window (opening a project)

- (3) The following parameters appear in the list:
 - **PCsNo.**
The PCs number of the project.
 - **Mode**
C is displayed if C-mode usage is enabled for the project.
 - **Comment**
The comment associated with the PCs.

8. Tools

- (4) To open a project, select the PCs number of the project you want to open from the list, and then click **Open**. The project opens and the Properties window (Figure 8-17) appears.

If a Properties window is already open, the Properties window for the selected project will appear when you close the open window. If you have not saved the settings in the open Properties window, a message appears asking if you want to save the settings (Figure 8-18).

If C-mode usage is enabled for the selected project but RPDP is not installed in your environment, an error message indicating that RPDP is not installed appears.

In either of the following circumstances, an error message is output indicating that the user does not have permission to use the site:

- The logged-in user (does not apply to the administrator) does not belong to the `RPDPusers` group.
- Multiple user accounts are logged in and the user has switched between them without logging off.

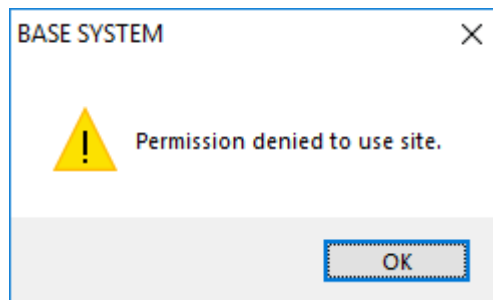

Figure 8-27 Error message indicating lack of site usage permission

- (5) To exit the Project List window, click **Close**.

8.4.2.3 Project menu: Close

Use this menu item to close a project file.

- (1) From the main menu, select **Project** and then **Close**.
- (2) The project file closes.

If you have not saved the settings in the open Properties window, a message appears asking if you want to save the settings (Figure 8-18).

8.4.2.4 Project menu: Delete

Use this menu item to delete a project file.

To delete a project that has C-mode usage enabled, you need to log on as an administrator with RPD P installed and start BASE SYSTEM normally, or log on as a user who belongs to the RPDUsers group and use temporary administrator privileges to start BASE SYSTEM.

Notice

- You cannot log on using multiple user accounts and switch between them without logging off. You must log off before you can switch to another user account.

- (1) From the main menu, select **Project** and then **Delete**.
- (2) The Project List window appears. For details on the information displayed in the Project List window, see 8.4.2.2 *Project menu: Open*.

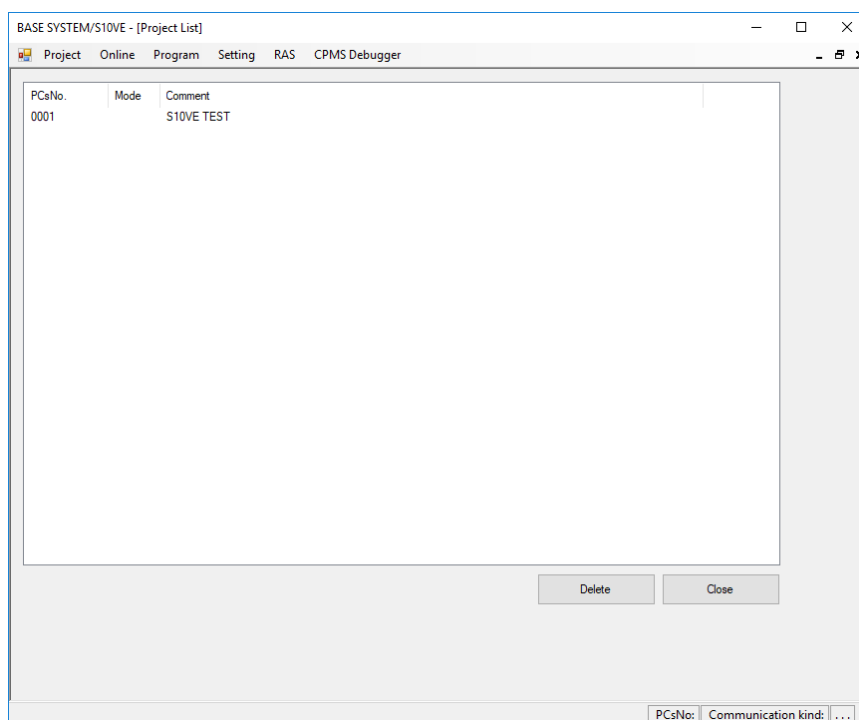

Figure 8-28 Project List window (deleting a project)

8. Tools

- (3) To delete a project, select the PCs number of the project you want to delete from the list, and then click **Delete**. A message appears asking you to confirm that you want to delete the project.

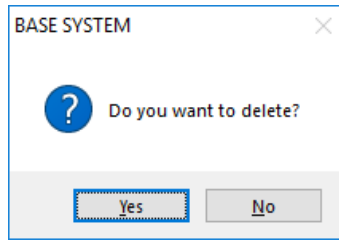

Figure 8-29 Deletion confirmation message

Click **Yes** to delete the project.

To cancel deletion of the project, click **No**.

If the project has C-mode usage enabled, the system will also delete the associated RPDP site.

If RPDP is not installed, an error message indicating that RPDP is not installed appears (Figure 8-19).

In any of the following circumstances, an error message is output indicating that the user does not have permission to delete the site (Figure 8-24):

- The logged-in user (does not apply to the administrator) does not belong to the `RPDPusers` group.
- The logged-in user (does not apply to the administrator) started `BASE SYSTEM` from a standard account.
- Multiple user accounts are logged in and the user has switched between them without logging off.

- (4) To close the Project List window, click **Close**.

8.4.2.5 Project menu: Set Network

The following explains how to set the network information for the CPU module and the ET.NET module. If the station number of the CPU module is 0xFF, the system operates with 192.192.192.1 as the IP address of the CPU module's built-in port Ethernet 1, and 192.192.193.1 as the IP address of its built-in port Ethernet 2. It does not use the settings you make in this window.

The network configuration is available by clicking the **Ethernet** or **ET.NET** menu item.

Menu item	Network type	Description
Ethernet	Ethernet 1	ET1 of CPU built-in Ethernet port
	Ethernet 2	ET2 of CPU built-in Ethernet port
ET.NET	ET.NET main	ET.NET option module (main)
	ET.NET sub	ET.NET option module (sub)

8.4.2.5.1 Network configuration of CPU built-in Ethernet

Set the network information of the CPU module.

If you intend to use only one Ethernet channel, use Ethernet 1. However, you must also set up Ethernet 2 so that the PADT can connect to the CPU module to perform maintenance.

When using two Ethernet channels for control purposes, you will need to reconfigure Ethernet 1 or Ethernet 2 if the need arises to connect the PADT via the CPU built-in Ethernet.

If the same port is used for control and for connecting the PADT, the performance on the control side is affected. For this reason, we recommend that you provide a dedicated port for PADT connection.

- (1) From the main menu, select **Project, Set Network**, and then **Ethernet**.
- (2) The Set Network window appears. Select the network you want to configure from the **Select Network** drop-down list. The settings registered in the CPU module appear.

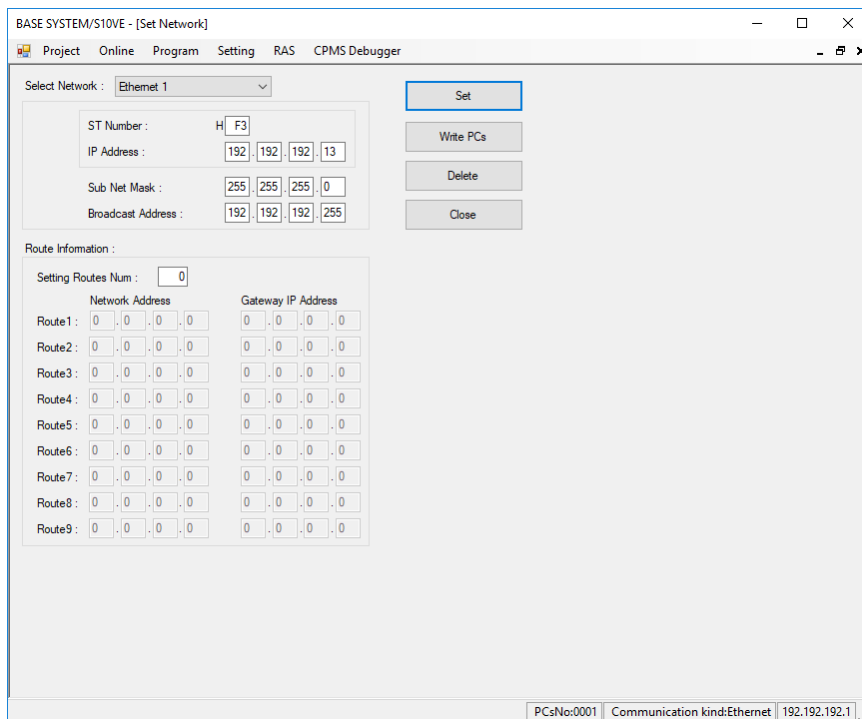

Figure 8-30 Set Network window

- (3) To set network information, enter the information for the selected network and then click **Set**. The information entered in the Set Network window when you click the **Set** button takes effect when you click the **Write PCs** button.

- **Select Network**

Select the type of network you want to configure.

Item	Description
Ethernet 1	Settings for CPU module built-in Ethernet port ET1
Ethernet 2	Settings for CPU module built-in Ethernet port ET2

- **ST Number, IP Address, Sub Net Mask, and Broadcast Address**

Set the station number, IP address, subnet mask, and broadcast address of the network selected in **Select Network**. As the station numbers of Ethernet 1 and Ethernet 2, set the same setting as the ET ST.No. switch of the CPU module.

If you enter a different station number and click **Set**, a message appears asking you to confirm the overwriting of the station number of the other Ethernet station.

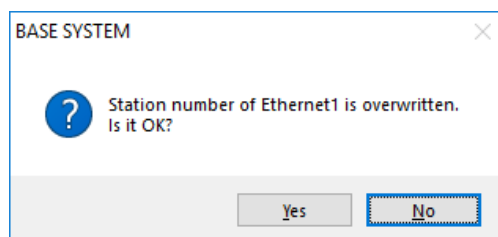

Figure 8-31 Message asking for confirmation of Ethernet station number overwrite

Note: If you overwrite the station number for Ethernet 2, the message Station number of Ethernet2 is overwritten. Is it OK? appears.

Click **Yes** to apply the settings including the new station number.

To cancel the settings, click **No**.

- **Setting Routes Num, Network Address, and Gateway IP Address**

To configure the routing table, set the number of routes and the network address and gateway IP address of each route.

You can set a maximum of nine routes in total across Ethernet 1 and Ethernet 2.

8. Tools

- (4) To delete network information, select the network in **Select Network** whose information you want to delete, and then click **Delete**. The displayed network information is cleared.
If you click the **Write PCs** button after clicking **Delete**, the network information set on the PCs is deleted.
- (5) To replace the network information on the PCs with the information you set, click the **Write PCs** button.
After writing the information to the PCs, the system displays a message asking you to confirm that you want to reset the PCs.

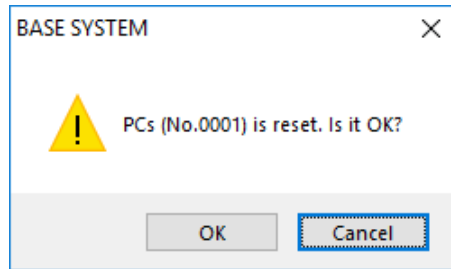

Figure 8-32 Reset confirmation message

Click the **OK** button to reset the PCs.

If you click **Cancel**, the PCs are not reset.

If BASE SYSTEM successfully resets the PCs, it displays a message to that effect.

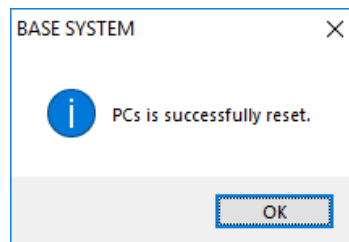

Figure 8-33 Reset successful message

If the reset fails, BASE SYSTEM displays a message reporting that the reset was not successful.

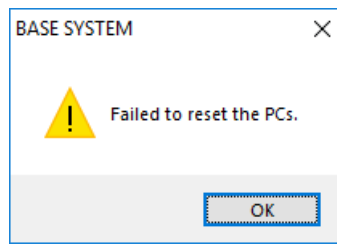

Figure 8-34 Reset failed message

In this case, you will need to reset the PCs manually.

There are two ways to manually reset the PCs:

- Turn the CPU RUN/STOP switch from RUN to STOP and then back to RUN.
- Turn the PCs off and then on again.

(6) Click **Close** to close the Set Network window.

8.4.2.5.2 ET.NET configuration

- (1) Set the network information for ET.NET.
From the main menu, select **Project, Set Network**, and then **ET.NET**.
- (2) The Set Network (ET.NET) window appears.

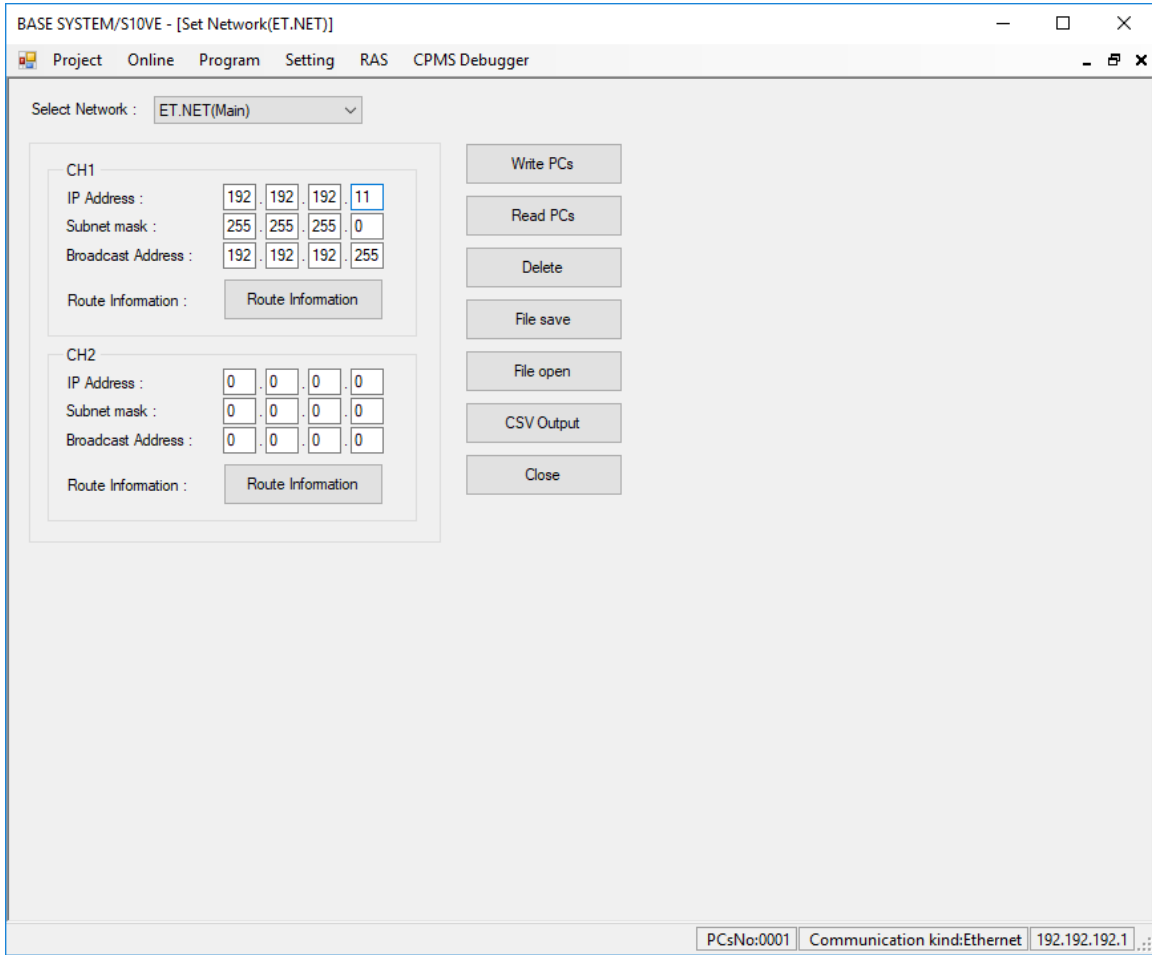

Figure 8-35 Set Network (ET.NET) window

- (3) Select the ET.NET module (main or sub) whose network you want to configure from the **Select Network** drop-down list.

Item	Description
ET.NET(Main)	Sets network information for the ET.NET main module.
ET.NET(Sub)	Sets network information for the ET.NET sub-module.

Note: You can configure a maximum of two ET.NET modules, one designated the main module and the other the sub-module.

-IP Address, Sub Net Mask, and Broadcast Address

Set the IP address, subnet mask, and broadcast address of the network selected in **Select Network**.

- Setting Routes Num, Network Address, and Gateway IP Address

To configure the routing table, click the applicable **Route Information** button in the Set Network (ET.NET) window. The Route Information window appears.

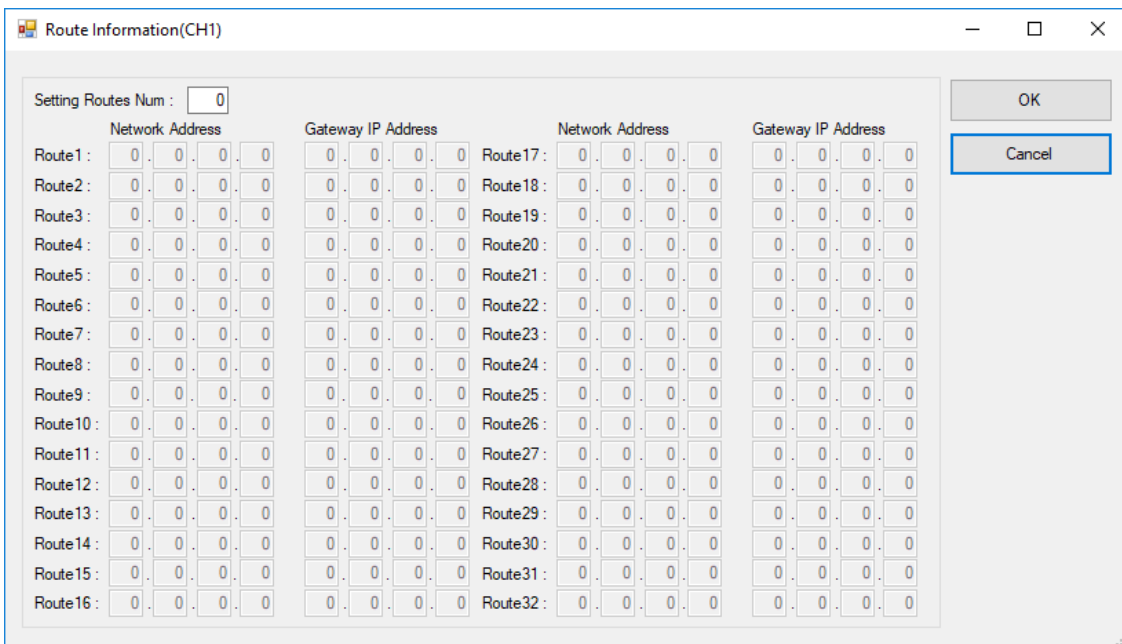

Figure 8-36 Route Information window

Set the **Setting Routes Num**, **Network Address**, and **Gateway IP Address** values.

You can define a maximum of 32 routes.

After entering the information, click **OK** to return to the Set Network (ET.NET) window.

If you click **Cancel**, the settings you entered are discarded and you are returned to the Set Network (ET.NET) window.

- (4) To replace the network information on the PCs with the network information you set, click the **Write PCs** button in the Set Network (ET.NET) window. The Option module parameter setup list window appears.

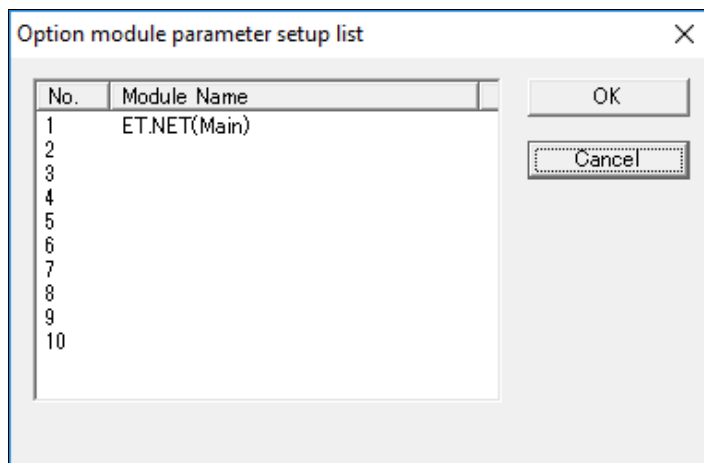

Figure 8-37 Option module parameter setup list window

Select the number of the module whose parameters you want to set, and then click **OK**. The network information you set in the Set Network (ET.NET) window is written to the selected module.

If you click **Cancel**, you are returned to the Set Network (ET.NET) window without any settings being written to the PCs.

If network information is already set for the selected module, a message appears asking you to confirm that you want to overwrite the information.

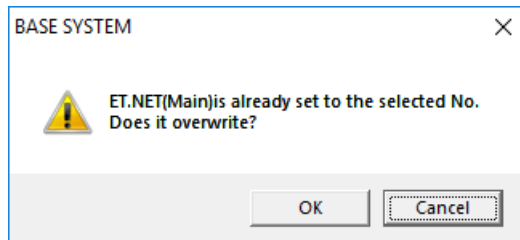

Figure 8-38 Overwrite confirmation message

To overwrite the existing settings, click **OK**. The system writes the new settings to the PCs. If you do not want to overwrite the existing settings, click **Cancel**. You will be returned to the Option module parameter setup list window (Figure 8-37) without any settings being written to the PCs.

You cannot apply the same network settings to more than one option module.

If the same settings are already applied to an option module, a message appears that notifies you of this fact and asks you if you want to clear the settings.

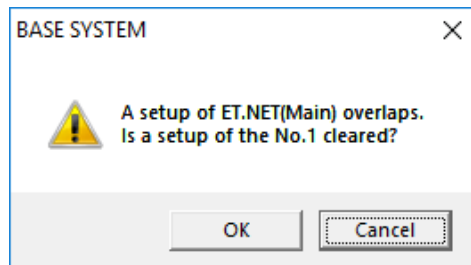

Figure 8-39 Message confirming removal of duplicate settings

If you click **OK**, the system writes the network information you input to the selected option module, and removes the settings from the option module to which the settings were already applied.

If you click **Cancel**, the system does not write the network information to the selected module.

- After writing to the PCs, the system displays a message that notifies you that the PCs will be reset and asks for confirmation (Figure 8-40).

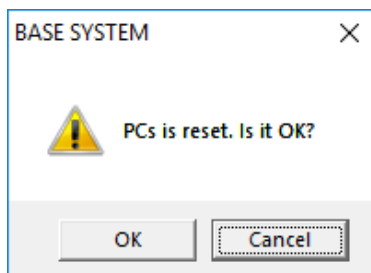

Figure 8-40 Reset confirmation message

Click **OK** to reset the PCs.

If you click **Cancel**, the PCs are not reset.

- If BASE SYSTEM successfully resets the PCs, it displays a message to that effect (Figure 8-41).

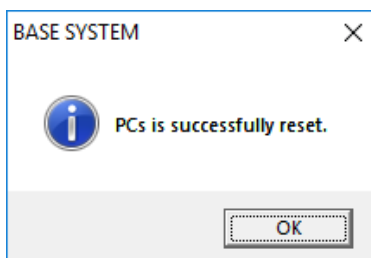

Figure 8-41 Reset successful message

- If the reset fails, the system displays a message reporting that the reset was not successful (Figure 8-42).

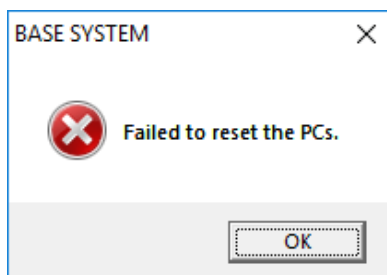

Figure 8-42 Reset failed message

In this case, you will need to reset the PCs manually.

There are two ways to manually reset the PCs:

- Turn the CPU RUN/STOP switch from RUN to STOP and then back to RUN.
- Turn the PCs off and then on again.

8. Tools

- (5) To display the network information registered on the PCs, click the **Read PCs** button in the Set Network (ET.NET) window. The system reads the information from the PCs and displays it on the screen.
- (6) To use network information that has been saved to a file, select the ET.NET module (main or sub) whose network you want to configure from the **Select Network** drop-down list, and then click the **File open** button. An Open window (Set Network (ET.NET)) appears.

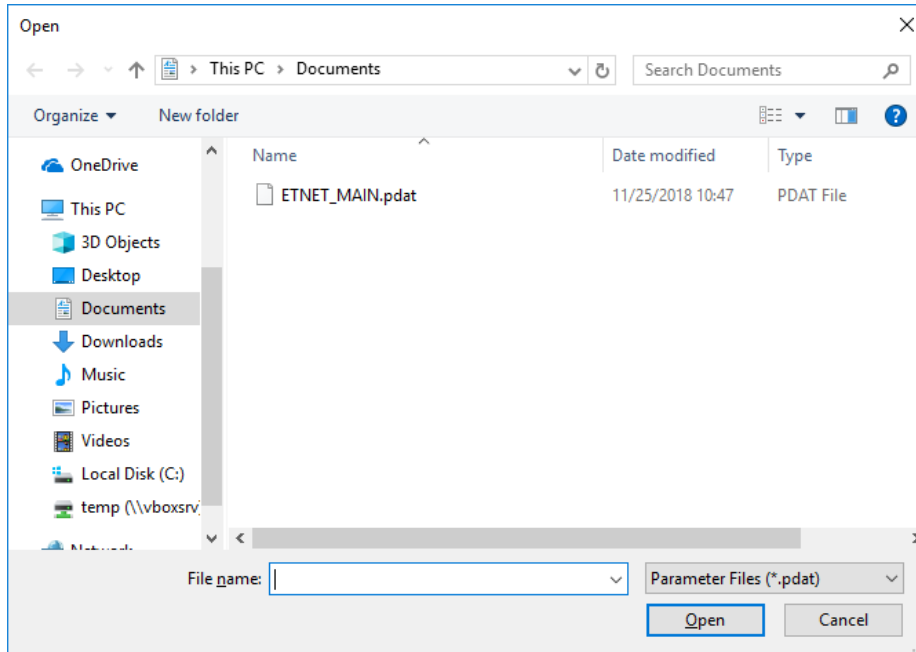

Figure 8-43 Open window (Set Network (ET.NET))

Select the file that contains the network information you want to use, and then click **Open**. Files that contain network information will have the extension `.pdat`.

When you click **Open**, the File open window appears.

If you click **Cancel**, the Open window (Set Network (ET.NET)) closes.

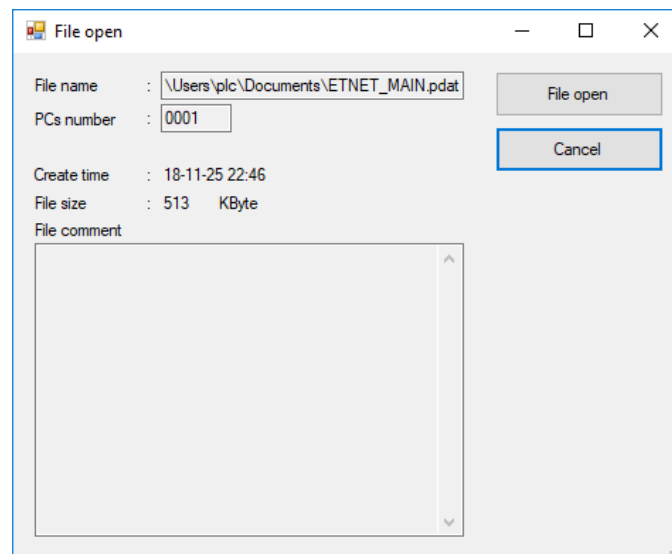

Figure 8-44 File open window

View the file name and comment in the File open window to make sure that the file is the correct one. If it is the correct file, click **File open**. You are returned to the Set Network (ET.NET) window, which now displays the network information read from the file.

If the information in the selected file does not relate to the selected ET.NET network, a message appears indicating that the wrong file was selected. Click **OK** to dismiss the message. You will be returned to the Set Network (ET.NET) window.

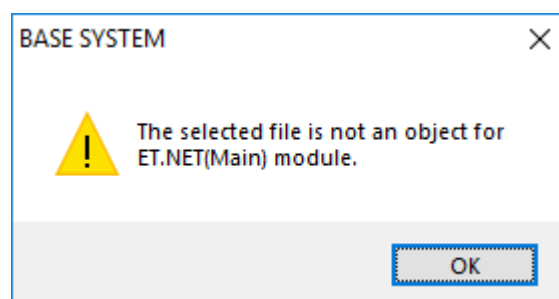

Figure 8-45 Wrong file selected message

- (7) To delete network information, click the **Delete** button in the Set Network (ET.NET) window. The Option module parameter setup list window (deletion) (Figure 8-46) appears. If you click **Cancel**, you are returned to the Set Network (ET.NET) window without any option module parameters being deleted.

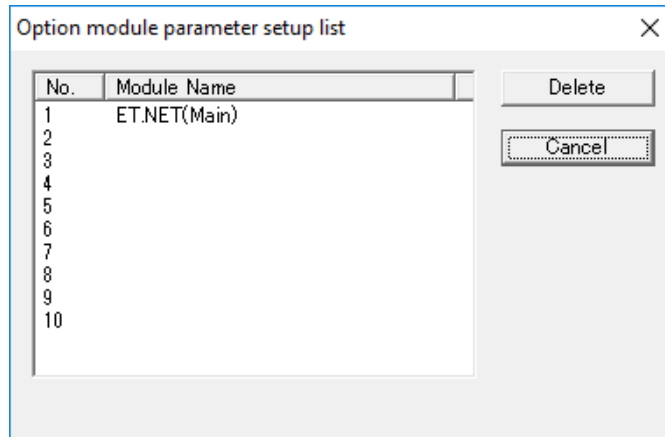

Figure 8-46 Option module parameter setup list window (deletion)

Select the module whose parameters you want to delete, and then click **Delete**. If option module parameters are set for the selected module, a message appears asking you to confirm that you want to delete the parameters.

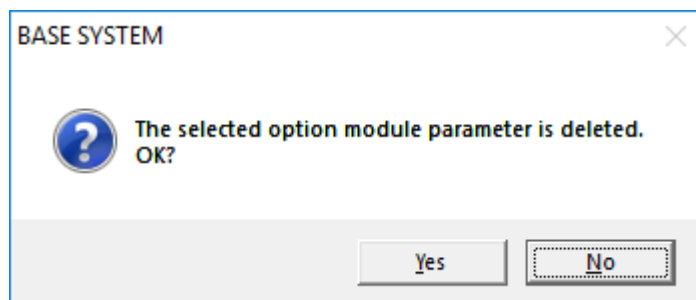

Figure 8-47 Confirm deletion message

To delete the option module parameters, click **Yes**. If you do not want to delete the parameters, click **No**. You will be returned to the Option module parameter setup list window (deletion) (Figure 8-46) without any parameters being deleted.

- (8) To save the network information you input to a file, click the **File save** button in the Set Network (ET.NET) window. A Save As dialog box appears.

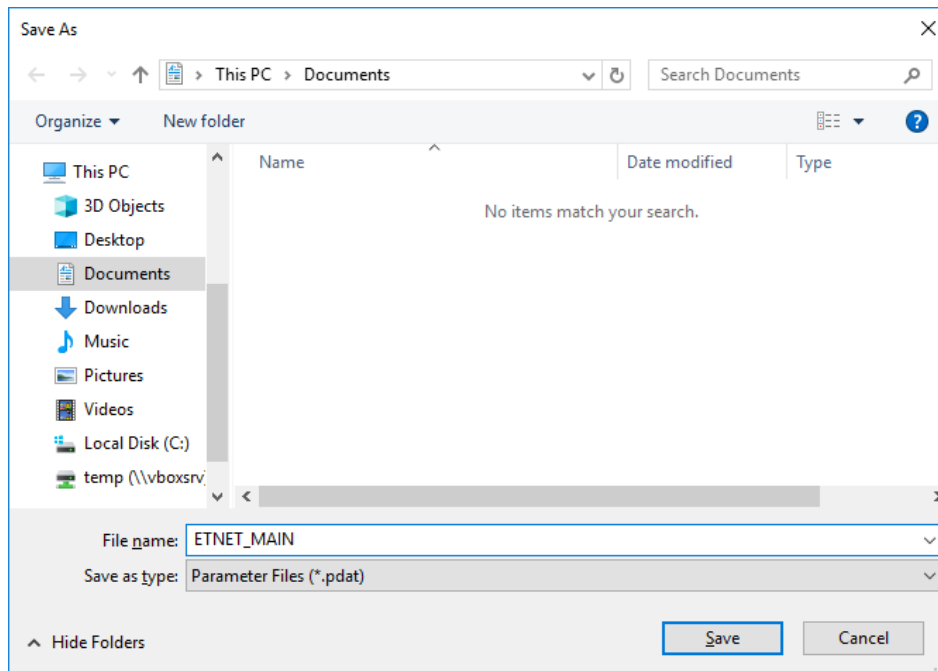

Figure 8-48 Save As dialog box

In the Save As dialog box, specify the name of the file to which you want to save the network information.

If you click **Save**, the File save window appears.

If you click **Cancel**, the Save As dialog box closes.

8. Tools

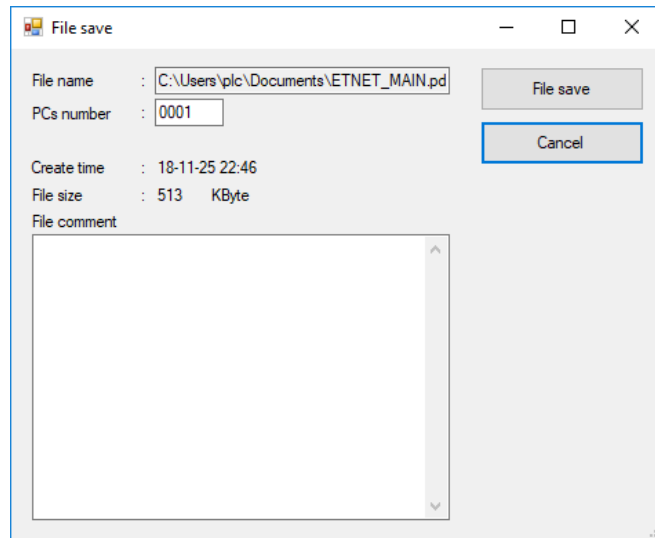

Figure 8-49 File save window

In the File save window, enter a comment about the file as needed. You can use a maximum of 512 characters. You can also change the PCs number in this window.

Click **File save** to save the file with the specified file name. The file will now be available to select when you click the **File open** button, or can be used by functions that send and receive data.

If you click **Cancel**, you are returned to the Set Network (ET.NET) window without saving the file.

- (9) You can output network information in CSV format by clicking the **CSV Output** button in the Set Network (ET.NET) window.

The format of the CSV file is as follows:

```

ET.NET YYYY/MM/DD    hh:mm:ss          ---- (1)
File Name=XXXXXXXXXXXXXXXXXXXXXXXXXX  ---- (6)
(Connection Type)    ---- (2)
PCsNo.: XXXX        ---- (3)
ET.NET(Main)        ---- (4)

CH1                  ---- (5)
  IP Address,XXX.XXX.XXX.XXX
  Subnet mask,XXX.XXX.XXX.XXX
  Broadcast Address,XXX.XXX.XXX.XXX

Route Information
Network Address, Gateway IP Address
Route1,XXX.XXX.XXX.XXX,XXX.XXX.XXX.XXX
Route2,XXX.XXX.XXX.XXX,XXX.XXX.XXX.XXX
Route3,XXX.XXX.XXX.XXX,XXX.XXX.XXX.XXX
Route4,XXX.XXX.XXX.XXX,XXX.XXX.XXX.XXX
      :
Route27,XXX.XXX.XXX.XXX,XXX.XXX.XXX.XXX
Route28,XXX.XXX.XXX.XXX,XXX.XXX.XXX.XXX
Route29,XXX.XXX.XXX.XXX,XXX.XXX.XXX.XXX
Route30,XXX.XXX.XXX.XXX,XXX.XXX.XXX.XXX
Route31,XXX.XXX.XXX.XXX,XXX.XXX.XXX.XXX
Route32,XXX.XXX.XXX.XXX,XXX.XXX.XXX.XXX

CH2
  IP Address,XXX.XXX.XXX.XXX
  Subnet mask,XXX.XXX.XXX.XXX
  Broadcast Address,XXX.XXX.XXX.XXX
Route Information
Network Address, Gateway IP Address
Route1, XXX.XXX.XXX.XXX,XXX.XXX.XXX.XXX
Route2, XXX.XXX.XXX.XXX,XXX.XXX.XXX.XXX
      :
Route31, XXX.XXX.XXX.XXX,XXX.XXX.XXX.XXX
Route32, XXX.XXX.XXX.XXX,XXX.XXX.XXX.XXX

```

8. Tools

Description of CSV file contents

- | | |
|---|--|
| (1) Date and time | The date and time the file was created, in the format
<i>YYYY/MM/DD hh:mm:ss</i> |
| (2) Connection type | Ethernet |
| (3) Project number (PCs number) | Output as a decimal number |
| (4) Module type | For the main ET.NET module: <i>ET.NET(Main)</i>
For the ET.NET sub-module: <i>ET.NET(Sub)</i> |
| (5) Network information for CH1 and CH2 | The parameter settings for channels 1 and 2. |
| (6) Name of settings file (.pdat) | This item is not output if the setting parameters were not read from a file. |

(10) Click **Close** to close the Set Network (ET.NET) window.

8.4.2.6 Project menu: Download CPMS

Use this menu item to download CPMS to the CPU module.

Confirm the following before downloading CPMS:

- [1] The PADT is not connected to the ET.NET module.
 - [2] The RUN/STOP switch of the CPU module is set to RUN.
- (1) From the main menu, select **Project** and then **Download CPMS**.
You will be unable to use this feature if the communication type is ET.NET. In this case, the following message appears:

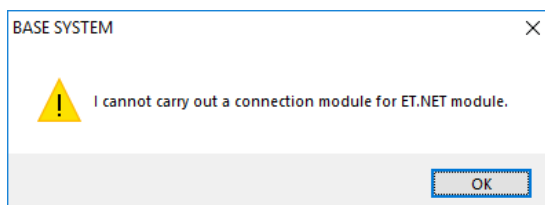

Figure 8-50 Error message when connected to ET.NET module

- (2) The Download CPMS window appears.

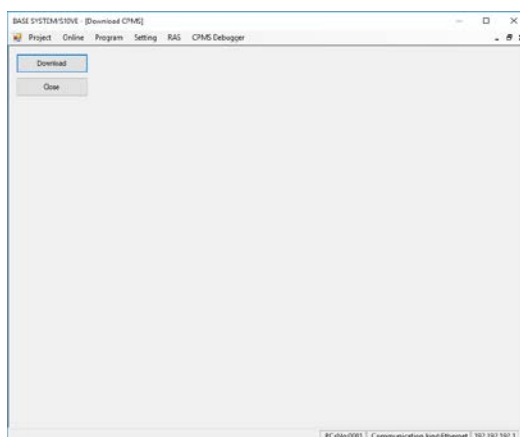

Figure 8-51 Download CPMS window

- (3) Click **Download** to download the CPMS.
You cannot use this function if the RUN/STOP switch of the CPU module is set to STOP. In this case, the following error message appears:

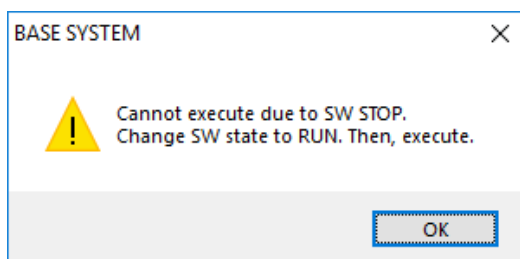

Figure 8-52 Error message when CPU switch is set to STOP

8. Tools

- (4) If CPMS has already been downloaded to the module, the system displays a message asking you to confirm that you want to reset the PCs (Figure 8-32).
Click **OK** to begin the download process.
To cancel the download, click **Cancel**.
If the download fails to start, an error message appears indicating that the data could not be read.
In this case, check the communication path and review the ST numbers in the Change PCs window, and then try downloading the CPMS again.
- (5) The following window appears during the CPMS download, which displays the progress of the download.

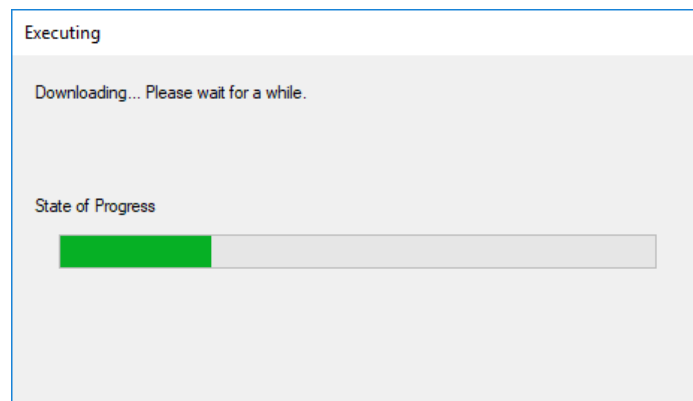

Figure 8-53 Progress window (download)

- If the ROM load operation fails during CPMS download, the system displays a message asking you to confirm re-execution of the ROM load operation (Figure 8-54).

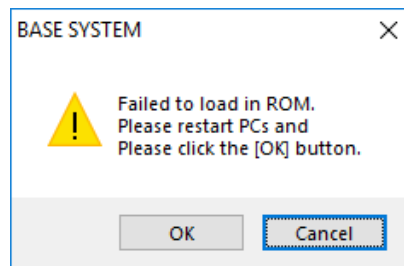

Figure 8-54 Confirmation of ROM load re-execution message

If this message appears, turn the PCs off and on again, and then click **OK**.
If you click **Cancel**, the system displays an error message indicating that the ROM load operation has failed (Figure 8-55).

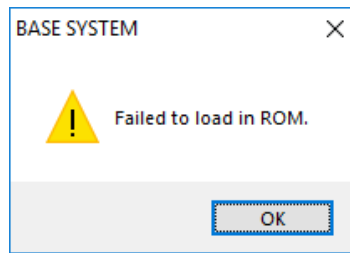

Figure 8-55 ROM load failure error message

If the message asking for confirmation of ROM load re-execution (Figure 8-54) appears again when you click **OK**, click **Cancel** and use the information provided by the CPU indicators to identify and resolve the fault. For details on how to perform fault analysis, see *Chapter 13. Troubleshooting*. For details about the ROM load operation, see *SDRAM state during ROM load operation* in 8.5.5 *Scope of backup, restoration, and comparison*.

- (6) When the CPMS download has completed, a **Close** button appears in the progress window. The system assigns the PCs number of the open project to the PCs. Information about the S10VE system is loaded into BASE SYSTEM and displayed in the status bar.
- (7) Click **Close** to close the Download CPMS window.

Note:

The CPU enters STOP mode while the CPMS is being downloaded. When the download is complete, the CPU returns to RUN mode.

8.4.2.7 Project menu: End

Use this menu item to exit the application and output an operation log.

- (1) From the main menu, select **Project** and then **End**.
- (2) The confirmation message shown in Figure 8-56 might appear. If it appears, you might have clicked **Cancel** when asked by BASE SYSTEM to confirm a reset that was required to apply settings to PCs. Alternatively, you might have clicked **OK** but the reset failed.

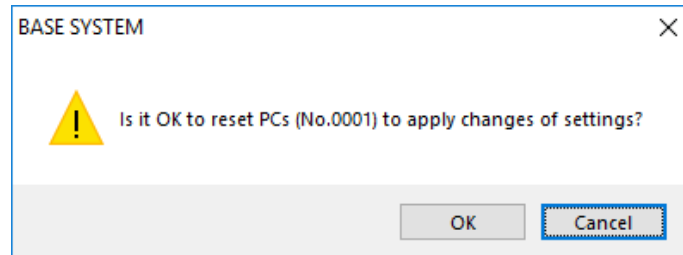

Figure 8-56 Reset confirmation message (end)

Click **OK** to reset the PCs.

If you click **Cancel**, the PCs are not reset.

If the reset is successful, the system displays a message to that effect (Figure 8-33).

If the reset fails, the system displays a message reporting that the reset was not successful (Figure 8-34).

- (3) The system outputs an operation log.
For details about the contents of the operation log file, see *8.6.1 Operation history recording function*.
The following error message appears if the logged-on user does not have permission to write to the file:

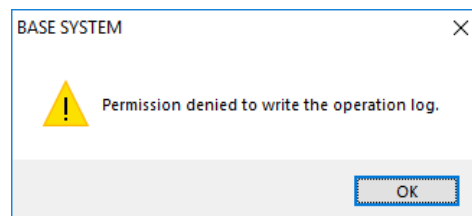

Figure 8-57 Error message when user does not have operation log write permission

- (4) Exit BASE SYSTEM.

8.4.3 Online functions

Online functions are available from the **Online** menu.

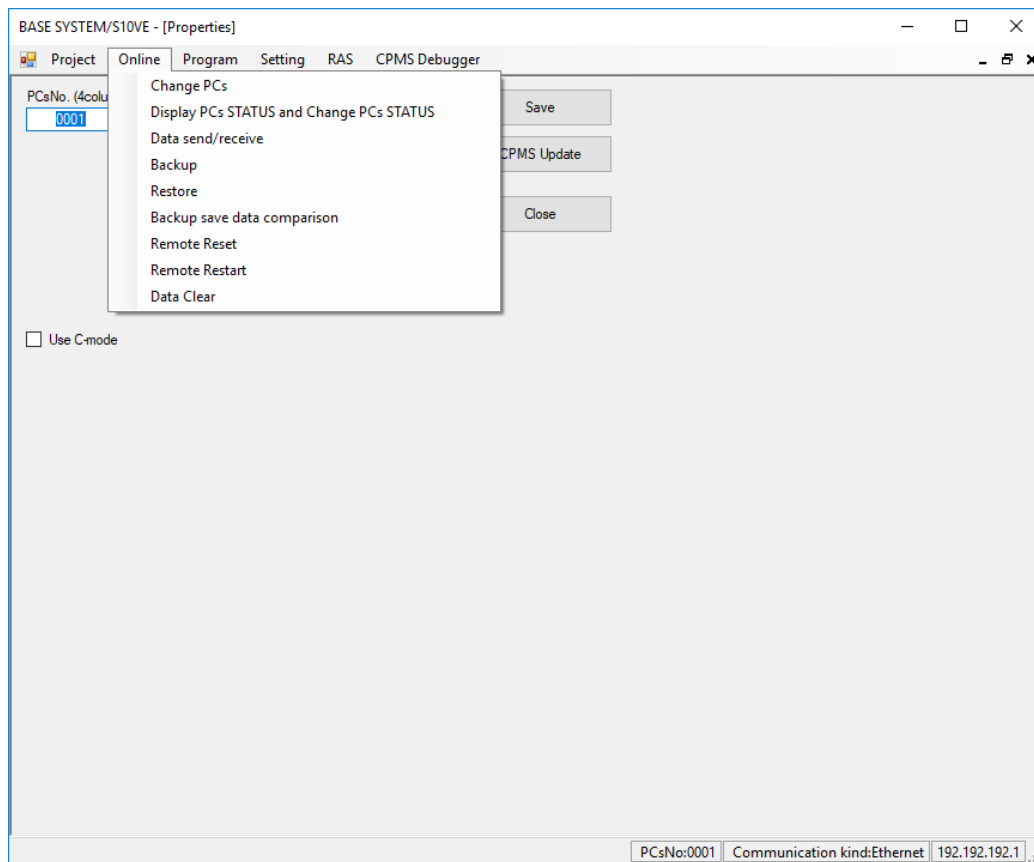

Figure 8-58 Window after clicking the Online menu

The following table lists and describes the online functions:

Table 8-3 List of Online menu items

No.	Category			Description
	Level 1	Level 2	Level 3	
1	Online	Change PCs	--	Sets the communication type used for communication with the PCs.
2		Display PCs STATUS and Change PCs STATUS	--	Displays or changes the status of the PCs.
3		Data send/receive	--	Sends, receives, and compares the setting information for option modules.
4		Backup	--	Receives CPU data from the PCs.
5		Restore	--	Sends backup data to PCs for restoration.
6		Backup save data comparison	--	Compares backup data with data on the PCs.
7		Remote Reset	--	Resets the PCs.
8		Remote Restart	--	Restarts the PCs.
9		Data Clear	--	Clears the PCs data.

8.4.3.1 Online menu: Change PCs

Use this menu item to set the communication type used for connections with the PCs.

- (1) From the main menu, select **Online** and then **Change PCs**.
- (2) The Change PCs window appears.

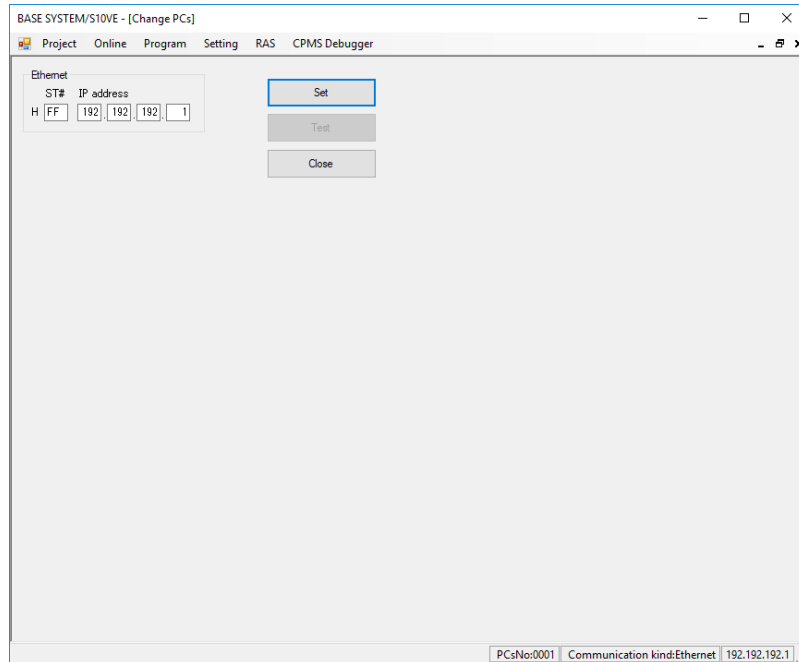

Figure 8-59 Change PCs window

- (3) Set the communication type (station number and IP address).
- (4) Click **Set** to assign the communication type you entered to the project.
- (5) To check whether communication is possible with the communication type you set, place the CPU module in RUN mode and then click **Test**. If BASE SYSTEM was able to successfully communicate with the CPU module, it displays a message acknowledging a successful PCs connection (Figure 8-60).

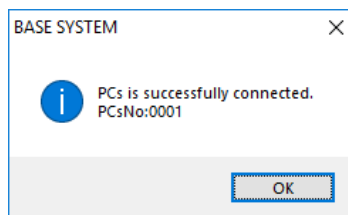

Figure 8-60 Message when PCs connection is successful

The **Test** button is unavailable immediately after you change the communication type. To make the **Test** button available, you must click **Set**.

- (6) Click **Close** to close the Change PCs window.

8.4.3.2 Online menu: Display PCs STATUS and Change PCs STATUS

Use this menu item to display and change the status of the PCs.

- (1) From the main menu, select **Online** and then **Display PCs STATUS and Change PCs STATUS**.
- (2) The PCs Status window appears.

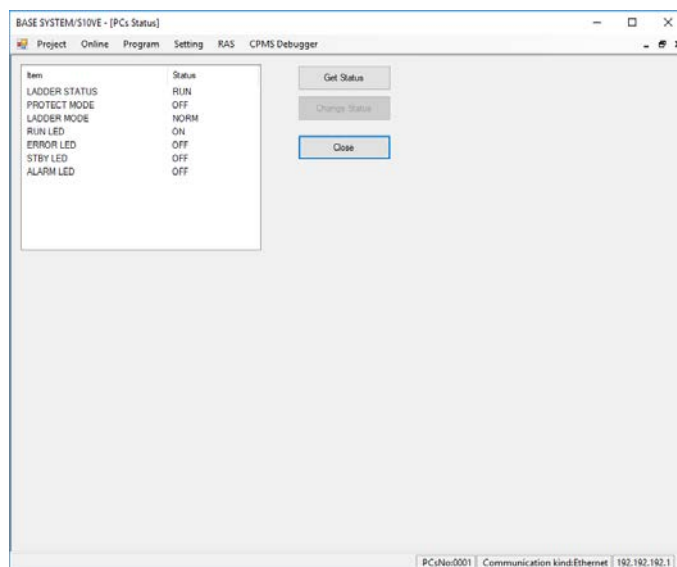

Figure 8-61 PCs Status window

- (3) The PCs Status window displays the status of the PCs in a list. To update the status information to the latest information, click **Get Status**. To change PCs status, select it from the list and then click **Change Status**.

LADDER STATUS

Displays the operating status of ladder logic on the PCs.

Status	Description
RUN	Ladder logic is running.
STOP	Ladder logic is stopped.

You can change the RUN/STOP status of the PCs if the LADDER RUN/STOP switch of the CPU module is set to RUN, and STOP/RUN contact input is OFF on the terminal block. If the LADDER RUN/STOP switch of the CPU module is set to STOP or STOP/RUN contact input is ON on the terminal block, clicking the **Change Status** button has no effect.

The STOP status set by this tool remains in effect until you reset the CPU module or turn it off and on again.

After you reset the CPU module or turn it off and on again, the PCs operates according to the setting of the LADDER RUN/STOP switch.

PROTECT MODE

Sets whether to operate arithmetic functions in protection mode.

Status	Description
ON	Ladder arithmetic functions operate in protection mode.
OFF	Ladder arithmetic functions operate without protection mode.

When protection mode is enabled, the ladder program stops if an arithmetic function running on the SH processor performs write access to any of the areas listed in the following table. At this time, the system also outputs a data access protection error to the error log.

No.	Address range	Description
1	0x0000 0000 to 0x001F FFFF	Outside the PI/O area
2	0x0047 2000 to 0x0047 FFFF	RI/O trace area and system area
3	0x004B 0000 to 0x004B 1FFF	S10V-compatible option module setting area
4	0x004C B000 to 0x004E FFFF	Error log area
5	0x004F 2000 to 0x004F 9FFF	System area
6	0x0110 0000 or above	Outside the user area

The following table lists the arithmetic functions that run on the SH processor:

No.	Category	Symbol	Remarks
1	Batch transfer	MOM	
2	Batch transfer of identical data	INI	
3	FIFO write	PSH	
4	FIFO read	POP	
5	FIFO write	PSHO	
6	FIFO read	POPO	
7	Address set	AST	
8	Search	SCH	
9	BIN → BCD	BTD	
10	BCD → BIN	DTB	

No.	Category	Symbol	Remarks
11	BIN → 7SEG	SEG	
12	BIN → ASCII	ASP	
13		ASU	
14	ASCII → BIN	APB	
15		AUB	
16	Decode	DCD	
17	Encode	ECD	
18	Square root	SQR	
19	Sine	SIN	
20	Cosine	COS	
21	Tangent	TAN	
22	Arcsine	ASIN	
23	Arccosine	ACOS	
24	Arctangent	ATAN	
25	Exponent	EXP	
26	Natural logarithm	LOG	
27	Clear	XCLR	
28		YCLR	
29		GCLR	
30		RCLR	
31		KCLR	
32		TCLR	
33		UCLR	
34		CCLR	
35		VCLR	
36		ECLR	
37		FCLR	

No.	Category	Symbol	Remarks
38	TCP communication	TOP	
39		TPOP	
39		TPOP	
40		TCLO	
41		TRCV	
42		TSND	
43	UDP communication	UOP	
44		UCLO	
45		URCV	
46		USND	

The scale conversion (SCL) function also runs on the SH processor when the Long data type is specified as an argument. All arithmetic functions operate on the SH processor when index specification is specified as an argument.

To prevent malfunction stemming from user programming errors, we recommend that you keep protection mode enabled (ON) unless you have a reason not to.

LADDER MODE

Specifies whether to run ladder programs in normal mode or in simulation mode.

Status	Description
NORM	Ladder programs run normally.
SIMU	Ladder programs run in simulation mode.

You can switch the LADDER MODE setting when the LADDER STATUS is RUN.

RUN LED

Shows the state of the RUN LED of the CPU module. For details about the LED states, see *5.3 CPU module* and *11.4.2 State transitions*.

Status	Description
ON	The RUN LED of the CPU module is lit.
OFF	The RUN LED of the CPU module is off.
BLINK	The RUN LED of the CPU module is blinking.

You cannot change the status of this item using the **Change Status** button.

ERR LED

Shows the state of the ERR LED of the CPU module. For details about the LED states, see *5.3 CPU module* and *11.4.2 State transitions*.

Status	Description
ON	The ERR LED of the CPU module is lit.
OFF	The ERR LED of the CPU module is off.

You cannot change the status of this item using the **Change Status** button.

STBY LED

Shows the state of the STBY LED of the CPU module. For details about the LED states, see *5.3 CPU module* and *11.4.2 State transitions*.

Status	Description
ON	The STBY LED of the CPU module is lit.
OFF	The STBY LED of the CPU module is off.
BLINK	The STBY LED of the CPU module is blinking.

You cannot change the status of this item using the **Change Status** button.

ALARM LED

Shows the state of the ALARM LED of the CPU module. For details about the LED states, see 5.3 *CPU module* and 11.4.2 *State transitions*.

Status	Description
ON	The ALARM LED of the CPU module is lit.
OFF	The ALARM LED of the CPU module is off.

You cannot change the status of this item using the **Change Status** button.

- (4) Click **Close** to close the PCs Status window.

8.4.3.3 Online menu: Data send/receive

Use this item to send, receive, and compare option module settings.

- (1) From the main menu, select **Online** and then **Data send/receive**.
- (2) The Data Send/Receive (Option Module) window appears.

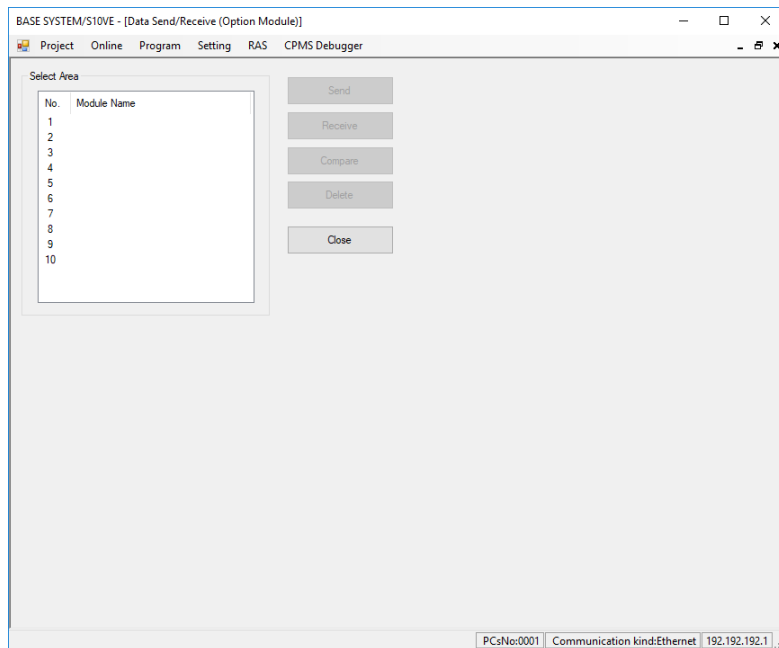

Figure 8-62 Data Send/Receive (Option Module) window

8.4.3.3.1 Sending data

Perform the following procedure to send option module settings to the PCs:

- (1) Select the area number to which you want to send the settings, and then click **Send**.
You can send settings to an area whose module name is blank, or which is assigned the same module type and module number as the option module settings you are sending.
- (2) An Open window appears. Select the file that you want to send.

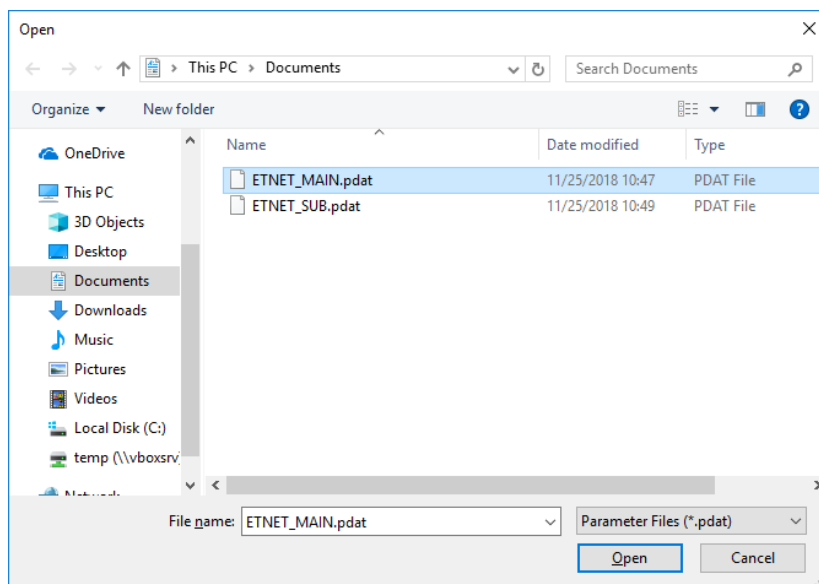

Figure 8-63 Open window (Data Send/Receive)

When you click **Open**, the Open window closes and the Send Data window appears. To close the Open window, click **Cancel**.

- (3) Check the file information in the Send Data window.

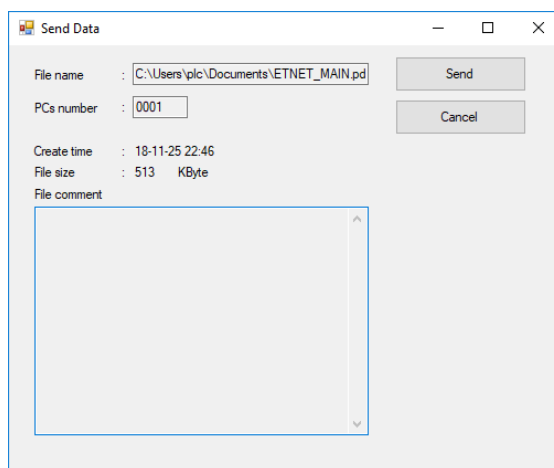

Figure 8-64 Send Data window

When you click **Send**, the Send Data window closes. The system checks the data to be sent, after which data transmission begins.

If you click **Cancel**, data transmission is canceled and the Send Data window closes.

If the check of the data to be sent reveals an error, data transmission is canceled.

- PCs number

If the PCs number in the file differs than that of the destination area, the system displays the following error message. However, if the PCs number in the file is 9999, the data will be sent regardless of the PCs number of the destination area.

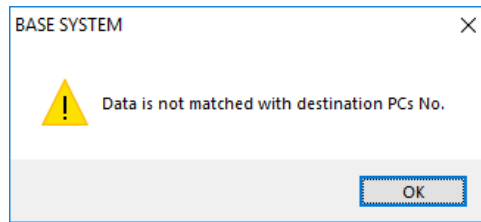

Figure 8-65 Error message displayed when PCs numbers do not match

- Module identification code

If the module type in the file differs than that of the destination area, the system displays the following error message:

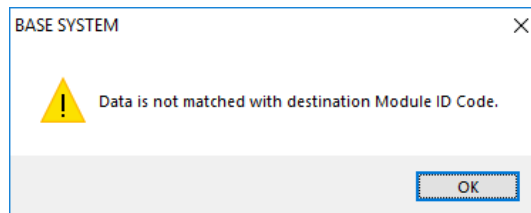

Figure 8-66 Error message displayed when module identification codes do not match

- Module number

If the module number in the file differs than that of the destination area, the system displays the following error message:

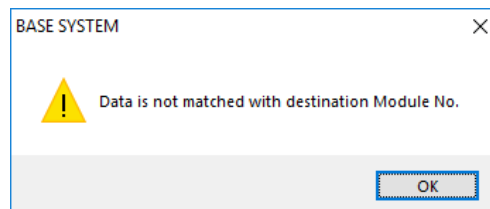

Figure 8-67 Error message displayed when module numbers do not match

- (4) The following window appears displaying the progress of data transmission.

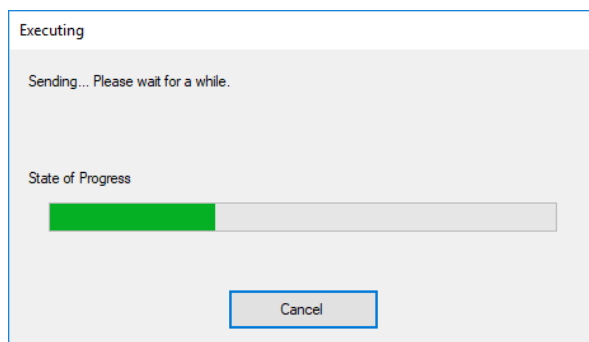

Figure 8-68 Progress window (sending data)

If you click **Cancel**, data transmission is interrupted and the **Cancel** button in the progress window changes to a **Close** button. Towards the end of transmission, you will reach a point where you are no longer able to cancel the data transmission. The **Cancel** button will be unavailable after this time.

- (5) When data transmission has completed, the **Cancel** button in the progress window changes to a **Close** button.
- (6) When data transmission has completed, the system displays a message notifying you that the PCs will be reset, and asking for your confirmation (Figure 8-32).

Click **OK** to reset the PCs.

If you click **Cancel**, the PCs are not reset.

If BASE SYSTEM successfully resets the PCs, it displays a message to that effect (Figure 8-33).

If the reset fails, the system displays a message reporting that the reset was not successful (Figure 8-34).

8.4.3.3.2 Receiving data

Perform the following procedure to download option module settings data to a file:

- (1) Select the area number whose settings you want to receive, and then click **Receive**.
- (2) A Save As window appears. Specify the name of the file where you want to save the data.

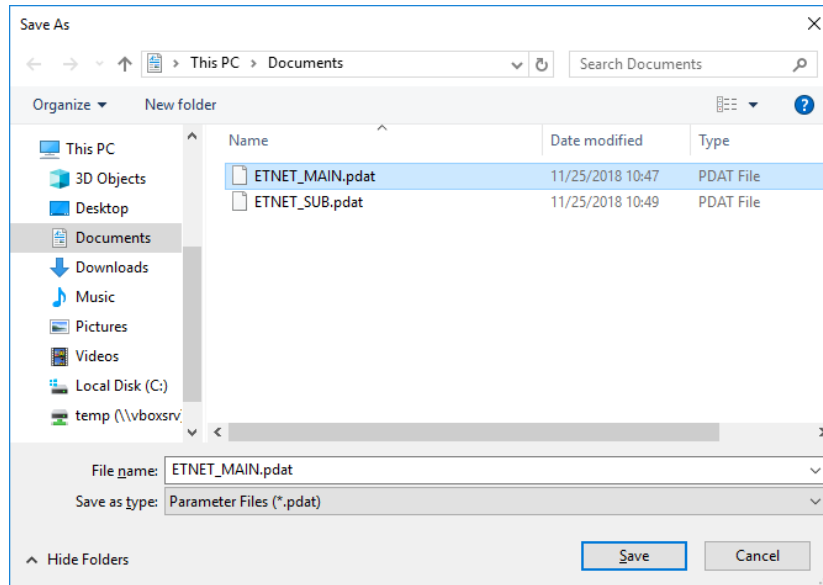

Figure 8-69 Save As window (Data Send/Receive)

When you click **Save**, the Save As window closes and the Receive Data window appears. To close the Save As window, click **Cancel**.

- (3) Make the necessary changes in the Receive Data window, such as changing the PCs number or entering a comment.

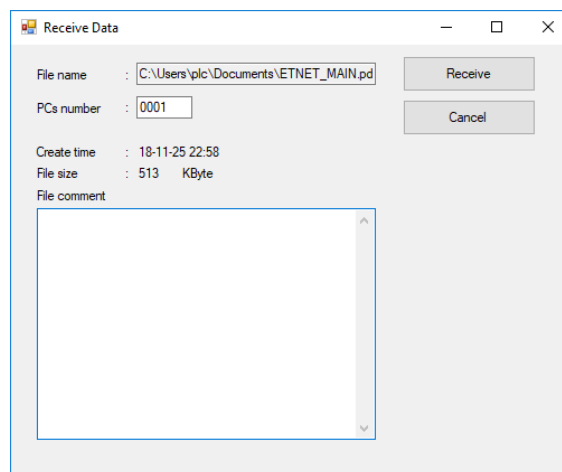

Figure 8-70 Receive Data window

- PCs number

Specify the number that identifies the PCs in a range from 0 to 9999. By default, the PCs number is that of the open project.

You can use the number 9999 as a wildcard. If you use a file saved with the PCs number 9999 when sending data to PCs, the data will be sent without checking the PCs number of the destination area.

- Comment

Specify a comment (maximum 512 characters) that helps identify the file. This field is blank by default.

When you click **Receive**, the Receive Data window closes and the system begins data reception.

If you click **Cancel**, data reception is canceled and the Receive Data window closes.

- (4) The following window appears displaying the progress of data reception:

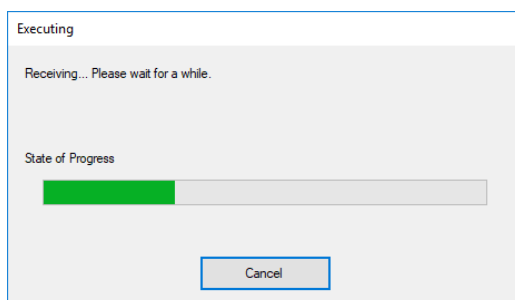

Figure 8-71 Progress window (receiving data)

If you click **Cancel**, data reception is interrupted and the **Cancel** button in the progress window changes to a **Close** button.

- (5) When data reception has completed, the **Cancel** button in the progress window changes to a **Close** button.

8.4.3.3.3 Comparing data

Perform the following procedure to compare the option module settings data in a file with the corresponding data on PCs:

- (1) Select the area number whose settings you want to compare, and then click **Compare**.
- (2) An Open window appears. Select the file that contains the data you want to compare (Figure 8-63).
When you click **Open**, the Open window closes and the Compare Data window appears.
To close the Open window, click **Cancel**.
- (3) Check the file information in the Compare Data window.

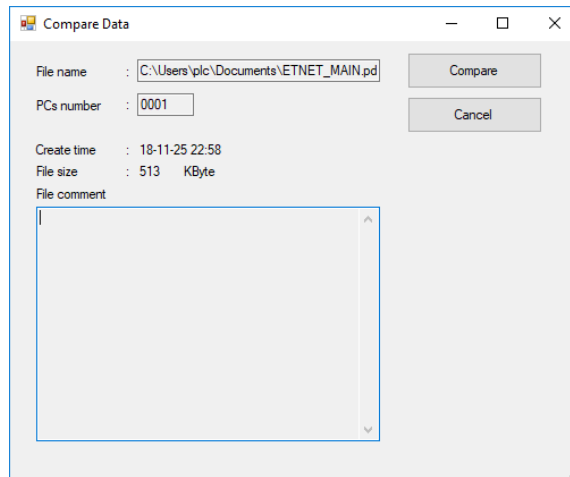

Figure 8-72 Compare Data window

When you click **Compare**, the Compare Data window closes and data comparison begins. If you click **Cancel**, data comparison is canceled and the Compare Data window closes.

- (4) The following window appears displaying the progress of data comparison:

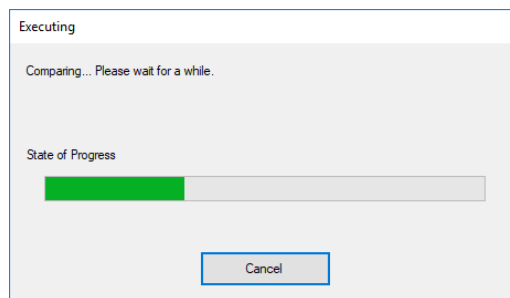

Figure 8-73 Progress window (comparing data)

If you click **Cancel**, data comparison is interrupted and the **Cancel** button in the progress window changes to a **Close** button.

- (5) When data comparison has completed, the **Cancel** button in the progress window changes to a **Close** button.

If the data is consistent, the system displays a message indicating the data comparison was successfully completed (Figure 8-74). If there are differences in the data, the system displays a second format of a message indicating that the data is inconsistent (Figure 8-77). The system also outputs the data that was found to be inconsistent to a comparison error data file (COMPARE_ERROR.txt) (Figure 8-78).

If the data is inconsistent and a comparison error data file already exists, you will be asked if you want to overwrite the existing file (Figure 8-75).

If you click **Yes**, the system overwrites the existing comparison error data file. If you click **No**, the system displays a first format of the message indicating that the data is inconsistent (Figure 8-76) and does not overwrite the file.

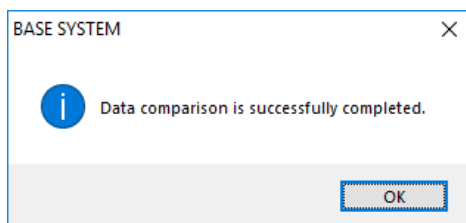

Figure 8-74 Message indicating that comparison was successful

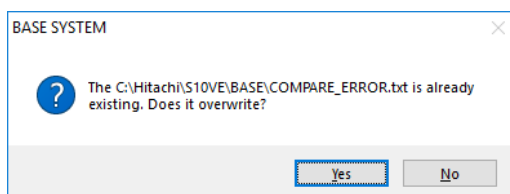

Figure 8-75 Overwrite confirmation message

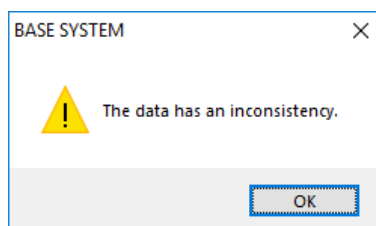

Figure 8-76 Message indicating inconsistent data (first format)

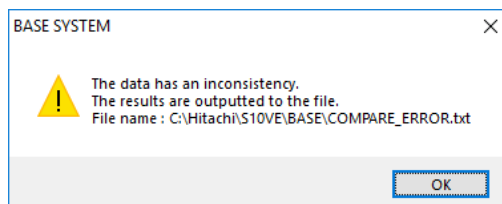

Figure 8-77 Message indicating inconsistent data (second format)

Memory address	M>: Memory data F>: File data
H0010 0000	M> 1234ABCD 0001000 00000034 00000000 F> 1234ABCD 0002000 00001F00 00000000
H0010 0100	M> 00000001 FFFFFFF0 00000000 00000000 F> C0A8FA01 FFFFFFF0 00000000 00000000

Figure 8-78 Format of comparison error data file

Explanation of comparison error data file format

Data is compared in units of four longwords. If the system detects an inconsistency in one of these units, it outputs the memory address, memory data, and file data to the comparison data file.

Memory address: The starting address of the four longwords of data the system had read when it detected the inconsistent data.

Memory data: The four longwords of data that were read, starting from the memory address on the PCs.

File data: The four longwords of data in the comparison data file, starting from an offset corresponding to the memory address.

- (6) Click **Close** to close the Data Send/Receive window.

8.4.3.3.4 Deleting data

Perform the following procedure to delete option module settings data from the PCs.

Note that this function deletes option module settings from the CPU module, not from the option module itself. The option module concerned will continue to operate until removed.

- (1) Select the area number whose settings you want to delete, and then click **Delete**.
- (2) A message appears asking you to confirm that you want to delete the data (Figure 8-79).
Click **OK** to delete the data.
If you click **Cancel**, the data is not deleted.

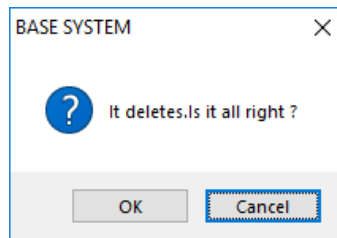

Figure 8-79 Data deletion confirmation message

8.4.3.4 Online menu: Backup, Restore, Backup save data comparison

Use these menu items to back up and restore data on PCs, and to compare backup data against the data on the PCs.

For details about each of these functions, see 8.5 *BACKUP RESTORE SYSTEM*.

8.4.3.5 Online menu: Remote Reset

Use this menu item to reset PCs.

Exercise caution when using the remote reset function. This function can reset PCs even if it is running a ladder program.

- (1) From the main menu, select **Online** and then **Remote Reset**.
- (2) A message appears asking you to confirm that you want to reset the PCs.

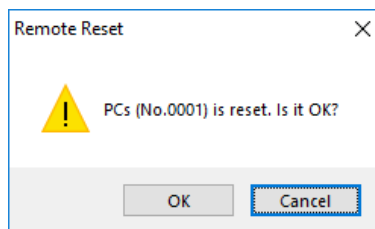

Figure 8-80 Remote reset confirmation message

To reset the PCs, click **OK**.

If you do not want to reset the PCs, click **Cancel**.

- (3) If BASE SYSTEM successfully resets the PCs, it displays a message to that effect (Figure 8-33). If the reset fails, BASE SYSTEM displays a message reporting that the reset was not successful (Figure 8-34).

8.4.3.6 Online menu: Remote Restart

Use this menu item to restart stopped PCs in RUN mode.

Confirm the following before performing a remote restart:

- The PADT is not connected to an ET.NET module.

You can remotely restart a CPU module whose CPU RUN/STOP switch is set to STOP. However, the CPU module will not restart in RUN mode. The CPU module will enter RUN mode when you switch its CPU RUN/STOP switch to RUN.

- (1) From the main menu, select **Online** and then **Remote Restart**.

You cannot perform a remote restart if the communication type is ET.NET. If you attempt to do so, an error message appears indicating that the function cannot be used when BASE SYSTEM is connected to an ET.NET module (Figure 8-50).

- (2) A message appears asking you to confirm that you want to restart the PCs. To restart the CPU module, click **OK**.

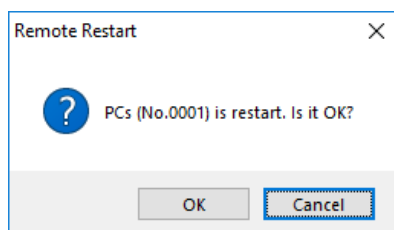

Figure 8-81 Remote restart confirmation message

- (3) The system restarts the CPU module. If the restart is successful, the system displays a message to that effect. Click **OK** to dismiss the message. You are returned to the BASE SYSTEM main window (Figure 8-14).

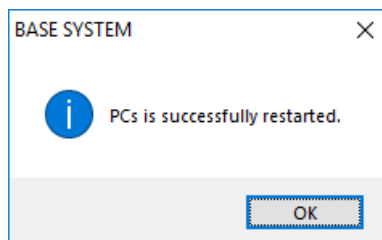

Figure 8-82 Restart successful message

If the restart fails, the system displays a message reporting that the restart was not successful. Click **OK** to dismiss the message. In this case, you will need to restart the CPU module by turning it off and then on again.

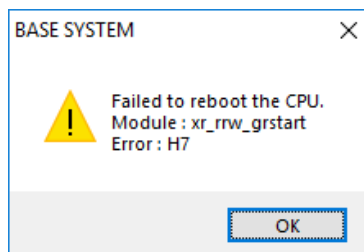

Figure 8-83 Restart failed message

8.4.3.7 Online menu: Data Clear

Use this menu item to clear the backup memory of the PCs.

The backup memory is the area from H00480600 to H04FF1FFF. The following table lists the area cleared by the data clear function:

Table 8-4 Data clear area

No.	Address	Description
1	H00480600 to H004807FF	C-count value
2	H00481000 to H004811FF	Keep relay (KW000 to KWFF0)
3	H00481700 to H0048171F	Up/Down counter (CW000 to CW0F0)
4	H00482000 to H004837FF	Work register (FW000 to FWBFF)
5	H00483800 to H00483FFF	Long word register (BD000 to BD1FE)
6	H00490000 to H00497FFF	Long word register (LML0000 to LML1FFF)
7	H00498000 to H0049FFFF	Floating-point register (LG0000 to LG1FFF)
8	H004A0000 to H004A7FFF	Word register (LXW0000 to LXW3FFF)
9	H004F0000 to H004F1FFF	Data register (DW000 to DWFFF)

- (1) From the main menu, select **Online** and then **Data Clear**.
- (2) A message appears asking you to confirm that you want to clear the backup memory.

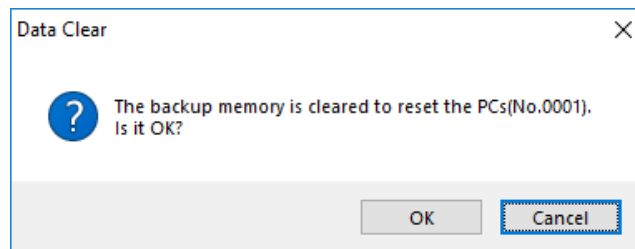

Figure 8-84 Data clear confirmation message

Click **OK** to clear the backup memory.

If you do not want to clear the backup memory, click **Cancel**.

- (3) If a communication line error occurs during the memory clear operation, the system displays a message indicating that an error was detected (Figure 8-85).
Check the communication line between the PADT and PCs, and then initiate the data clear operation again.

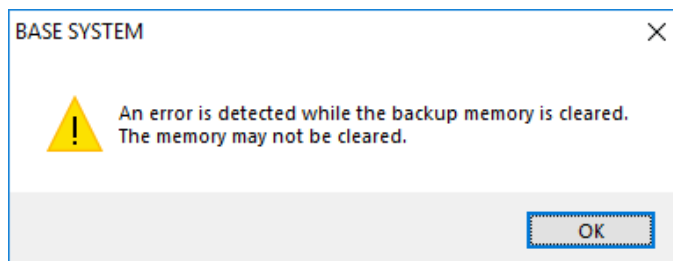

Figure 8-85 Error detected message

- (4) If BASE SYSTEM successfully resets the backup memory, it displays a message to that effect (Figure 8-33).
If the reset fails, the system displays a message reporting that the reset was not successful (Figure 8-34).

8. Tools

8.4.4 Program functions

Program functions are available from the **Program** menu.

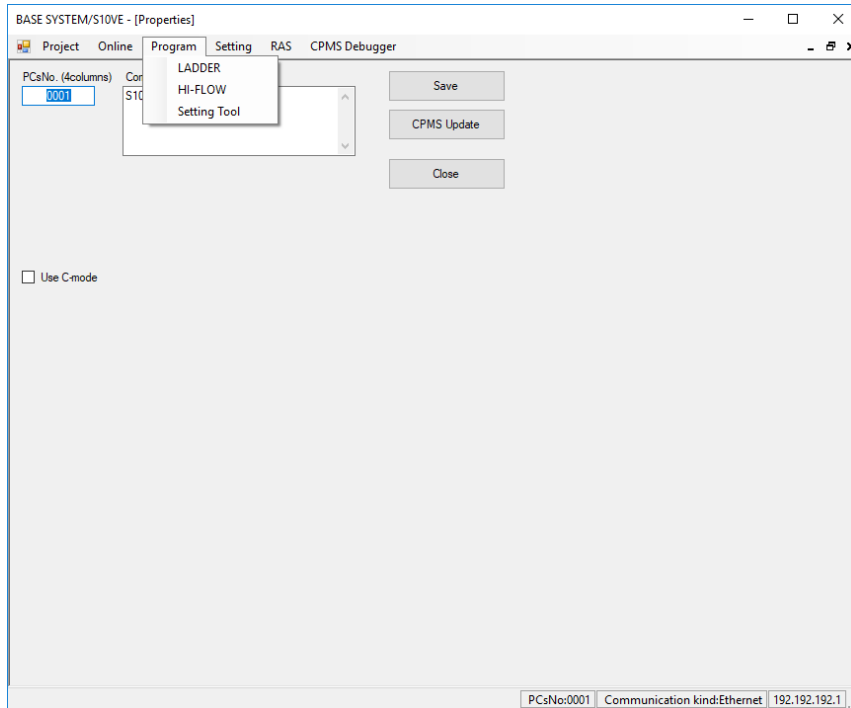

Figure 8-86 Window after clicking the Program menu

The following table lists and describes the program functions:

Table 8-5 List of Program menu items

No.	Category			Description
	Level 1	Level 2	Level 3	
1	Program	LADDER	--	Starts LADDER DIAGRAM SYSTEM.
2		HI-FLOW	--	Starts HI-FLOW SYSTEM.
3		Setting Tool	--	Displays a list of tools. You can display the setup window for a tool by selecting it from the list.

8.4.4.1 Program menu: LADDER

Use this menu item to start LADDER DIAGRAM SYSTEM.

- (1) From the main menu, select **Program** and then **LADDER**.
- (2) LADDER DIAGRAM SYSTEM starts.

8.4.4.2 Program menu: HI-FLOW

Use this menu item to start HI-FLOW SYSTEM.

- (1) From the main menu, select **Program** and then **HI-FLOW**.
- (2) HI-FLOW SYSTEM starts.

8.4.4.3 Program menu: Setting Tool

Use this menu item to display a list of tools installed on the PADT. You can display the setup window for a tool by selecting it from the list of option module tools.

- (1) From the main menu, select **Program** and then **Setting Tool**.
- (2) The Setting Tool window appears.

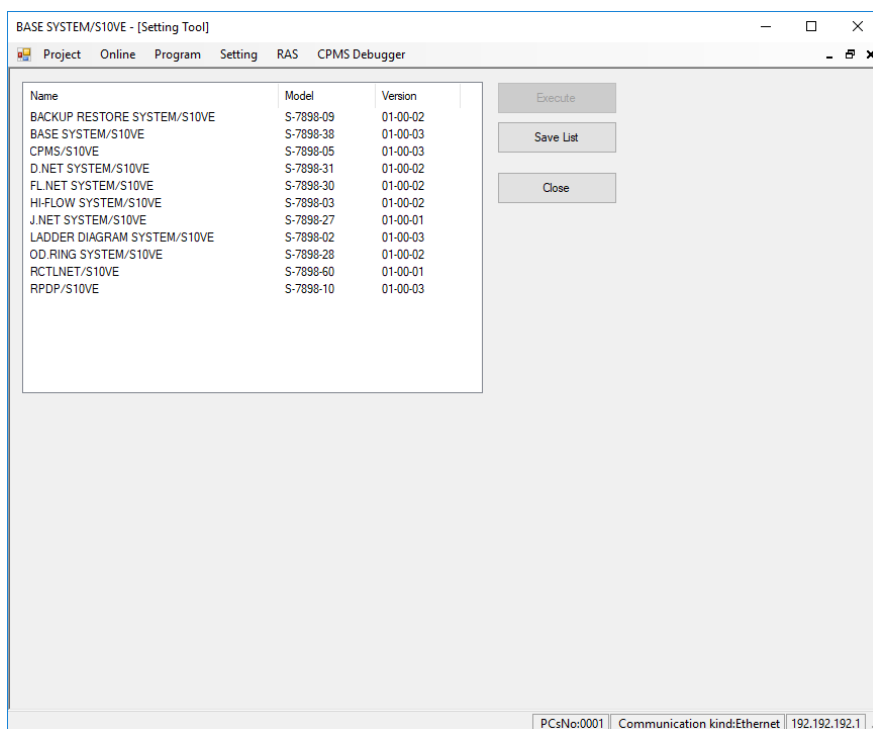

Figure 8-87 Setting Tool window

8. Tools

- (3) The system display a list of tools installed on the PADT.
The following table explains the items displayed in the list:

Table 8-6 Items displayed in Setting Tool window

No.	Item	Description
1	Name	The name of the tool installed on the PADT.
2	Model	The type of the tool installed on the PADT.
3	Version	The version number of the tool installed on the PADT.

- (4) Select the tool that you want to start from the list, and then click **Execute**.
The main setup window for the configuration tool appears.
If the system is unable to start the tool, the following error message appears:

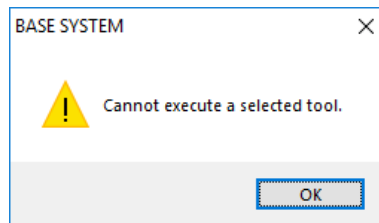

Figure 8-88 Error message displayed when selected tool cannot be run

- (5) To save the contents of the list to a text file, click the **Save List** button. A Save As window appears.
When you click **Save** in the Save As window, the system saves the contents of the list to a text file with a default file name of PPList.txt. You can save the file under a different name by changing the contents of the **File name** field before clicking **Save**.
- (6) Click **Close** to close the Setting Tool window.

8.4.5 Setting functions

Setting functions are available from the **Setting** menu.

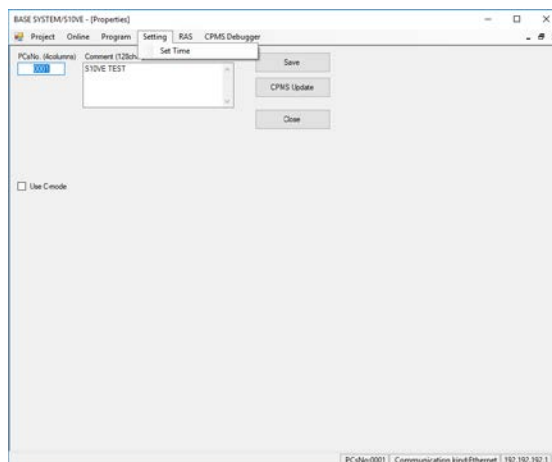

Figure 8-89 Window after clicking the Setting menu

The following table lists and describes the setting functions:

Table 8-7 List of Setting menu items

No.	Category			Description
	Level 1	Level 2	Level 3	
1	Setting	Set Time	--	Shows or sets the clock of the CPU module.

8.4.5.1 Setting menu: Set Time

Use this menu item to display or set the clock of the CPU module.

- (1) From the main menu, select **Setting** and then **Set Time**.
- (2) The Set Time window appears. By default, the system retrieves and displays the time from the CPU module.

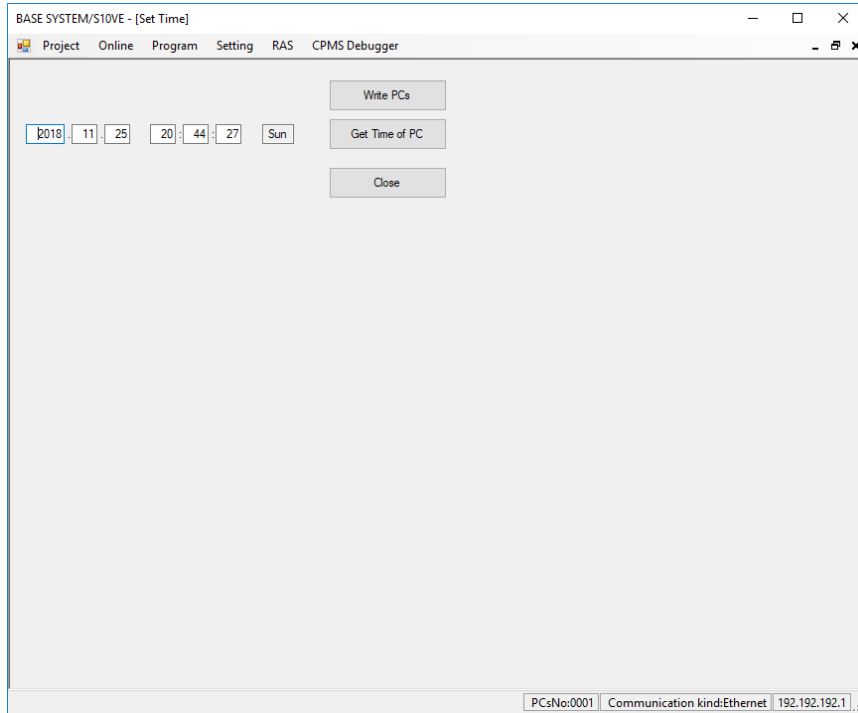

Figure 8-90 Set Time window

- (3) If you want to change the time displayed in the Set Time window, enter the new time in the fields provided. You can input the time setting of the PADT by clicking the **Get Time of PC** button.
- (4) To update the CPU module with the new time setting, click **Write PCs**.
- (5) Click **Close** to close the Set Time window.

8.4.6 RAS functions

RAS functions are available from the **RAS** menu.

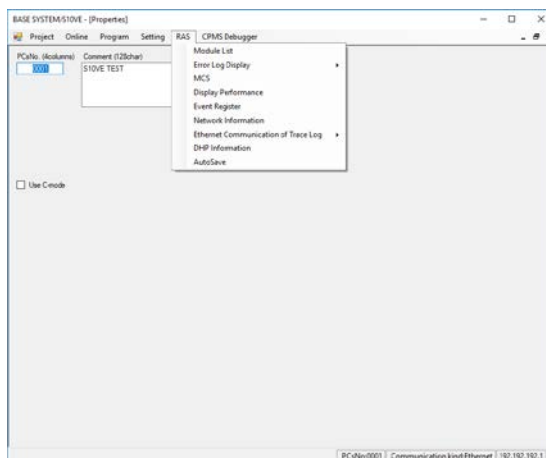

Figure 8-91 Window after clicking the RAS menu

The following table lists and describes the RAS functions:

Table 8-8 List of RAS menu items

No.	Category			Description
	Level 1	Level 2	Level 3	
1	RAS	Module List	--	Displays information about installed modules.
2		Error Log Display	CP Error log Display	Displays log information for errors that occur on the PCs.
3			HP Error log Display	
4		MCS	--	Displays the MCS window. MCS (Man-machine Communication System) is a collective term for the functions that support writing to and reading from PCs memory.
5		Display Performance	--	Displays the sequence cycles and the CP/HP load ratio.
6		Event Register	--	Displays the ON/OFF state of the event register.
7		Network Information	--	Displays network information.
8		Ethernet Communication of Trace Log	LADDER	Displays the Ethernet communication logs for ladder logic.
9			Socket Handler	Displays the Ethernet communication logs for the socket handler.
10		DHP Information	--	Displays a window in which you can set the DHP recording mode and view DHP trace information.
11		AutoSave	--	Outputs an autosave file and fault analysis information file.

8. Tools

8.4.6.1 RAS menu: Module List

Use this menu item to display a list of modules and microprograms installed in the system.

- (1) From the main menu, select **RAS** and then **Module List**.
- (2) The Module List window appears.

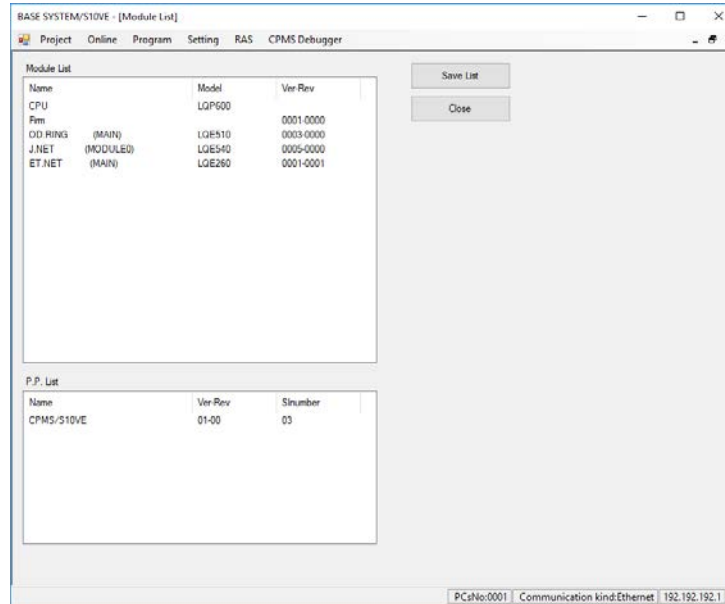

Figure 8-92 Module List window

- (3) The Module List window displays the version and revision number of the CPMS and firmware (Firm). It also displays information about the option modules, and version information for the tools on the CP side. The following table explains the items displayed in the Module List window:

Table 8-9 Items in Module List window

No.	Area	No.	Item	Description
1	Module List	1	Name	The name of the CPMS, firmware, or installed module.
		2	Model	The model number of the installed module.
		3	Ver-Rev	The version and revision number of the microprogram installed on the module, in the format <i>version-number-revision-number</i> .
2	P.P. List	1	Name	The name of the tool registered on the PCs.
		2	Ver-Rev	The version and revision number of the tool registered on the PCs.
		3	SI number	The SI number of the tool registered on the PCs.

- (4) To save the contents of the list to a text file, click the **Save List** button.
- (5) Click **Close** to close the Module List window.

8.4.6.2 RAS menu: Error Log Display

Use this menu item to display log information related to errors that occurred on the PCs. A maximum of two fatal errors and 32 nonfatal errors are displayed.

- (1) To display error log information for the ET.NET module or for the CP side of the CPU module, from the main menu, select **RAS, Error Log Display**, and then **CP Error Log Display**.

To display error log information for the HP side, from the main menu, select **RAS, Error Log Display**, and then **HP Error Log Display**.

- (2) The Display Error log CP or Display Error log HP window appears.

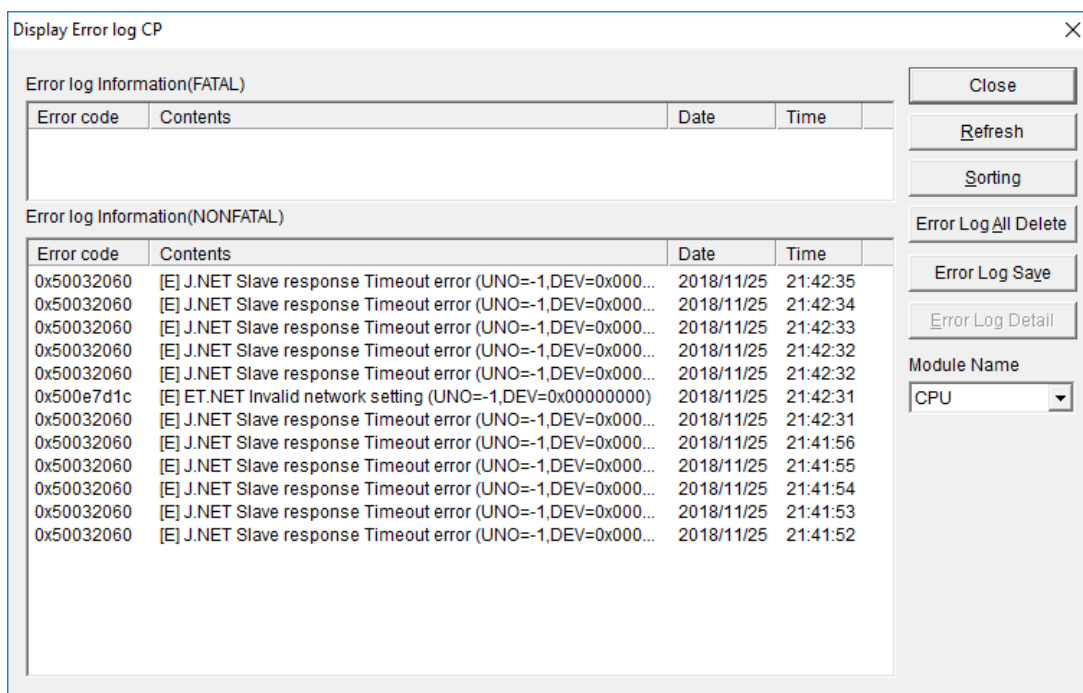

Figure 8-93 Display Error log CP window

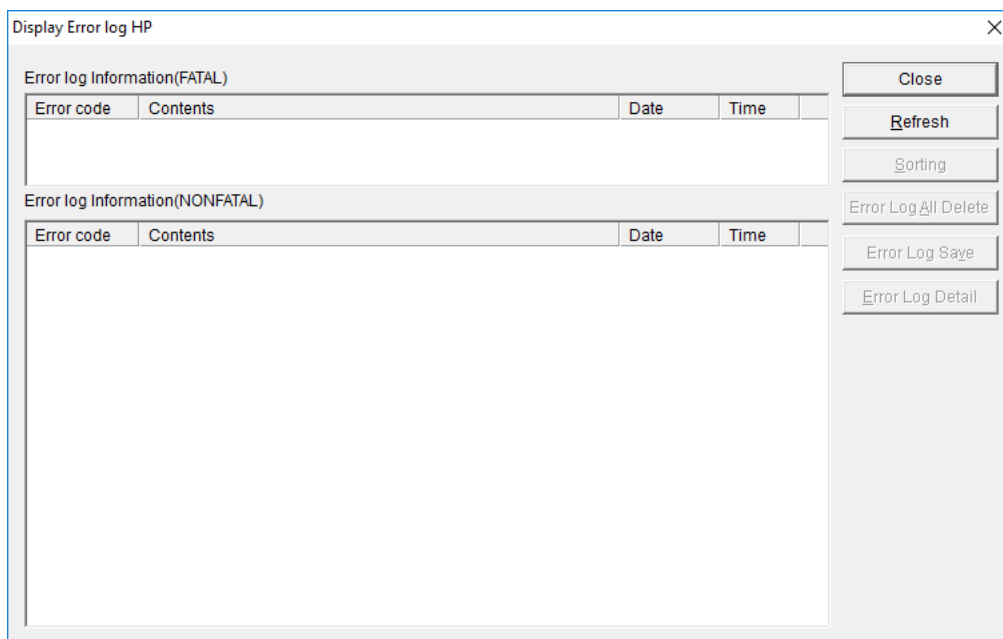

Figure 8-94 Display Error log HP window

- (3) In the Display Error log CP window, you can select whether to display error information for the CPU module or for an ET.NET module.
The Display Error log HP window only displays error information for the CPU module.

Table 8-10 Module names that can be selected in Display Error log CP window

No.	Item	Description
1	CPU	Error log information for the CPU module (default).
2	ET.NET(MAIN)	Error log information for the ET.NET main module.
3	ET.NET(SUB)	Error log information for the ET.NET sub-module.

- (4) The following table explains the items that appear in the Display Error log CP window and the Display Error log HP window:

Table 8-11 Items displayed in Display Error log CP and HP windows

No.	Item	Description
1	Error code	The error code.
2	Contents	The information the error code represents.
3	Date	The date on which the error occurred.
4	Time	The time at which the error occurred.

For details about the error codes associated with the ET.NET module, see *13.2.2.5 ET.NET module troubleshooting*.

The information the error code represents is output in the following format:

Panic log:

[*]	*****	(PC=*****)	(FADR=*****)
(1)	(2)	(3)	(4)

- (1) Error severity type
 - [F]: Fatal error
 - [FU]: Built-in subroutine error
- (2) Error message
- (3) Program counter
- (4) Fault address

Non-panic logs:

First pattern:

[*]	*****	(UNO=**, DEV=*****)	(TN=***)	(SLOT=**)
(1)	(2)	(3)	(4)	(5)

- (1) Error severity type
 - [F]: Fatal error [W]: Warning
 - [E]: Error [I]: Information
- (2) Error message
- (3) Unit number, device number
 - Range of unit numbers: 1 to 24
 - Range of device numbers: 0x00000000 to 0xFFFFFFFF
- (4) Task number
 - Range of task numbers: 1 to 300
- (5) Slot number
 - Range of slot numbers: 0 to 7

Note: In the first pattern for non-panic logs, the information in (3) to (5) is not output for some error types.

Second pattern:

```
%****_*_****_****  
(1) (2) (3) (4)
```

- (1) The system that detected the error.
 - CPMS: CPMS (basic OS)
 - LNET: RCTLNET (network driver)
 - NX: NXACP (autonomous distributed platform)
 - MSxx: Middleware (where xx is a number from 01 to 16)
 - USxx: Application software (where xx is a number from 01 to 16)
- (2) Error severity type
 - F: Fatal error E: Error
 - W: Warning I: Information
 - ?: Other
- (3) Fault type
 - HARD: Hardware
 - CPMS: CPMS
 - SOFT: Software other than CPMS
- (4) Code
 - A code representing the type of error log, as a four-digit hexadecimal number.

- (5) To display detailed error information, click **Error Log Detail** to display the Error Log Detail window.
- (6) To display the latest error information, click **Refresh**.
- (7) To sort error information in ascending or descending order of when the error occurred, click **Sorting**. Each time you click **Sorting**, the list switches between ascending and descending order of occurrence time and error log number.
- (8) To delete the error log information for all modules, click **Error Log All Delete**.
- (9) To save the error log information to a text file, click **Error Log Save**.
- (10) Click **Close** to close the Display Error log CP window or Display Error log HP window.

8.4.6.3 Displaying error log details

- (1) In the Display Error log CP window or Display Error log HP window, click **Error Log Detail**.
- (2) The Error Log Detail window appears.

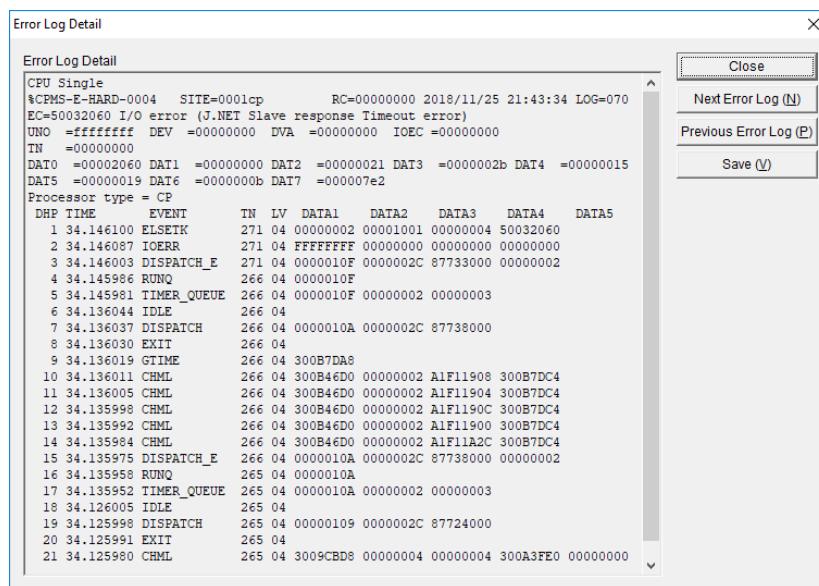
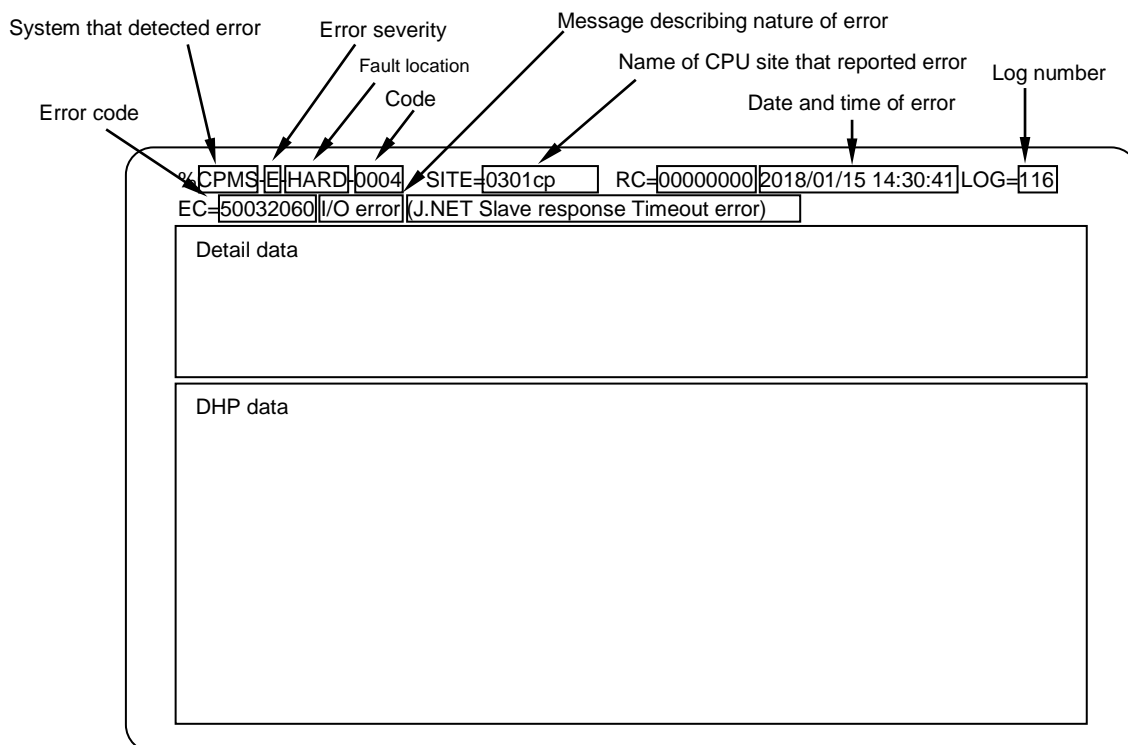

Figure 8-95 Error Log Detail window

- (3) The following shows the items displayed in the Error Log Detail window. For an explanation of the information displayed as detail data, see 8.4.6.2 RAS menu: Error Log Display. For further information about DHP data, see 8.4.6.9 RAS menu: DHP Information.



8. Tools

■ System that detected error

CPMS: CPMS (basic OS)

LNET: RCTLNET (network driver)

NX: NXACP (autonomous distributed platform)

MS xx : Middleware (where xx is a number from 01 to 16)

US xx : Application software (where xx is a number from 01 to 16)

■ Message describing nature of error

Program error: An error in program execution.

Macro parameter check error: An error in a parameter of an OS macro instruction

WDT timeout error: A timeout error triggered by WDT (WatchDog Timer) monitoring

I/O error: An error related to input/output operations

Module error: Primarily hardware errors

For details about other error types, see the documentation for each module.

■ Error severity

F: Fatal Error

E: Error

W: Warning

I: Information

■ Fault location

HARD: Hardware

CPMS: CPMS

SOFT: Software other than CPMS

■ Code

A code that represents the error log type.

- (4) Click **Next Error Log** to display the next page.
- (5) Click **Previous Error Log** to display the previous page.
- (6) To save the detailed error log information displayed in the Error Log Detail window to a text file, click **Save**.
- (7) Click **Close** to close the Error Log Detail window.

8.4.6.4 RAS menu: MCS

Use this menu item to display the MCS window.

- (1) From the main menu, select **RAS** and then **MCS**.
- (2) The MCS window appears.

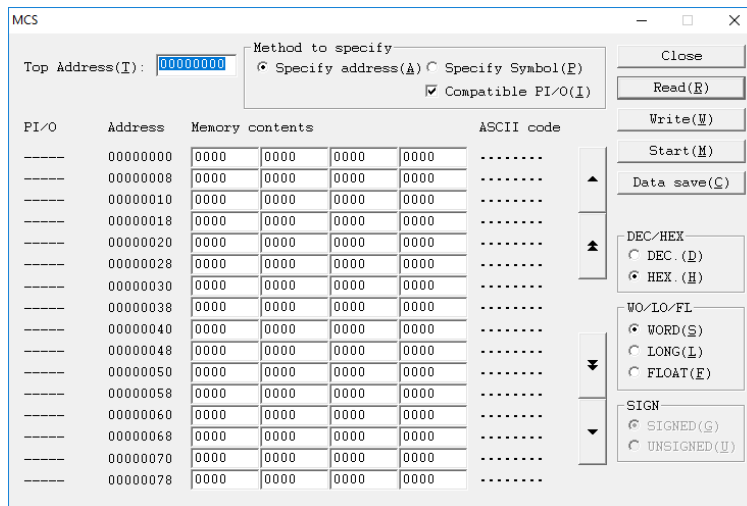

Figure 8-96 MCS window

- (3) In the **Top Address** text box, enter the starting address of the memory whose contents you want to display. In the **Method to specify** group box, select **Specify address** or **Specify Symbol** as the method of specifying the address. If you select the **Compatible PI/O** check box, the register address changes to an S10mini-compatible address or an S10V/S10VE extended address. PI/O names in the register are displayed as both S10mini-compatible addresses and S10VE extended addresses regardless of whether the **Compatible PI/O** check box is selected.
Example: The address of the J000 register is displayed as 0x202000 when the check box is cleared, and 0xA2000 when the check box is selected.
- (4) Click **Read** to read the contents of the displayed addresses from the PCs.
- (5) Click **Write** to write the contents of the displayed addresses to the PCs. If ladder logic is in RUN mode, a message appears asking you to confirm that you want to rewrite the PCs in RUN mode.

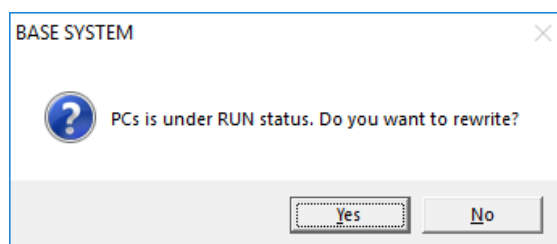

Figure 8-97 Rewrite memory in RUN mode confirmation message

Click **Yes** to write the memory contents to the PCs.

If you click **No**, the memory contents are not written to the PCs.

8. Tools

- (6) To monitor the memory contents at the displayed addresses, click **Start**. The system begins to monitor the memory contents, and the **Start** button changes to a **Stop** button.
- (7) To stop monitoring, click **Stop**. The system stops monitoring the memory contents, and the **Stop** button changes to a **Start** button.
- (8) To save the window contents to a text file, click the **Data save** button.
- (9) In the **DEC/HEX** group box, select decimal (**DEC**) or hexadecimal (**HEX**) as the display format of the memory contents. The default is **HEX**.
DEC: The memory contents are displayed as decimal values. You must input a decimal value when changing a value in memory.
HEX: The memory contents are displayed as hexadecimal values. You must input a hexadecimal value when changing a value in memory.
- (10) In the **WO/LO/FL** group box, select the data type to use when displaying memory contents. The default is **WORD**.
WORD: Data is displayed as 2-byte integers.
LONG: Data is displayed as 4-byte integers.
FLOAT: Data is displayed as floating point data.
- (11) In the **SIGN** group box, select whether to display data using signed or unsigned integers. The default is **SIGNED**. This group box is only available when **DEC** is selected in **DEC/HEX** and **WORD** or **LONG** is selected in **WO/LO/FL**.
SIGNED: Data is displayed using signed integers.
UNSIGNED: Data is displayed using unsigned integers.
- (12) Click **Close** to close the MCS window.

8.4.6.5 RAS menu: Display Performance

Use this menu item to display the CP and HP load factors.

- (1) From the main menu, select **RAS** and then **Display Performance**.
- (2) The Performance window appears.

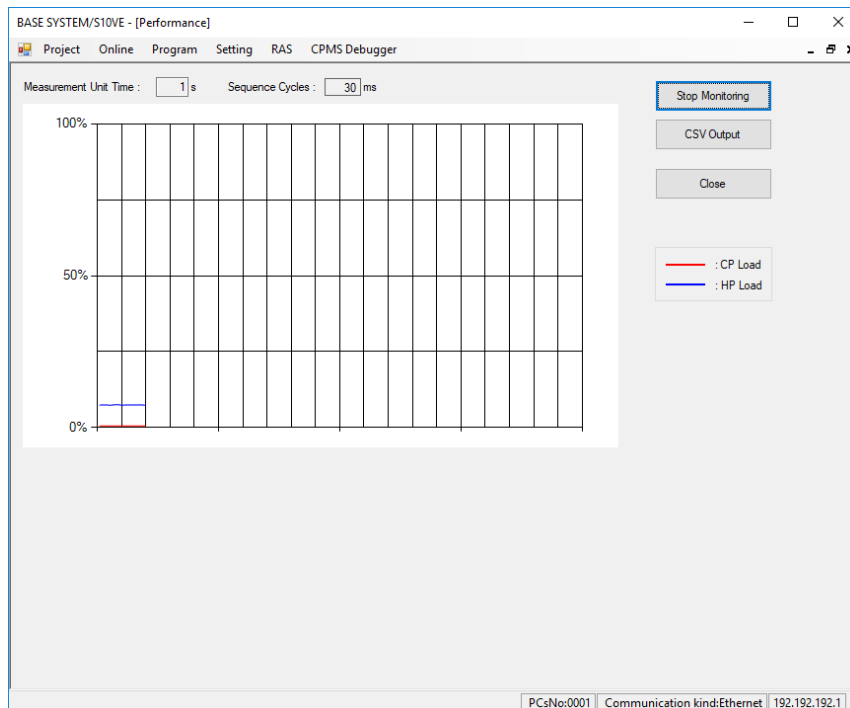

Figure 8-98 Performance window

- (3) In the **Measurement Unit Time** field, specify the measurement cycle of the load factor. Specify 1 or a multiple of the sequence cycle (maximum of 100), in seconds.
- (4) To start performance monitoring, click **Start Monitoring**. Performance monitoring starts and the button changes to **Stop Monitoring**.
During monitoring, the Performance window displays the CP and HP load ratios as a graph.
- (5) To stop performance monitoring, click **Stop Monitoring**. Performance monitoring stops and the button changes to **Start Monitoring**.
- (6) To save the information gathered by the performance monitoring function to a file in CSV format, click **CSV Output**.
- (7) Click **Close** to close the Performance window.

Do not switch the CPU switch between STOP and RUN modes repeatedly while the performance function is monitoring the CPU load factor during operation. If you switch between STOP and RUN modes in this way during monitoring, the performance function might record abnormal CPU load factor values.

8. Tools

The format of the CSV file is as follows:

```
CP , HP
XXXXXXXXXX , YYYYYYYYYY
XXXXXXXXXX , YYYYYYYYYY
XXXXXXXXXX , YYYYYYYYYY
      :
XXXXXXXXXX , YYYYYYYYYY
```

XXXXXXXXXXXX: CP side load factor (expressed as floating point numeral from 0 to 100%)

YYYYYYYYYYY: HP side load factor (expressed as floating point numeral from 0 to 100%)

8.4.6.6 RAS menu: Event Register

Use this menu item to display the ON/OFF state of event registers (E coil) E0000 to E01FF.

- (1) From the main menu, select **RAS** and then **Event Register**.
- (2) The Event Register Monitor window appears.

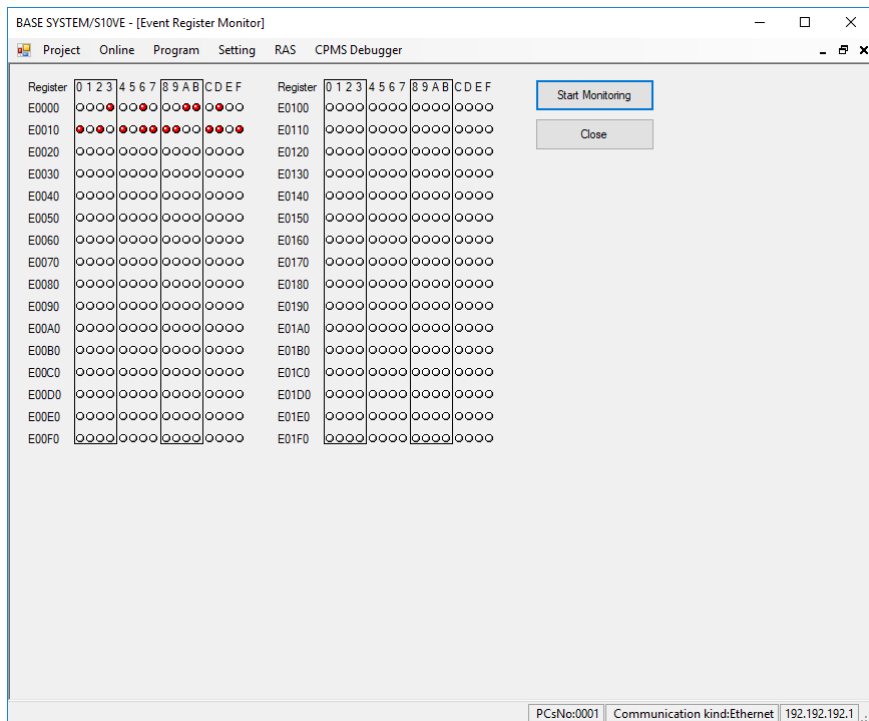

Figure 8-99 Event Register Monitor window

- (3) Click **Start Monitoring** to start monitoring the event registers. Event register monitoring starts and the button changes to **Stop Monitoring**.
During monitoring, the on-screen elements in the Event Register Monitor window change colors to reflect the state of the corresponding bit.
 - When the bit is OFF: The corresponding element is displayed in white.
 - When the bit is ON: The corresponding element is displayed in red.
- (4) To stop monitoring the event registers, click **Stop Monitoring**. Event register monitoring stops and the button changes to **Start Monitoring**.
- (5) Click **Close** to close the Event Register Monitor window.

8.4.6.7 RAS menu: Network Information

Use this menu item to display the network information of the CPU module and ET.NET module.

- (1) From the main menu, select **RAS** and then **Network Information**.
- (2) The Display Status of Network window appears.

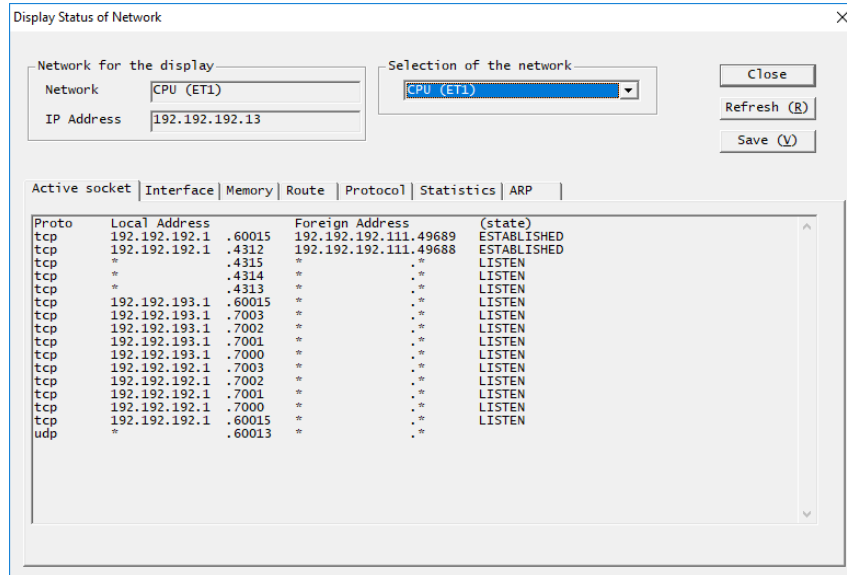

Figure 8-100 Display Status of Network window

- (3) Select the network whose network information you want to display from the **Selection of the network** drop-down list.

Table 8-12 Items in Selection of the network drop-down list

No.	Network name	Remarks
1	CPU (ET1)	
2	CPU (ET2)	
3	ET.NET(MAIN) (CH1)	Does not appear if no ET.NET main module is installed.
4	ET.NET(MAIN) (CH2)	Does not appear if no ET.NET main module is installed.
5	ET.NET(SUB) (CH1)	Does not appear if no ET.NET sub-module is installed.
6	ET.NET(SUB) (CH2)	Does not appear if no ET.NET sub-module is installed.

- (4) Select the particular aspect of network information that you want to display by clicking the applicable tab.

The Display Status of Network window contains the following tabbed pages:

Table 8-13 Tabbed pages in Display Status of Network window

No.	Item	Description
1	Active socket	Displays socket information.
2	Interface	Displays current information about the network interfaces.
3	Memory	Displays management information for the send/receive buffer.
4	Route	Displays routing information.
5	Protocol	Displays statistical information related to the IP protocol.
6		Displays statistical information related to the ICMP protocol.
7		Displays statistical information related to the TCP protocol.
8		Displays statistical information related to the UDP protocol.
9	Statistics	Displays statistical information about the interfaces.
10	ARP	Displays ARP table information.

- (5) Click **Refresh** to display network information in the category you selected.
- (6) To save the displayed network information to a text file, click **Save**. In the Save As window that appears, select a folder and specify a file name.

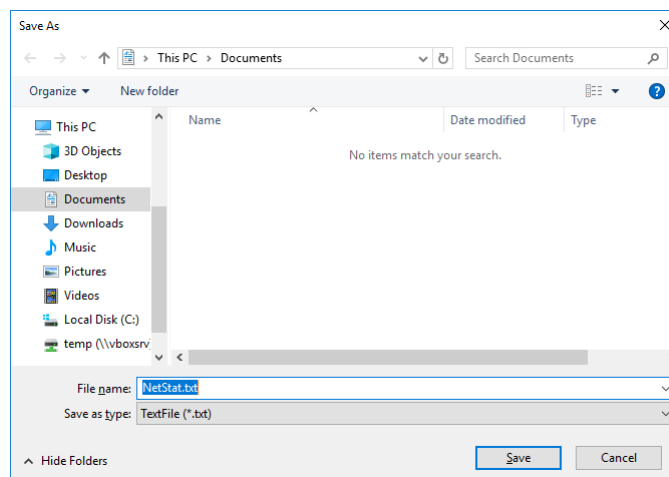

Figure 8-101 Save As window

After selecting a folder and specifying a file name, click **Save**. The network information is saved to the file you specified.

- (7) Click **Close** to close the Display Status of Network window.

8.4.6.8 RAS menu: Ethernet Communication of Trace Log

Use this menu item to display the Ethernet communication trace logs for the CPU module and ET.NET module.

- (1) To display the contents of the Ethernet communication trace log, select **RAS, Ethernet Communication of Trace Log**, and then **LADDER** or **Socket handler**.

There are two screens that display the information in the error trace log. One displays the error trace log information for ladder logic, and the other for the socket handler.

- (2) The Display Ethernet Communication of Trace Log (LADDER) window appears.

• Ethernet communication trace log (LADDER)

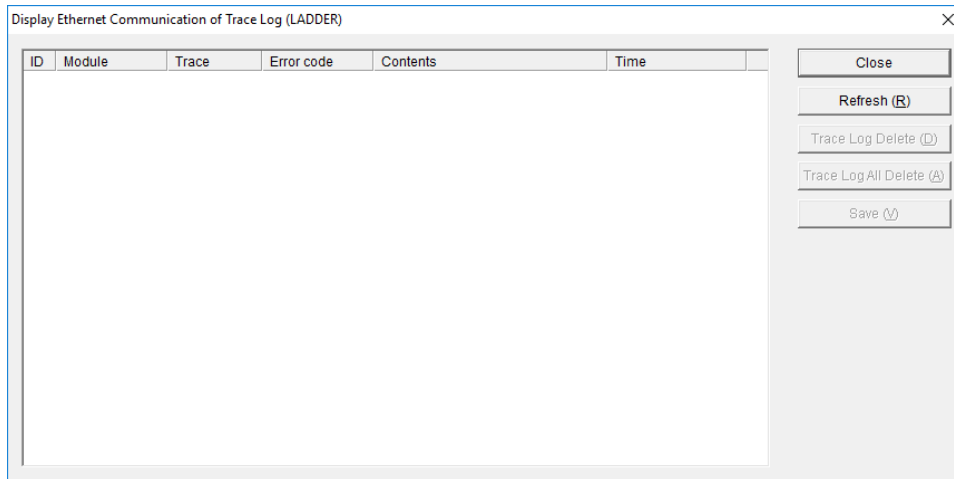

Figure 8-102 Display Ethernet Communication of Trace Log (LADDER) window

Function: This window displays trace log information for errors that occur in relation to ladder Ethernet communication. The contents of this trace information is as follows:

Table 8-14 Information in Ethernet communication trace log (LADDER)

No.	Item	Displayed information
1	ID	The management table number for ladder Ethernet communication.
2	Module	The module name.
3	Trace	The trace code of the trace information.
4	Error code	The error code of the error.
5	Contents	The contents of the error code of the error
6	Time	The time when the error occurred.

For details on traces, see *Appendix F. List of DHP Codes* in the *SIOVE Software Manual CPMS General Description and Macro Specifications* (manual number SEE-3-201).

For details on error codes, see the list of detailed result codes in *2.7.2 Usage* in the *SIOVE Software Manual Programming Ladder Diagram System for Windows®* (manual number SEE-3-121).

- Ethernet communication trace log (socket handler)

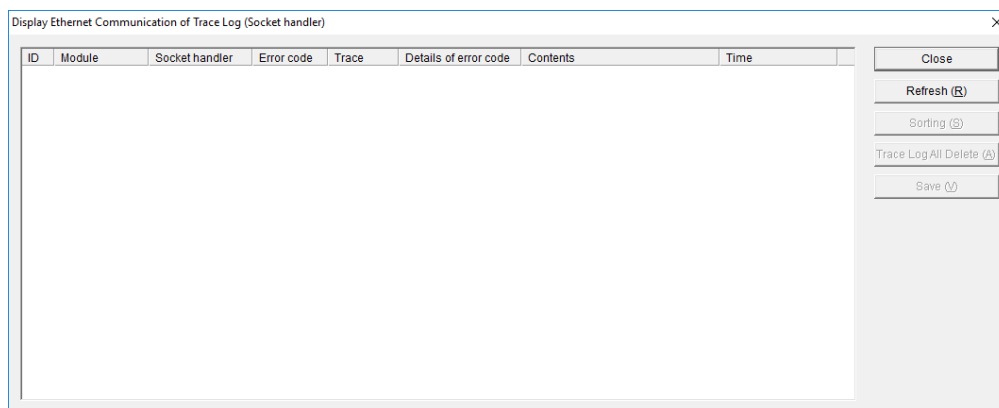

Figure 8-103 Display Ethernet Communication of Trace Log (Socket handler) window

Function: This window displays trace log information for socket handler errors that occur in relation to socket handler Ethernet communication. The contents of this trace information is as follows:

Table 8-15 Information in Ethernet communication trace log (socket handler)

No.	Item	Displayed information
1	ID	The socket ID of the socket handler.
2	Module	The module name.
3	Socket handler	The name of the socket handler.
4	Error code	The error code of the error.
5	Trace	The location where the error was detected.
6	Details of error code	The detailed error code output when the error was detected.
7	Contents	The contents of the error code of the error.
8	Time	The time when the error occurred.

For details on traces, see *Appendix F. List of DHP Codes* in the *SIOVE Software Manual CPMS General Description and Macro Specifications* (manual number SEE-3-201).

For details on error codes, see the list of detailed result codes in *2.7.2 Usage* in the *SIOVE Software Manual Programming Ladder Diagram System for Windows®* (manual number SEE-3-121).

- (3) To display the latest information in the Ethernet communication trace log, click **Refresh**.
- (4) To delete the Ethernet communication trace log information associated with the specified ID, click **Trace Log Delete**. To delete all Ethernet communication trace log information, click **Trace Log All Delete**.

8. Tools

- (5) To save the displayed Ethernet communication trace log information to a text file, click **Save**. Select a folder and specify a file name in the Save As window that appears, and then click **Save** to save the trace log information to the file.

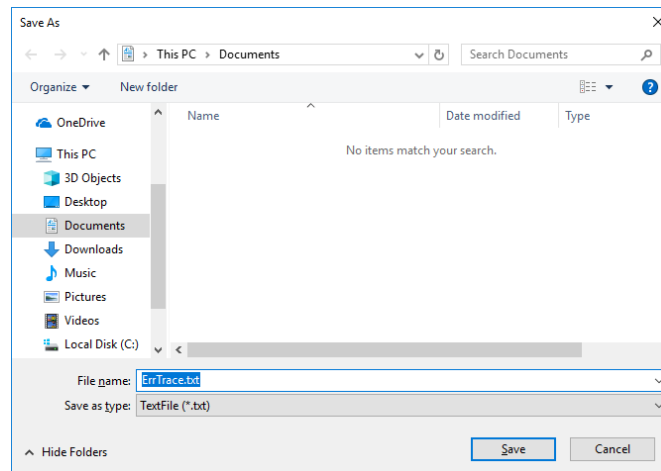

Figure 8-104 Save As window

- (6) Click **Close** to close the Display Ethernet Communication of Trace Log window.

8.4.6.9 RAS menu: DHP Information

Use this menu item to display a window in which you can set the DHP logging mode and view DHP trace information.

- (1) From the main menu, select **RAS** and then **DHP Information**.

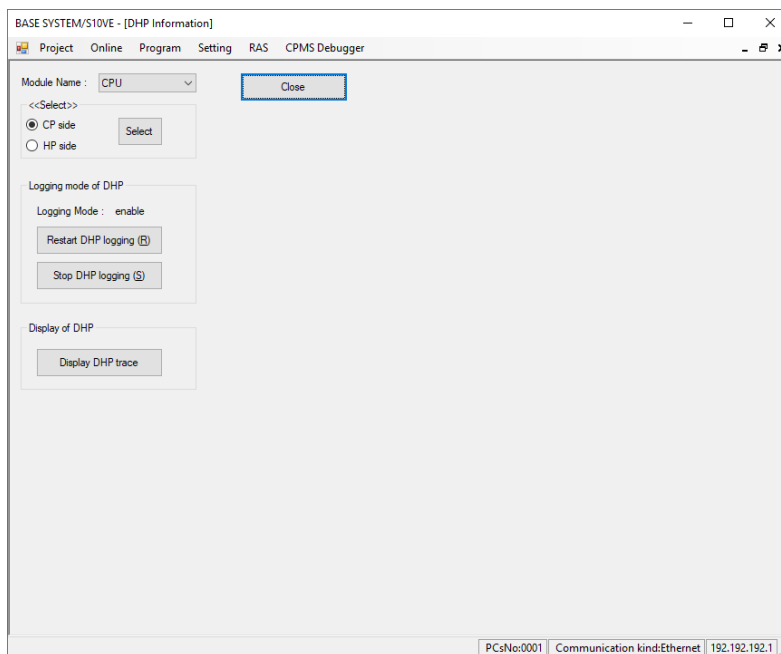

Figure 8-105 DHP Information window

- (2) The **Module Name** drop-down list shows the name of the CPU module, ET.NET main module, and ET.NET sub-module installed in the PCs. Select the module whose DHP information you want to display or set.
- (3) To display DHP information for the CP side, select the **CP side** radio button and then click **Select**. To display DHP information for the HP side, select the **HP side** radio button and then click **Select**. The **CPU side** and **HP side** radio buttons will be unavailable if you selected **ET.NET(MAIN)** or **ET.NET(SUB)** from the **Module Name** list.
- (4) The value shown for **Logging Mode** is the current logging mode of DHP information. To change the logging mode to enable, click **Restart DHP logging**. To change the mode to disable, click **Stop DHP logging**.
- (5) To display the DHP trace information, click **Display DHP trace**.

8. Tools

(6) The Display DHP trace window appears.

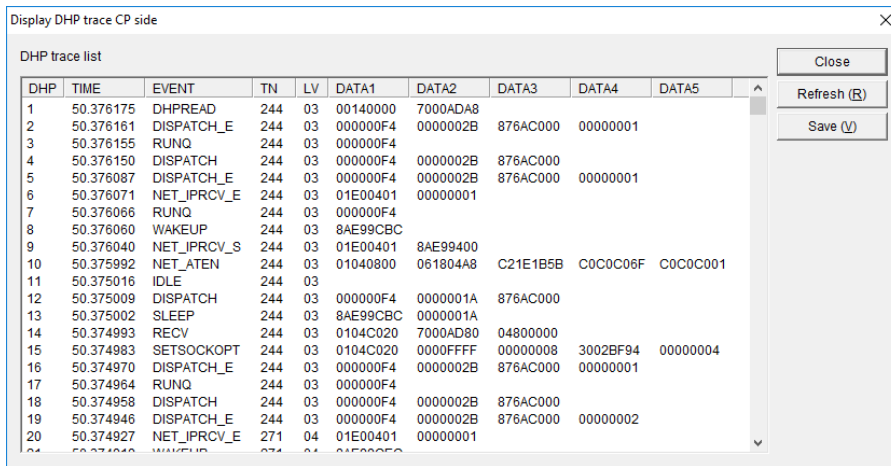

Figure 8-106 Display DHP trace CP side window

When displaying DHP trace information for the HP side, the window title is Display DHP trace HP side. When displaying DHP trace information for the ET.NET module (main or sub), the window title is Display DHP trace ET.NET(Main/Sub).

The following table lists the DHP trace information displayed in this window.

Item	Displayed information
DHP	The DHP trace display number.
TIME	The time at which the trace was recorded. tt.tttttt Second Time output to one microsecond
EVENT	The trace point type.
TN	The task number.
LV	The priority level.
DATA1 to DATA5	The trace data (in hexadecimal format).

- (5) To display the latest DHP trace information, click **Refresh**.
- (6) To save the displayed DHP trace information to a text file, click **Save**.
- (7) Click **Close** to close the Display DHP trace window (Figure 8-106).
- (8) Click **Close** to close the DHP Information window (Figure 8-105).

8.4.6.10 RAS menu: AutoSave

Use this menu item to create an autosave file and a fault analysis information file.

Confirm the following before using the AutoSave function:

- [1] The PADT is not connected to an ET.NET module.
- [2] The CPMS has been downloaded.
- [3] The CPU module is in STOP mode.

- (1) From the main menu, select **RAS** and then **AutoSave**.
- (2) The AutoSave window appears.

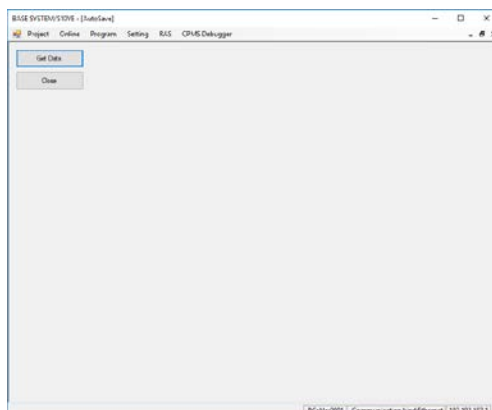

Figure 8-107 AutoSave window

- (3) To create an autosave file and a fault analysis information file, click **Get Data**.
 - You will be unable to use this feature if the communication type is ET.NET. In this case, an error message appears (Figure 8-50).
 - You will be unable to use this feature if the CPU is in RUN mode. In this case, the following error message appears:

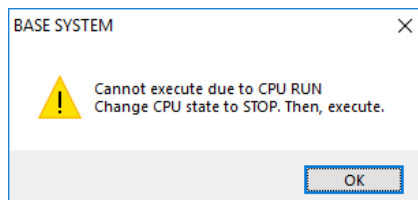

Figure 8-108 Error message when CPU is in RUN mode

- If communication fails with the CPU module in STOP mode, the system displays a message reporting a line error and another reporting an error with the `atdmpbs` command (Figure 8-109).

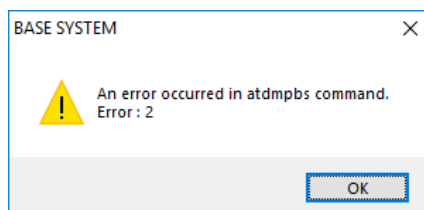

Figure 8-109 atdmpbs command error message

8. Tools

- To save an autosave file, perform the following procedure:
 - [1] In the file save window, specify a name for the autosave file (*XXXX.atdmp*).
 - [2] Click **Save**. The file save window closes and the Executing window appears (Figure 8-110).
 - [3] To close the file save window, click **Cancel**.

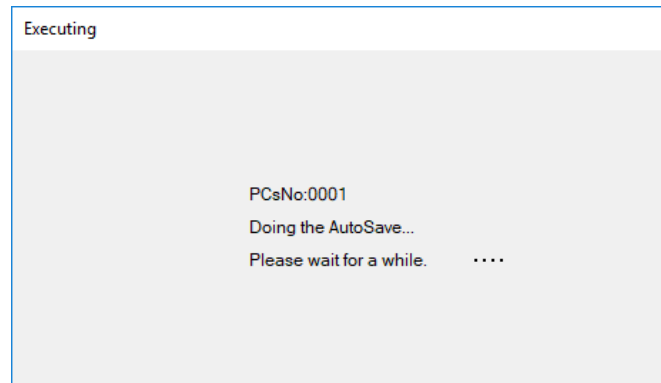

Figure 8-110 Executing window

- PCs No
The system displays the PCs number assigned to the PCs for which the AutoSave file is being saved.
- If the system successfully creates the autosave file and fault analysis information file, it displays a message indicating that processing has completed (Figure 8-111).

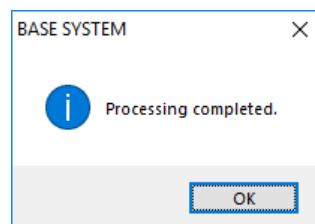

Figure 8-111 Processing completed message

The autosave file and fault analysis information file are given the following names:

Autosave file: *XXXX.atdmp*

Fault analysis information file (CP side): *XXXX_cp.txt*

Fault analysis information file (HP side): *XXXX_hp.txt*

XXXX is the file name you specify in the file save window.

- (5) Click **Close** to close the AutoSave window.

Structure of autosave file

Figure 8-112 shows the information output to the autosave file. An autosave file has the extension .atdmp, and is in binary format.

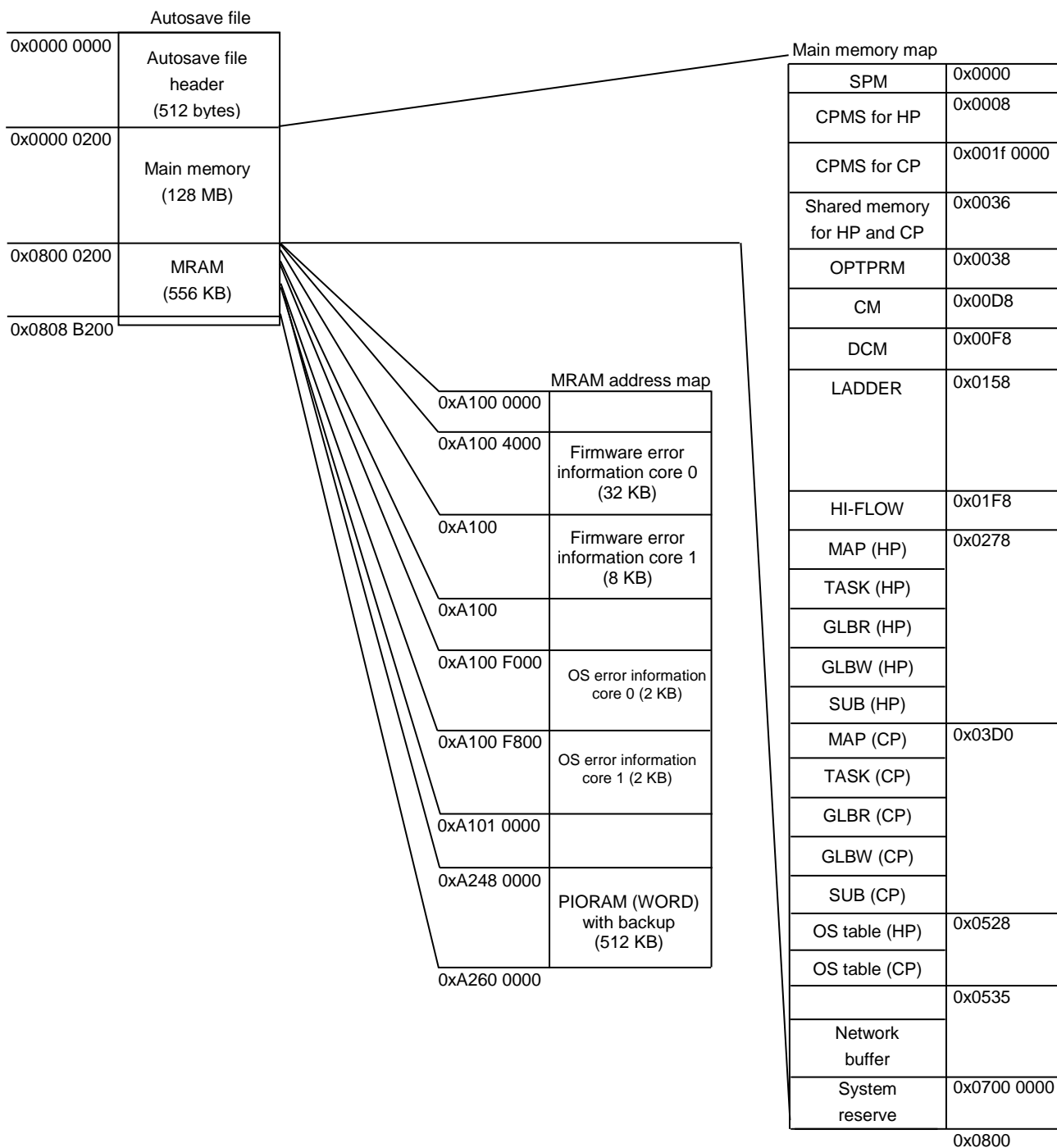

Figure 8-112 Structure of autosave file

8. Tools

Structure of fault analysis information file

Figure 8-113 shows the information output to the fault analysis information file. A fault analysis information file has the extension `.txt`, and is in text format.

No.	Description
1	Title 1
2	FATAL error log information
3	OSCB information
4	SYSCB information
5	HAICB information
6	Memory patrol information
7	Title 2
8	DHP information
9	Title 3
10	NONFATAL error log information
11	Title 4
12	TCB information
13	Title 5
14	UCB information
15	Title 6
16	TMCB information
17	Title 7
18	RSCB and RSVB information
19	Title 8
20	\$VER information
21	Title 9
22	Bus error count information

Figure 8-113 Format of fault analysis information file

Details of fault analysis information file

The following shows, in detail, the information output to the fault analysis information file. The numbers in parentheses correspond to the numbers in the No. column in Figure 8-113.

(1) Title 1

System trouble information	<i>AAA BBB CC DD:EE:FF</i>
<i>HHHH</i>	
SITE=XXXX	

(7) Title 2

Debugging helper trace list	<i>AAA BBB CC DD:EE:FF</i>
<i>HHHH</i>	
SITE=XXXX	

(9) Title 3

Non fatal error log. List	<i>AAA BBB CC DD:EE:FF</i>
<i>HHHH</i>	
SITE=XXXX	

(11) Title 4

Task Control Block list	<i>AAA BBB CC DD:EE:FF</i>
<i>HHHH</i>	
SITE=XXXX	

(13) Title 5

Unit Control Block list	<i>AAA BBB CC DD:EE:FF</i>
<i>HHHH</i>	
SITE=XXXX	

(15) Title 6

Timer Control Block list	<i>AAA BBB CC DD:EE:FF</i>
<i>HHHH</i>	
SITE=XXXX	

(17) Title 7

Reserve Control Block list	<i>AAA BBB CC DD:EE:FF</i>
<i>HHHH</i>	
SITE=XXXX	

(19) Title 8

Ver/Rev list	<i>AAA BBB CC DD:EE:FF</i>
<i>HHHH</i>	
SITE=XXXX	

(21) Title 9

BusError count list	<i>AAA BBB CC DD:EE:FF</i>
<i>HHHH</i>	
SITE=XXXX	

8. Tools

AAA: The day of the week on which the fault analysis information file was created.

BBB: The month in which the fault analysis information file was created.

CC: The day on which the fault analysis information file was created.

DD: The time (hour) when the fault analysis information file was created.

EE: The time (minute) when the fault analysis information file was created.

FF: The time (second) when the fault analysis information file was created.

HHHH: The year in which the fault analysis information file was created.

XXXX: The site name assigned to the PCs.

(2) FATAL error log information

FATAL error log information is output if it exists. A maximum of two items are output.

If there is no FATAL error log information, the message `No error log.` appears here.

(10) NONFATAL error log information

NONFATAL error log information is output if it exists. A maximum of 32 items are output.

If there is no NONFATAL error log information, the message `No error log.` appears here.

(3) OSCB information

```

<OSCB>
ctnr=xxxxxxx  tcnt=xxxxxxx  astcb=xxxxxxx  ascnt=xxxxxxx
boot time : xxx xxx xx xx:xx:xx xxx
idlesec =xxxxxxx  idlensec=xxxxxxx
ulsubctl=xxxxxxx  tcbba   =xxxxxxx  syscba =xxxxxxx  ucba    =xxxxxxx
trba     =xxxxxxx  rscba  =xxxxxxx  rsvba  =xxxxxxx  dhpa   =xxxxxxx
uslcbba =xxxxxxx  wdtdata=xxxxxxx  logtbl =xxxxxxx  tmcb   =xxxxxxx
schedtbla=xxxxxxx  ubcba  =xxxxxxx  adtba  =xxxxxxx  wiredlista=xxxxxxx
confunoa=xxxxxxx  rlinktop=xxxxxxx

```

ctnr: The task number of the task that is currently being executed.

tcnt: The number of registered tasks.

astcb: The task number of the task that issued the ASUSP.

ascnt: The number of times ASUSP was issued.

boot time: The CPMS startup time (as a number of seconds since 1970).

idlesec: The idle time since the CPMS started (in seconds).

idlensec: The idle time since the CPMS started (in nanoseconds).

ulsubctl: The address of the ulsubctl table.

tcbba: The address of the tcb table.

syscba: The address of the syscb table.

ucba: The address of the ucba table.

trba: The address of the trb table.

rscba: The address of the rscb table.

rsvba: The address of the rsvb table.

dhpa: The address of the trace_info table.

uslcbba: The address of the uslcb table.

wdtdata: The watchdog timer setting (in milliseconds).

logtbl: The address of the logtbl table.

tmcb: The address of the tmcb table.

schedtbla: The address of the sched_tbl table.

ubcba: The address of the ubcb table.

adtba: The address of the adtb table.

wiredlista: The address of the DMA transfer area management table.

confunoa: The address of the CONF_UNO table.

rlinktop: The physical address of the R.link space (P1 space).

(4) SYSCB information

```

<SYSCB>
cpu=x  cpmsver=xxxx  procno=x  pptype=xxxxxxx  realmem=xxxxxxx
site : xxx
tod=x  syntim=xxxxxxx  maxtn=xxx  maxun=xx  maxtm=xxx  maxrsv=xx
log_buf_top=xxxxxxx  log_buf_size=xxxxxxx
dhp_buf_top=xxxxxxx  dhp_buf_size=xxxxxxx
mbuf      =xxxxxxx  portflg      =xxxxxxx
multi_sys=X  sysno=x  maxpu=X  stopall=xx
cyclctl=xxxxxxx  netconf  =xxxxxxx  backup_top=xxxxxxx  pte=xxxxxxx
oswork =xxxxxxx  network  =xxxxxxx  iproute  =xxxxxxx  trb=xxxxxxxxx
ptmt    =xxxxxxx  srbcnt   =xx  mbufcnt   =xxx
s10area_top=xxxxxxx  s10area_size=xxxxxxx  logical_putype=x
osmode  =xxxxxxx  loopnmi  =xxxxxxx  netlsum   =xxxxxxx
cyce_top  =xxxxxxx  ncpe_cnt  =x      log_hold=xxxxxxx

```

cpu: The CPU type.

cpmsver: The CPMS version (issue number).

procno: The processor number.

pptype: The name of the installed tool.

realmem: The main memory size (in bytes).

site: The site name.

tod: The TOD synchronization flag.

syntim: The TOD synchronization time.

maxtn: The maximum number of registered tasks.

maxun: The maximum number of unit numbers.

maxtm: The maximum number of timers that can be registered at any one time.

maxrsv: The maximum number of shared resources that can be exclusively used at any one time.

log_buf_top: The address of the log area.

log_buf_size: The size of the log area.

dhp_buf_top: The address of the trace area.

dhp_buf_size: The size of the trace area.

mbuf: The mbuf address.

portflg: LANCE and serial port control.

multi_sys: Information about the CPU configuration.

sysno: The CPU type.

maxpu: The number of processors.

stopall: CPU stop request.

cyclctl: The address of the NCP control information.

netconf: The address of the RCTLNET configuration table.

backup_top: The address of the backup file.

pte: The address of the page table.

oswork: The address of the kernel work area.

network: The address of the RCTLNET table.

iproute: The address of the IP routing table.

trb: The address of the trb table.

ptmt: The address of the ptmt table.

srbcnt: The RCTLNET srb count.

mbufcnt: The mbuf count.

s10area_top: The physical address where the S10 space starts in physical memory.

s10area_size: The size of the S10 space in physical memory (in bytes).

logical_putype: The logical processor unit type.

osmode: The CPMS application type.

loopnmi: Whether an OS in-loop check is required.

netlsum: The address of the LANCE configuration information.

cyce_top: The address of the CM for RCTLNET.

ncpe_cnt: The number of RCTLNET definitions.

cyce_log_hold: The log deletion setting for when the CPU starts after a reset.

(5) HAICB information

```
<HAICB>
puvars =xxxxxxx machine=xxxxxxx
```

puvars: The address of the puvar table.

machine: The address of the machine table.

(6) Memory patrol information

```
<MEMPATTL>
mempat_addr=xxxxxxx mempat_cnt =xxxxxxx
mempat_log =xxxxxxx mempat_idx =xxxxxxx
mempat_err =xxxxxxx mempat_total=xxxxxxx
tv_sec[0]=xxxx
ecc3status = xxxxxx ecc3coradr = xxxxxx ecc3cordat = xxxxxx
ecc3cordat_ul = xxxxxx ecc3corsum = xxxxxx
tv_sec[1]=xxxx
ecc3status = xxxxxx ecc3coradr = xxxxxx ecc3cordat = xxxxxx
ecc3cordat_ul = xxxxxx ecc3corsum = xxxxxx
tv_sec[2]=xxxx
ecc3status = xxxxxx ecc3coradr = xxxxxx ecc3cordat = xxxxxx
ecc3cordat_ul = xxxxxx ecc3corsum = xxxxxx
tv_sec[3]=xxxx
ecc3status = xxxxxx ecc3coradr = xxxxxx ecc3cordat = xxxxxx
ecc3cordat_ul = xxxxxx ecc3corsum = xxxxxx
tv_sec[4]=xxxx
ecc3status = xxxxxx ecc3coradr = xxxxxx ecc3cordat = xxxxxx
ecc3cordat_ul = xxxxxx ecc3corsum = xxxxxx
```

mempat_addr: The refresh start address.

mempat_cnt: Error counter.

mempat_log: Warning output flag.

mempat_idx: The pointer to the saved timestamps (first entry).

mempat_err: Single bit error flag.

mempat_total: Total number of errors that have occurred.

tv_sec[1 to 4]: The error time 1 (in seconds) Note: If no error has occurred, ----- is displayed.

ecc3status: The access source block.

ecc3coradr: The address to be corrected.

ecc3cordat: Coding data after correction.

ecc3cordat_ul: Coding data before correction.

ecc3corsum: The number of ECC3 corrections.

(14) UCB information

```

*** UCB = xxxx ***
dev =xxxxxxx dva  =xxxxxxx
conf=xxxxxxx tout =xxxxxxx status=xxxx flags=xxxx
ext =xxxxxxx ioerba=xxxxxxx
                                ...
                                ...
                                ...
                                (24 sets of information)

```

UCB = xxxx: The USB number.

dev: The device number.

dva: The device address (unused).

conf: Configuration data.

tout: The timeout time (to the 10 millisecond level).

status: The device status.

flags: Processing flags.

ext: The address of the device extension table.

ioerba: The address of the IOERB table.

(16)!TMCB information

```

*** TMCB ***
uatrp=xxxxxxx urtrp=xxxxxxx ftrp=xxxxxxx
*** uatrp ***
FP          INTM          CYTM          TN  FACT ID
xxxxxxx xxxxxxx xxxxxxx xxxxxxx xxxxxxx xxx xxx x
                                ...
                                ...
                                ...
*** urtrp ***
FP          INTM          CYTM          TN  FACT ID
xxxxxxx xxxxxxx xxxxxxx xxxxxxx xxxxxxx xxx xxx x
                                ...
                                ...
                                ...
                                (Maximum of 512 sets of information)

```

uatrp: The start TRB address of the absolute time TRB queue.

urtrp: The start TRB address of the relative time TRB queue.

ftrp: The start TRB address of the unused TRB queue.

FP: The pointer to the next TRB.

INTM: The startup time (displayed to the nanosecond).

CYTM: The cycle time (displayed to the nanosecond).

TN: The start task number.

FACT: The start factor.

ID: The timer type.

8. Tools

(18) RSCB and RSVB information

```

*** RSCB ***
max=xxxxxxx emp=xxxxxxx lockf=xxxxxxx
*** RSVB ***
No  COUNT  PRF    TN    TOP      LAST
  x  xxxx   xxx   xxx  xxxxxxx  xxxxxxx
                                     ...
                                     ...
                                     ...
                                     (32 sets of information)

```

max: The total number of sets of RSVB information.

emp: The number of unused sets of RSVB information.

lockf: The table lock flag.

No: The number of RSVB tables.

COUNT: (Not used)

PRF: The privileged reservation issuance flag (0: rserv, 1: prsv).

TN: The task number of the task that has exclusive use of the shared resource.

TOP: The start address of the shared resource (GLB).

LAST: The end address of the shared resource (GLB).

(20) \$VER information

No	PPName	PPversion	SInumber	loadpkg
1	CPMS/S10VE	XX-XX	XX	XX/XX/XX
XX:XX:XX				
2	RCTLNET/S10VE	XX-XX	XX	XX/XX/XX
XX:XX:XX				
3	RPDP/S10VE	XX-XX	XX	XX/XX/XX
XX:XX:XX				
		...		
		...		
		...		
(Maximum of 64 sets of information)				

No: The number of registered pieces of tool information.

PPName: The name of the tool.

PPversion: The version and revision numbers of the tool.

SInumber: The SI number of the tool.

loadpkg Time: When the tool information was registered.

(22) Bus error count information

```

S10VE (MP)
mwdpe =xxxxxxx rta  =xxxxxxx trnsto=xxxxxxx mape=xxxxxxx
mrdpe =xxxxxxx ma   =xxxxxxx brqto =xxxxxxx
rtryov=xxxxxxx mserr=xxxxxxx nruto =xxxxxxx
S10VE (SPU)
mwdpe =xxxxxxx rta  =xxxxxxx trnsto=xxxxxxx mape=xxxxxxx
mrdpe =xxxxxxx ma   =xxxxxxx brqto =xxxxxxx
rtryov=xxxxxxx mserr=xxxxxxx nruto =xxxxxxx

```

mwdpe: The number of times WDPE reception was detected while operating as a bus master.

rta: The number of times an error transaction was detected.

trnsto: The number of times a transaction timeout was detected.

mape: The number of times APE reception was detected while operating as a bus master.

Mrdpe: The number of times RDPE reception was detected while operating as a bus master.

ma: The number of times an address cycle timeout was detected.

brqto: The number of times a bus request timeout was detected.

Rtryov: The number of times the retry count limit was reached.

mserr: The number of times SERROR reception was detected while operating as a bus master.

Nruto: The number of times an internal timeout error was detected.

- The fault analysis file on the CP side also contains bus error count information for slots 0 to 7.

The output format is as follows:

```

SLOTX
maae =xxxxxxx piome =xxxxxxx ackbusyto=xxxxxxx rserr =xxxxxxx
invcmd=xxxxxxx sta   =xxxxxxx tape    =xxxxxxx tdpe  =xxxxxxx
me   =xxxxxxx noddack(S10 BUS)           =xxxxxxx noddack=xxxxxxx
tserr =xxxxxxx

```

...

(Seven sets of information)

SLOT: The master slot number.

maae: The number of invalid byte enables detected while operating as a target.

piome: The number of times a no BGACK output timeout was detected.

ackbusyto: The number of times a BGACK busy timeout was detected.

rserr: The number of times SERROR reception was detected.

invcmd: The number of invalid commands detected.

sta: The number of times transmission of an error transaction was detected.

tape: The number of times an APE was detected while operating as a target.

tdpe: The number of times a WPDE was detected while operating as a target.

me: The number of times a 2-bit ECC error was detected during read operations.

noddack(S10 BUS): The number of times a no DTACK output timeout was detected.

noddack: The number of times a no DTACK output timeout (minor fault) was detected.

tserr: The number of times SERROR reception was detected while operating as a target.

8. Tools

8.4.7 CPMS debugger functions

CPMS debugger functions are available from the **CPMS Debugger** menu.

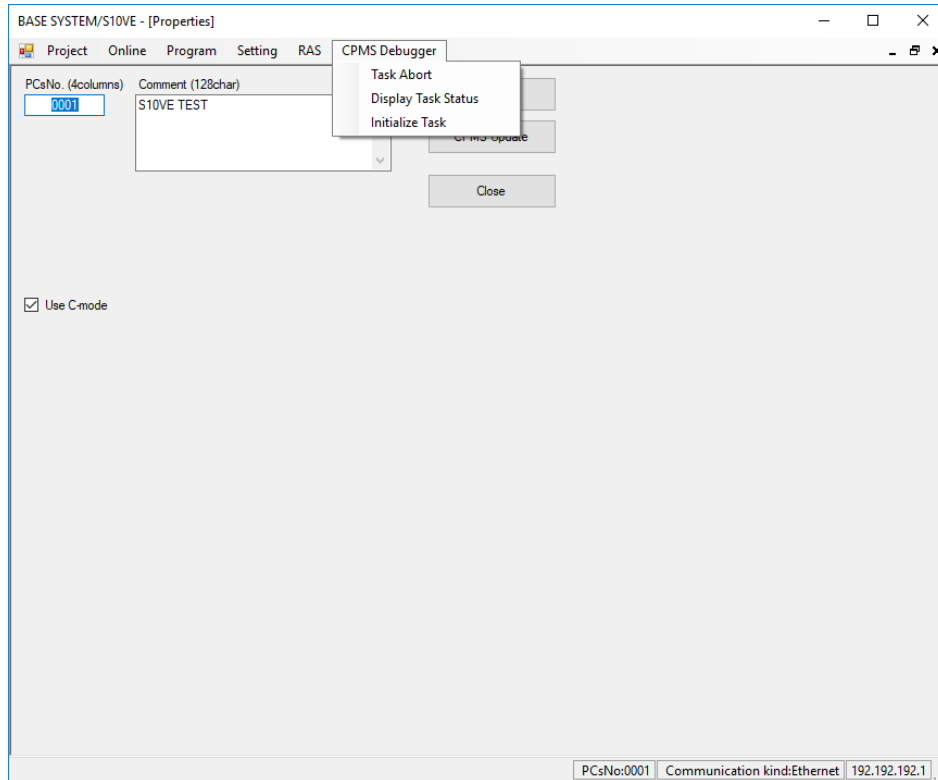

Figure 8-114 Window after clicking the CPMS Debugger menu

The following table lists and describes the CPMS debugger functions:

Table 8-16 List of CPMS Debugger menu items

No.	Category			Description
	Level 1	Level 2	Level 3	
1	CPMS Debugger	Task Abort	--	Places a task in a condition that not allow its execution.
2		Display Task Status	--	Displays the status of registered tasks in a list.
3		Initialize Task	--	Initializes the task environment.

8.4.7.1 CPMS Debugger menu: Task Abort

Use this menu item to inhibit a task from starting.

- (1) From the main menu, select **CPMS Debugger**, and then **Task Abort**.
- (2) The Task Abort window appears.

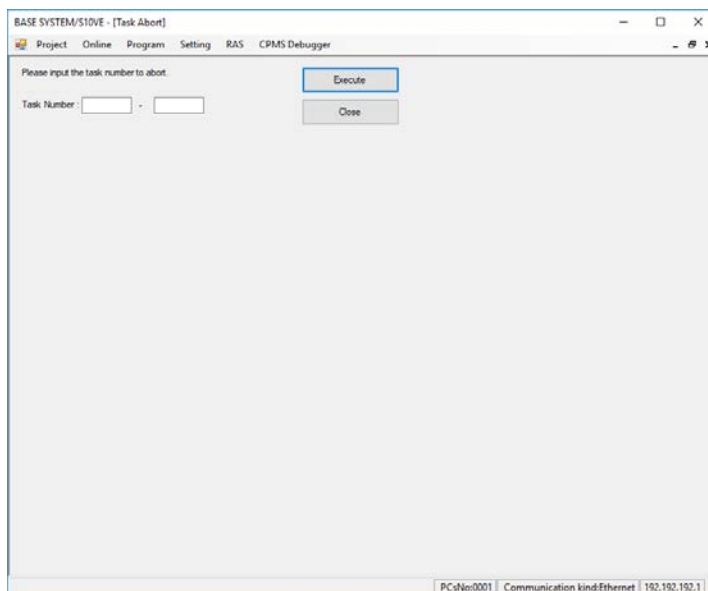

Figure 8-115 Task Abort window

Task Number

Specify the task number of the task whose start you want to suppress, as a number from 1 to 229.

- (3) Click **Execute** to suppress start of the task with the specified task number.
- (4) A confirmation window appears asking you to confirm that you want to abort the task.

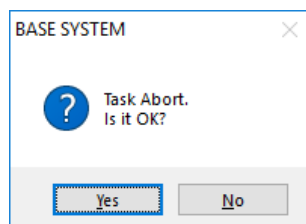

Figure 8-116 Task abort confirmation message

Click **Yes** to suppress startup of the specified task.

If the system successfully suppresses startup of the task, it displays a message indicating that the process is complete.

If suppression fails, the system displays an error message. For details on the error messages displayed in this scenario, see No. 19 and No. 20 in *Table 8-52 RPC error messages*.

If you click **No**, you are returned to the Task Abort window without startup of the specified task being suppressed.

- (5) Click **Close** to close the Task Abort window.

8.4.7.2 CPMS Debugger menu: Display Task Status

Use this menu item to display the status of registered tasks.

- (1) From the main menu, select **CPMS Debugger** and then **Display Task Status**.
- (2) The Task Status window appears.

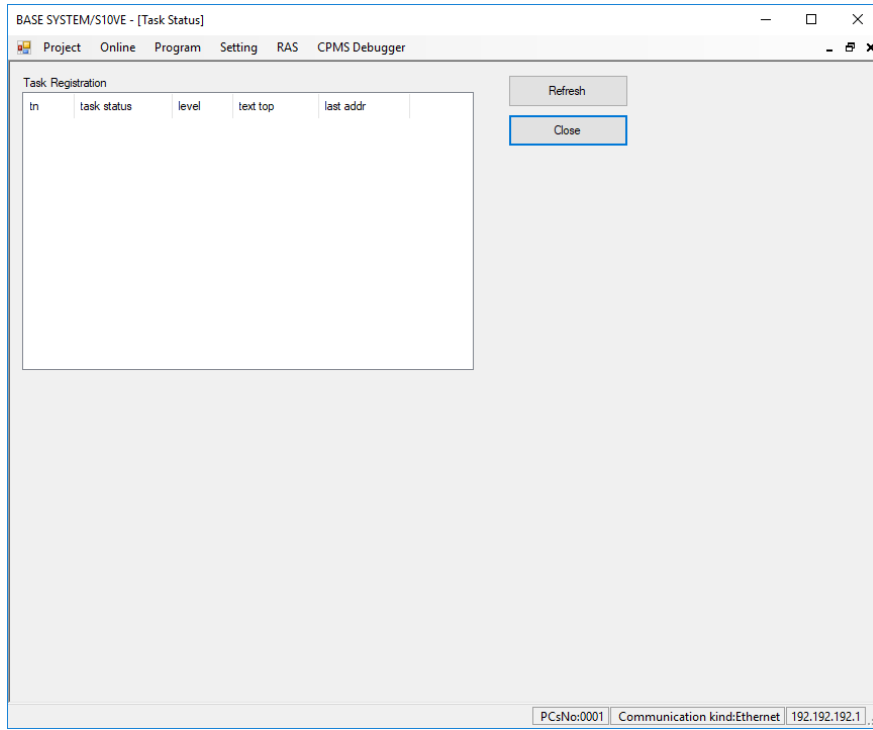

Figure 8-117 Task Status window

- (3) Click **Refresh** to display a list of registered tasks and their status in the **Task Registration** area. The following table describes the information displayed in the **Task Registration** area of the Task Status window.

Table 8-17 Information in Task Registration area

No.	Heading	Description	Remarks
1	tn	Task number	--
2	task status	Task status	See Table 8-18
3	level	Execution level (Initial execution level)	--
4	text top	Task start address	--
5	last addr	Task end address	--

Table 8-18 Task statuses

No.	Shown as	Description
1	DORMANT	Start is suppressed
2	IDLE	Waiting to start
3	READY	Running or waiting to execute
4	WAIT	Waiting for an event
5	SUSPENDED	Execution is suppressed

- (4) Click **Close** to close the Task Status window.

8.4.7.3 CPMS Debugger menu: Initialize Task

Use this menu item to initialize the task environment.

Confirm the following before initializing the task environment:

- [1] The PADT is not connected to an ET.NET module.
- [2] CPMS has been downloaded.
- [3] The hardware CPU RUN/STOP switch is set to RUN.

- (1) From the main menu, select **CPMS Debugger** and then **Initialize Task**.
If the communication type is ET.NET, an error message indicating that the function cannot be used with ET.NET is displayed (Figure 8-50) when you click **Execute**.
- (2) The Initialize Task window appears.

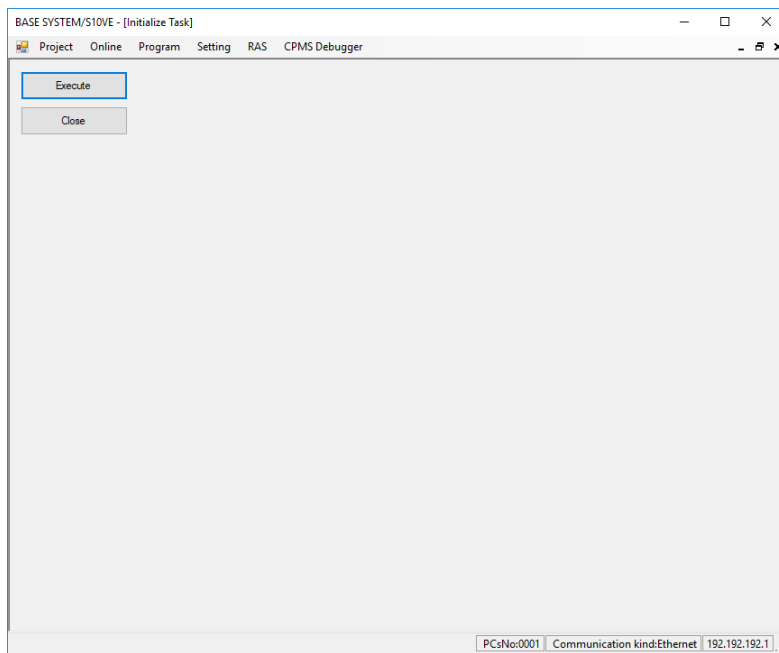

Figure 8-118 Initialize Task window

- (3) To initialize the task environment, click **Execute**.
- If CPMS has not been downloaded, the system displays an error message to that effect (Figure 8-119).

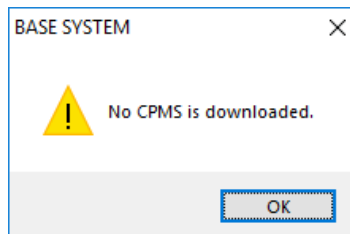

Figure 8-119 Error message when CPMS is not downloaded

- If the hardware CPU RUN/STOP switch is set to STOP, the system displays an error message indicating that execution is impossible for that reason (Figure 8-52).

- (4) If the environment can be initialized, the system displays a message asking you to confirm that you want to reset it (Figure 8-32).
To begin initializing the task environment, click **OK**.
If you click **Cancel**, initialization of the task environment is canceled.
If initialization of the task environment fails to start, an error message appears indicating that the data could not be read. (Figure 8-120).

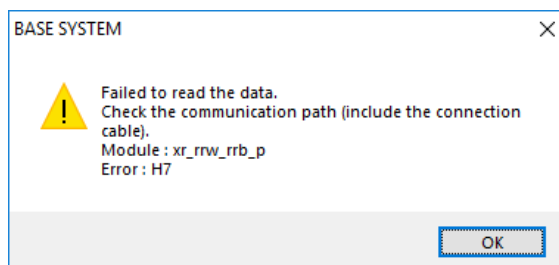

Figure 8-120 Error message displayed when data cannot be read

In this case, check the communication path and review the ST numbers in the Change PCs window. Then, try initializing the task environment again using revised ST numbers.

- (5) The following window appears displaying the progress of task environment initialization:

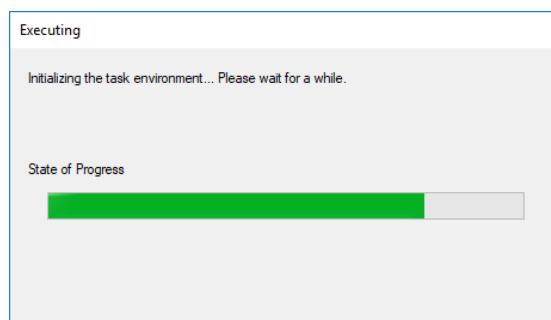

Figure 8-121 Progress window (initializing task environment)

- If the ROM load operation fails during task environment initialization, the system displays a message asking you to confirm re-execution of the ROM load operation (Figure 8-54). If this message appears, turn the PCs off and on again, and then click **OK**.
If you click **Cancel**, the system displays an error message indicating that the ROM load operation has failed (Figure 8-55).
If the message asking for confirmation of ROM load re-execution appears again when you click **OK**, click **Cancel** and use the information provided by the CPU indicators to identify and resolve the fault. For details on how to perform fault analysis, see *Chapter 13. Troubleshooting*.

8. Tools

For details about the ROM load operation, see *SDRAM state during ROM load operation* in 8.5.5 *Scope of backup, restoration, and comparison*.

When initialization has completed, a **Close** button appears in the progress window. The CPU enters STOP mode while the task environment is being initialized. When initialization is complete, the CPU returns to RUN mode.

- (7) Click **Close** to close the Initialize Task window.

8.5 BACKUP RESTORE SYSTEM

8.5.1 Backup

You can use BACKUP RESTORE SYSTEM to back up the data on the CPU module.

Confirm the following before backing up the CPU data:

- [1] The PADT is not connected to an ET.NET module.
- [2] The hardware CPU RUN/STOP switch is set to RUN.

- (1) From the BASE SYSTEM main menu, select **Online** and then **Backup**. If the communication type is ET.NET, an error message indicating that the function cannot be used with ET.NET is displayed (Figure 8-50).

If the CPU mode of the PCs is RUN, a message appears asking you to confirm that the CPU mode can be changed to STOP.

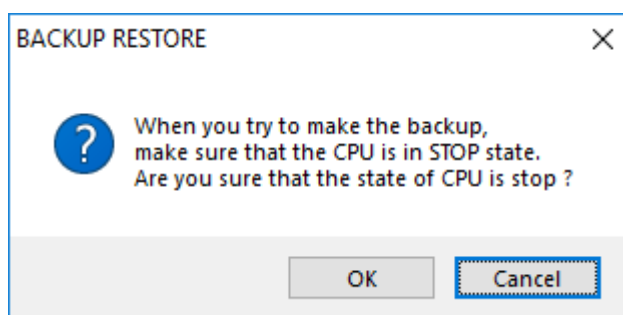

Figure 8-122 CPU stop confirmation message for backup function

Click **OK** to place the CPU in STOP mode.

If you click **Cancel**, a message appears indicating that the backup process will be canceled.

Click **OK**. You are returned to the BASE SYSTEM window.

As when replacing the CPU module, this message does not appear if the CPU module is already in STOP mode.

8. Tools

- (2) The Backup window appears.

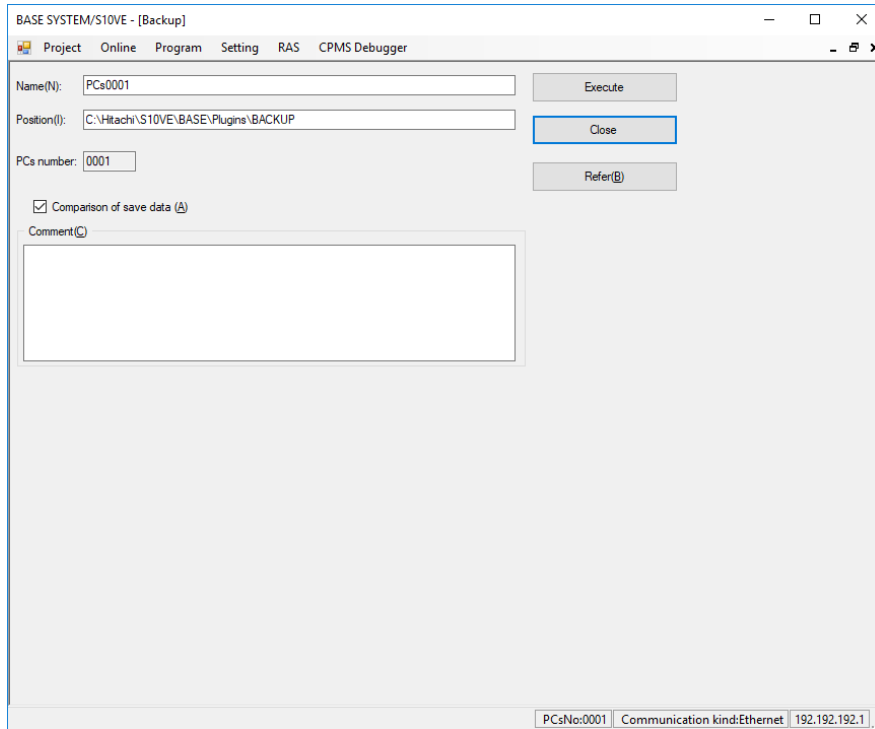

Figure 8-123 Backup window

- (3) The **Name** field displays the default name of the backup folder.

Specify the name of the folder in which you want to save the backup data (the *backup folder*). You can enter a maximum of 200 characters.

The default is PCsNNNN, where NNNN is a four-digit PCs number.

- (4) In the **Position** field, specify the location at which to create the backup folder. You can enter a maximum of 200 characters. You can select a path by clicking the **Refer** button. When you click **Refer**, a Browse For Folder dialog box appears in which you can select a folder. The total number of characters including the folder name and path cannot exceed 200 characters.

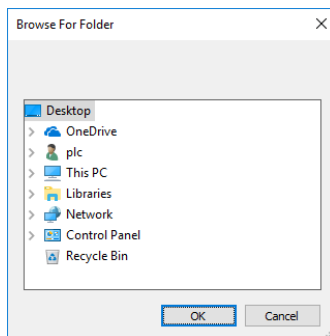

Figure 8-124 Browse For Folder dialog box

- (5) Enter a comment in the **Comment** field, if needed.
- (6) If you want the system to verify the received backup data to confirm that it has been saved correctly, select the **Comparison of save data** check box.
- (7) Click **Execute** to begin the backup process.
If the backup folder you specify already exists, a message appears asking you to confirm that you want to overwrite the existing data. Click **OK** to overwrite the existing data with the received backup data. If you click **Cancel**, you are returned to the Backup window.

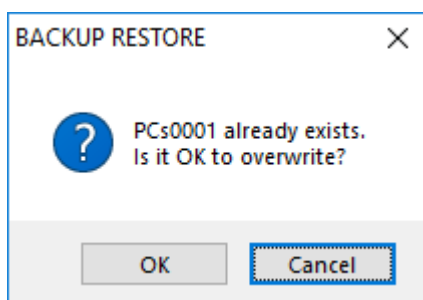

Figure 8-125 Overwrite confirmation message

- (8) After approximately 30 seconds, reception of the backup data begins, and the State of backup window appears as follows:

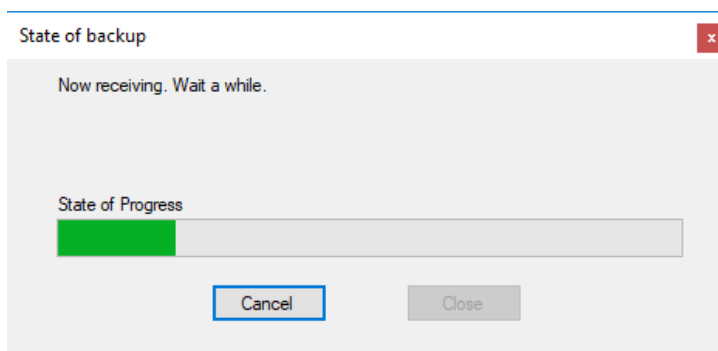

Figure 8-126 State of backup window (when receiving data)

If you click **Cancel**, a message appears asking you to confirm that you want to cancel the backup operation.

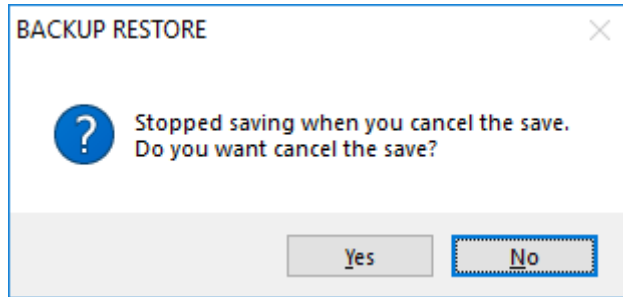

Figure 8-127 Backup cancelation confirmation message

If you click **Yes** in this dialog box, a message appears asking you to confirm that you want to change the CPU mode to RUN (Figure 8-128).

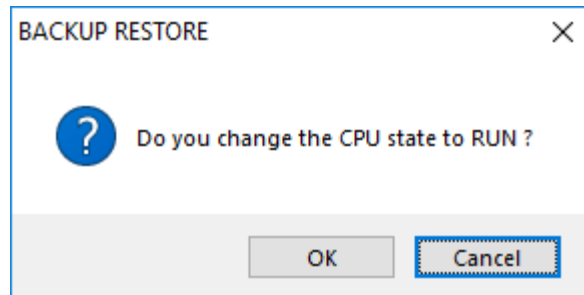

Figure 8-128 CPU RUN confirmation message

When you click **OK** in this message, the State of backup window appears as follows:

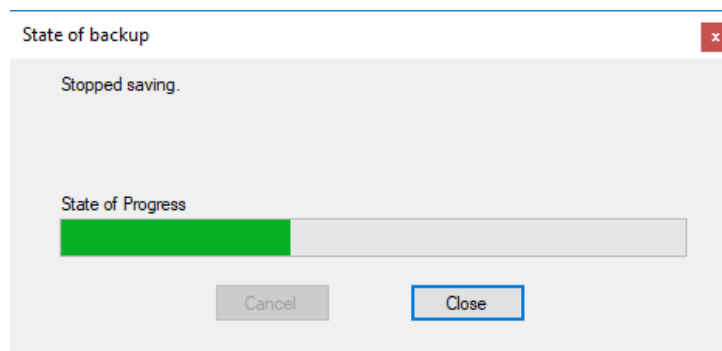

Figure 8-129 State of backup window (when backup is canceled)

If you respond **Cancel** to the CPU RUN confirmation message, a message appears letting you know how to recover from STOP mode (Figure 8-130).

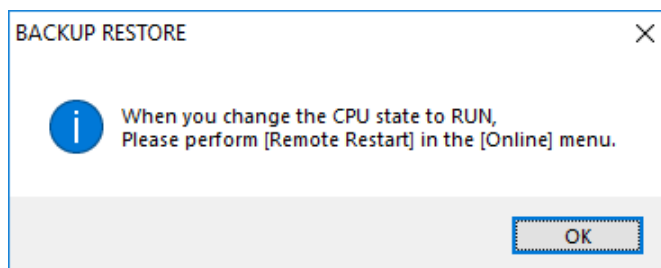

Figure 8-130 STOP recovery guidance message

Click **OK** to dismiss the message. The State of backup window appears indicating that backup was canceled.

Click **Close** in this State of backup window to return to the Backup window (Figure 8-123).

- (9) If you selected the **Comparison of save data** check box, the system compares the backup data it receives with the data on the PCs. During this comparison, the State of backup window appears as follows:

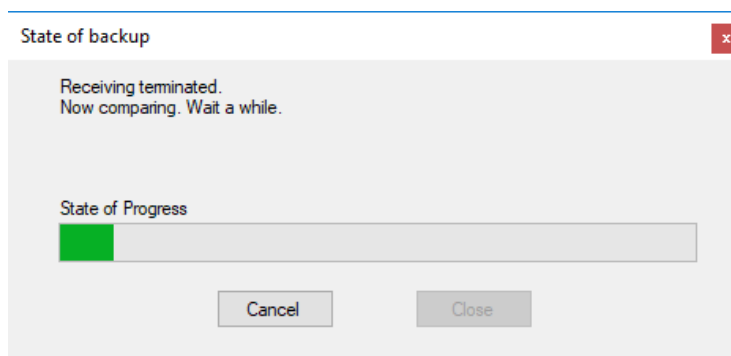

Figure 8-131 State of backup window (when comparing data)

If you click **Cancel**, a message appears asking you to confirm that you want to cancel data comparison (Figure 8-132).

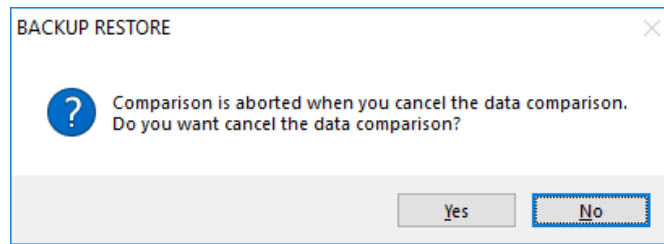

Figure 8-132 Data comparison cancelation confirmation message

If you respond **Yes** to this message, a CPU RUN confirmation message (Figure 8-128) appears. When you click **OK** in the CPU RUN confirmation message, the State of backup window (Figure 8-133) appears.

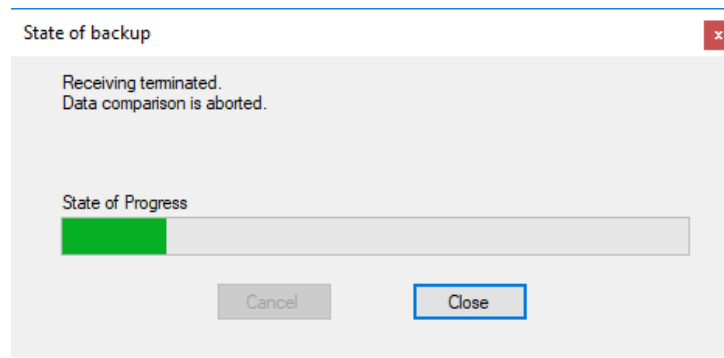

Figure 8-133 State of backup window (when data comparison is canceled)

If you respond **Cancel** to the CPU RUN confirmation message, a message appears letting you know how to recover from STOP mode (Figure 8-130). Click **OK** to dismiss the message. The State of backup window appears.

Click **Close** in this State of backup window to return to the Backup window.

- If the State of backup window does not appear during the backup process, it might be hidden behind the active window. To check whether this is the case, align your mouse pointer with the BASE SYSTEM icon on the Windows taskbar.
- When you create a backup for a CPU module in which an FL.NET module (LQE702-E) is installed, the ERR LED on the FL.NET module will start to blink. This is normal.

- (10) The behavior after the system has received the backup data and compared it with the data on the PCs (if the comparison option is enabled) depends on the state the CPU module is in when the backup process starts.

If the CPU is in RUN mode when the backup process starts, go to a).

As with CPU module replacement, if the CPU is in STOP mode when the backup starts, go to b).

- (a) When the backup process finishes, a message appears asking you to confirm that you want to place the CPU module in RUN mode.

In this case, check the State of backup window behind the active window.

If the message indicates that there are no inconsistencies in the backup data, return to the CPU RUN confirmation message and click **OK**. The CPU module is placed in RUN mode. If you click **Cancel**, the CPU module remains in STOP mode and the system displays a message letting you know how to recover from STOP mode. Click **OK** to dismiss the message.

Click **Close** in the State of backup window (Figure 8-134).

You are returned to the Backup window. Go to step (11).

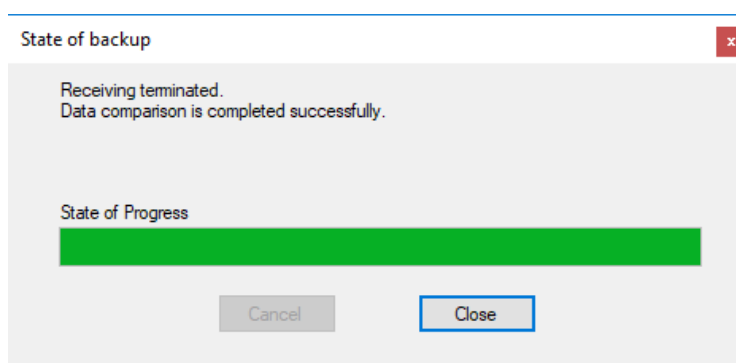

Figure 8-134 State of backup window (when no inconsistencies are found)

If the message indicates that inconsistencies were found in the backup data (Figure 8-135), you will need to perform the backup process again. Return to the CPU RUN confirmation message and click **Cancel** to leave the CPU module in STOP mode. The message letting you know how to recover from STOP mode (Figure 8-130) appears. Click **OK** to dismiss the message. The version of the State of backup window that indicates there are inconsistencies in the backup data appears. Click **Close**. You are returned to the Backup window. Go to step (11).

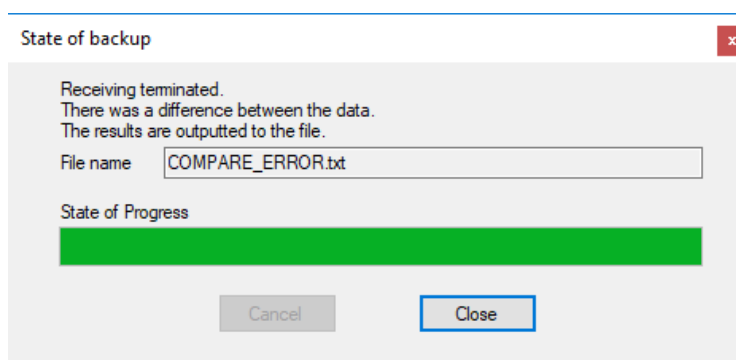

Figure 8-135 State of backup window (when inconsistencies are found)

- (11) Click **Close** in the Backup window (Figure 8-123) to complete the backup process and return to BASE SYSTEM. If the data comparison found inconsistencies in the backup data, you will need to perform the backup process again.

Notice

- Do not restore backup data that the data comparison found to be inconsistent. Doing so can cause the system to malfunction.

LED states during backup

Backup state	LED state (CPU module)		Description
	RUN	STBY	
CPU STOP instruction issued	OFF	ON	The user has clicked OK in the CPU STOP confirmation message.
Immediately after execution	OFF	BLINK	The user has just clicked the Execute button (The contents of the NAND flash memory are being copied to main memory).
Data reception has started	OFF	ON	Data is being received from the PCs.
Data reception has finished	OFF	ON	Data has been received from the PCs.
Data comparison has started	OFF	ON	The received data is being compared with the data on the PCs.
Data comparison has finished	OFF	ON	The received data has been compared with the data on the PCs.

ON: The LED is lit. BLINK: The LED is blinking. OFF: The LED is off.

8.5.2 Restore

You can use **BACKUP RESTORE SYSTEM** to restore backup data to the CPU module.

CPMS might not be installed on the CPU module to which you want to restore the backup data, such as when the CPU module is new. In this case, from the **BASE SYSTEM** main menu, select **Online** and then **Change PCs**. In the Change PCs window that appears, set FF as the ET# and 192.192.192.1 as the IP address by following the procedure in *8.4.3.1 Online menu: Change PCs*.

Confirm the following before restoring backup data to the CPU module:

- [1] The PADT is not connected to an ET.NET module.
 - [2] The hardware CPU RUN/STOP switch is set to RUN.
- (1) From the **BASE SYSTEM** main menu, select **Online** and then **Restore**. You will be unable to use this feature if the communication type is ET.NET. In this case, an error message appears (Figure 8-50). If the CPU module of the PCs is in RUN mode, a message appears asking you to confirm that you want to place the CPU in STOP mode (Figure 8-137). If the CPU module of the PCs is in STOP mode, an error message appears indicating that the function cannot be used for this reason (Figure 8-52). In this case, you will be unable to restore the backup data.

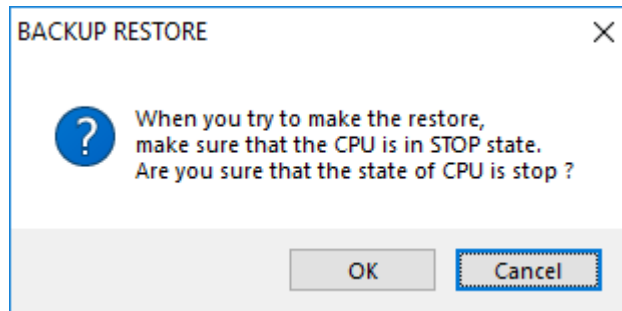

Figure 8-137 CPU stop confirmation message for data restoration

Click **OK** to place the CPU module in STOP mode.

If you click **Cancel**, a message appears indicating that data restoration was canceled. Click **OK** to dismiss the message. You are returned to the **BASE SYSTEM** window.

As when replacing the CPU module, this message does not appear if the CPU module is already in STOP mode.

- (2) The Restore window appears.

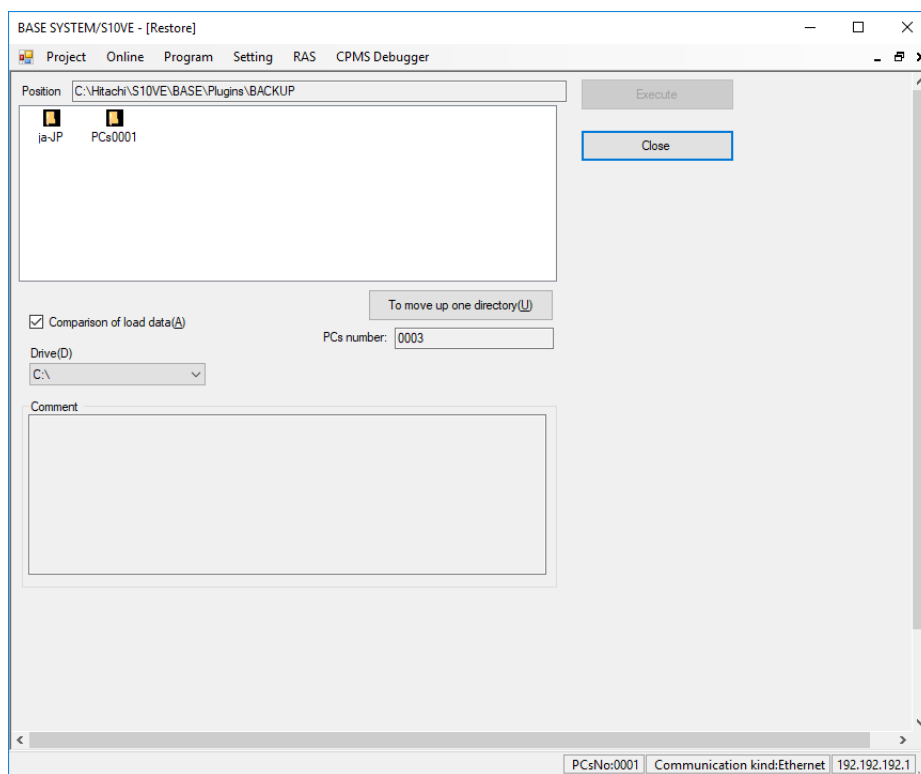

Figure 8-138 Restore window

- (3) The **Position** field displays the path of the backup folders.
From the list of folders, select the backup folder whose backup data you want to restore.
The **Execute** button becomes available when you select a folder from which backup data can be restored.
- (4) The **PCs number** field shows the PCs number of the PCs to which BASE SYSTEM is connected.
If the CPU module is new, 0000 is displayed as the PCs number.
- (5) If you want the system to compare the local data with the data on the PCs to confirm that it was sent correctly, select the **Comparison of load data** check box.
- (6) Click the **Execute** button to start data restoration.

8. Tools

- (7) If the PCs to which you are restoring the data has a different PCs number from the PCs where the backup was taken, the system displays a message asking you to confirm that you want to continue. If you click **OK**, the system proceeds with the restoration process. If you click **Cancel**, you are returned to the Restore window.

This message does not appear if you are restoring a backup to a new CPU module.

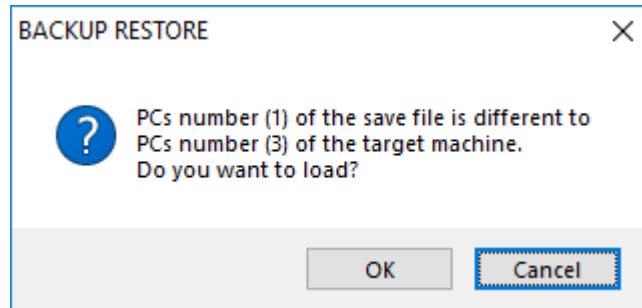

Figure 8-139 Message asking whether to continue restoration

- (8) The system displays the following State of Restore window while the data to be restored is being transferred:

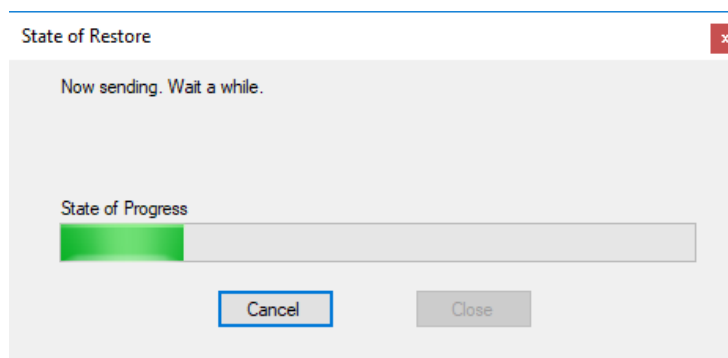

Figure 8-140 State of Restore window (when sending data)

- (9) If you selected the **Comparison of load data** check box, when the system has sent the data to be restored, it starts to compare the sent data with its locally stored counterpart. During this comparison process, the State of Restore window appears as follows:

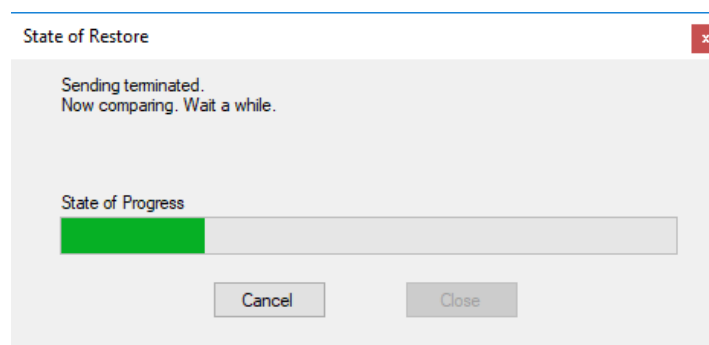

Figure 8-141 State of Restore window (when comparing data)

- If the State of Restore window does not appear during the restoration process, it might be hidden behind the active window. To check whether this is the case, align your mouse pointer with the BASE SYSTEM icon on the Windows taskbar.
- When you restore data to a CPU module in which an FL.NET module (LQE702-E) is installed, the ERR LED on the FL.NET module will start to blink. This is normal.

(10) When the restoration process has finished, the system displays a message asking you to confirm that you want to change the PCs number of the PCs to which the data was restored.

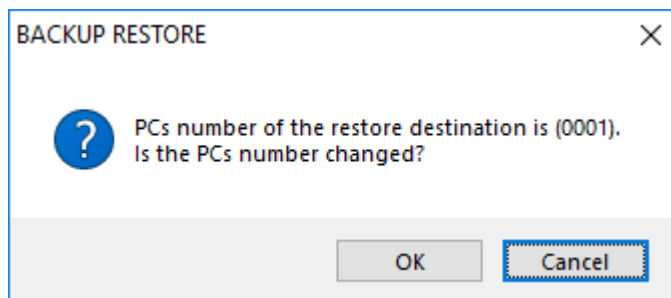

Figure 8-142 Confirmation message for PCs number change

As when replacing the CPU module, if you want to perform a standard restoration in which the PCs number remains unchanged, click **Cancel**. You are returned to the State of Restore window. Go to step (12).

If you want to change the PCs number, click **OK**. A window appears in which you can change the PCs number setting of the backup data.

(11) In the following window, you can change the PCs number of the backup data you have restored.

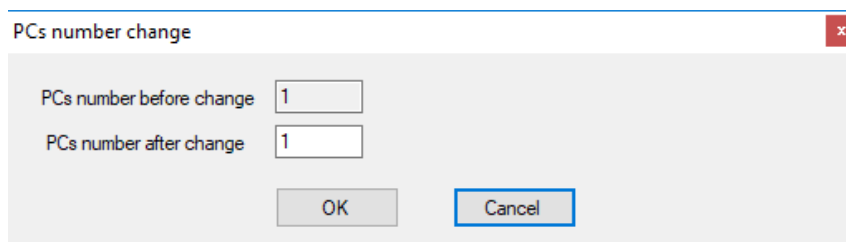

Figure 8-143 Window for changing PCs number of restored PCs

By changing the PCs number and then clicking **OK**, you can change the PCs number of the restored PCs from the PCs number saved in the backup data. If you click **Cancel**, the PCs number in the backup data is assigned to the PCs to which the data was sent, and the restoration process continues.

8. Tools

- (12) The behavior after the system has sent the data and compared it with the local data (if the comparison option is enabled) depends on the state of the CPU module when the restoration process was started. If the CPU was in RUN mode when the restoration process started, go to (a). As with CPU module replacement, if the CPU was in STOP mode when the restoration process started, go to (b).

- (a) When the restoration process finishes, a message appears asking you to confirm that you want to place the CPU module in RUN mode (Figure 8-144). Click **OK** to place the CPU module in RUN mode. If you click **Cancel**, the CPU module remains in STOP mode and the system displays a message letting you know how to recover from STOP mode (Figure 8-145). Click **OK** to dismiss the message.

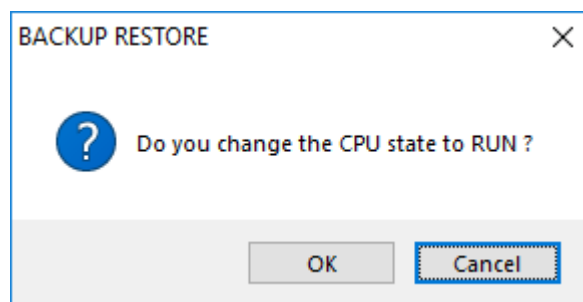

Figure 8-144 CPU RUN confirmation message

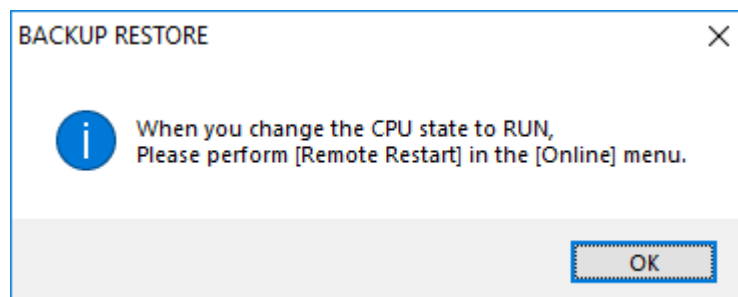

Figure 8-145 STOP recovery guidance message

If the comparison finds inconsistencies in the data, the CPU module enters STOP mode and the system displays the message letting you know how to recover from STOP mode. Click **OK** to dismiss the message.

- (b) If the CPU module is in STOP mode when you start the restoration process, it remains in STOP mode when the restoration process finishes. The system will then display the message letting you know how to recover from STOP mode. Click **OK** to dismiss the message.

- (13) If the comparison does not find any inconsistencies, the system displays a window indicating that data comparison completed successfully. Click **Close**. You are returned to the Restore window.

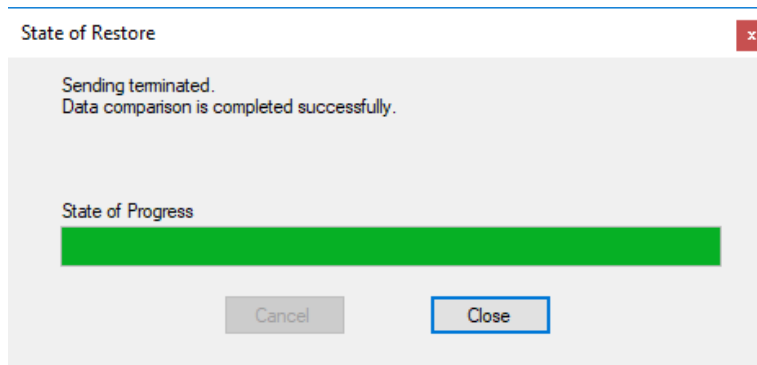

Figure 8-146 State of Restore window (when no inconsistencies are found)

If the comparison finds inconsistencies in the data, the system displays a window indicating that inconsistent data was found and creates the comparison error data file `COMPARE_ERROR.txt` (Figure 8-136) in the specified folder.

Click **Close**. You are returned to the Restore window. Go to step (2) and perform the restoration process again.

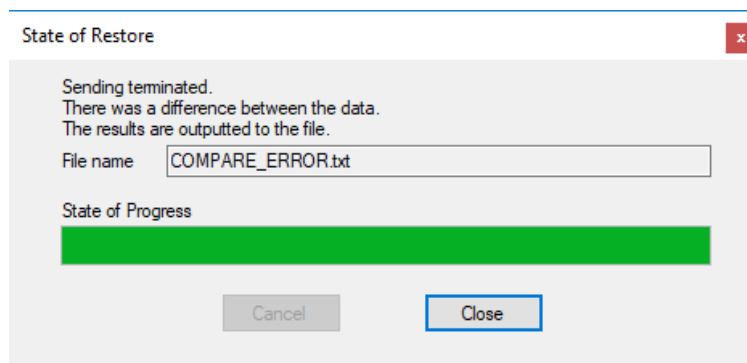

Figure 8-147 State of Restore window (when inconsistencies are found)

- (14) Click **Close** in the Restore window. The restoration process finishes and you are returned to the BASE SYSTEM window.
- (15) If the comparison finds inconsistencies in the data and there is already a `COMPARE_ERROR.txt` file in the specified folder, the system displays a message asking you to confirm that you want to overwrite the existing file. Click **Yes** to overwrite the file with the results of the latest comparison.

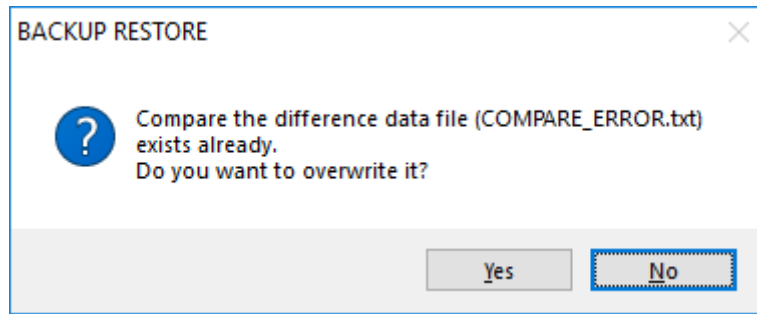

Figure 8-148 Confirmation message for overwriting comparison error data file

Notice	
<ul style="list-style-type: none"> To avoid malfunction, do not place the CPU module in RUN mode if the data comparison has found the data to be inconsistent. In this case, perform the restoration process again, and do not turn the system on and off again until the issue is resolved. 	

LED states during restoration

Restoration state	LED state (CPU module)		Description
	RUN	STBY	
CPU STOP instruction issued	OFF	ON	The user has clicked OK in the CPU STOP confirmation message.
Immediately after execution	OFF	BLINK	The user has just clicked the Execute button (The contents of the NAND flash memory are being copied to main memory).
Data transmission has started	OFF	ON	Data is being transmitted to the PCs. The system has displayed the State of Restore window.
Data transmission has finished (1)	OFF	BLINK	Data has been transmitted to the PCs (the contents of the main memory are being copied to NAND flash memory).
Data transmission has finished (2)	OFF	ON	Data transmission to the PCs has completed.
Data transmission has finished (3)	OFF	BLINK	The system is preparing to compare the data (the contents of NAND flash memory are being copied to main memory).
Data comparison has started	OFF	ON	The data on the PCs is being compared with the data on the PADT.
Data comparison has finished	OFF	ON	The data on the PCs has been compared with the data on the PADT.
Transmission of user area data has started	ON	OFF	User area data is being sent to the PCs.
Transmission of user area data has finished	ON	OFF	User area data has been sent to the PCs.
User area comparison has started	ON	OFF	The user area data stored on the PCs is being compared with the data on the PADT.
User area comparison has finished	ON	OFF	The user area data stored on the PCs has been compared with the data on the PADT.

ON: The LED is lit. BLINK: The LED is blinking. OFF: The LED is off.

8.5.3 Backup save data comparison

You can use BACKUP RESTORE SYSTEM to compare the data in a backup file with the data on the CPU module.

Confirm the following before comparing the backup file with the data on the CPU module:

- [1] The PADT is not connected to an ET.NET module.
- [2] The hardware CPU RUN/STOP switch is set to RUN.

(1) From the BASE SYSTEM main menu, select **Online** and then **Backup save data comparison**. You will be unable to use this feature if the communication type is ET.NET. In this case, an error message appears (Figure 8-50).

If the CPU module of the PCs is in RUN mode, a message appears asking you to confirm that you want to place the CPU in STOP mode (Figure 8-149).

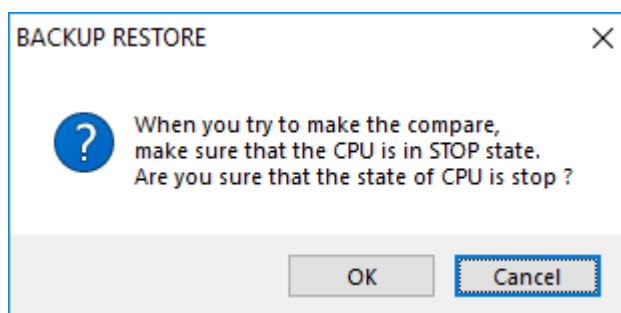

Figure 8-149 CPU stop confirmation message for backup data comparison

Click **OK** to place the CPU module in STOP mode.

If you click **Cancel**, a message appears indicating that backup data comparison was canceled.

This message does not appear if the CPU module is already in STOP mode.

8. Tools

- (2) The Backup save data comparison window appears.

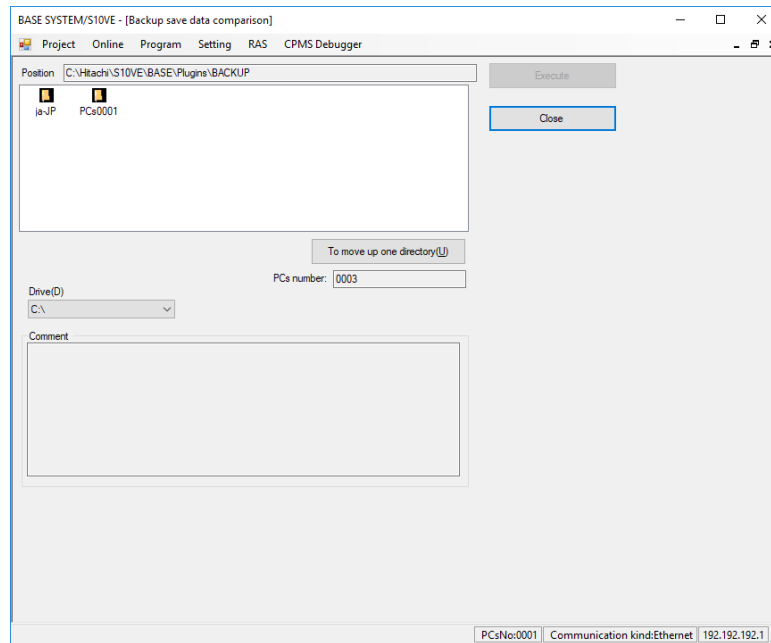

Figure 8-150 Backup save data comparison window

- (3) The **Position** field displays the path of the backup folders. Select the backup folder whose backup data you want to compare. The **Execute** button becomes available when you select a folder whose backup data can be compared.
- (4) The **PCs number** field shows the PCs number of the PCs to which BASE SYSTEM is connected.
- (5) Select the backup data in the folder list, and then click **Execute** to start comparing the backup data.
- (6) If the specified backup file has a different PCs number from the PCs whose data you are comparing it with, the system displays a message asking you to confirm that you want to continue with the comparison (Figure 8-151).
If you click **OK**, the system proceeds with the comparison. If you click **Cancel**, data comparison is canceled and you are returned to the Backup save data comparison window (Figure 8-150).

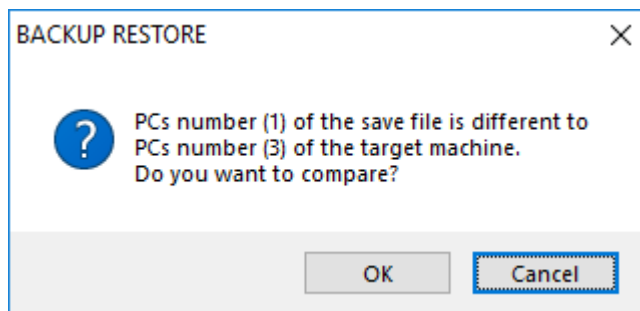

Figure 8-151 Message asking whether to continue backup data comparison

- (7) After approximately 30 seconds, comparison of the backup data begins, and the State of Backup save data comparison window appears (Figure 8-152). The **Close** button is unavailable until data comparison has completed.

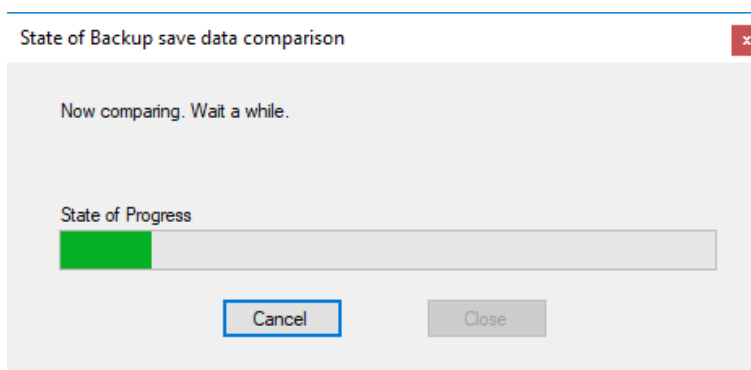

Figure 8-152 State of Backup save data comparison window (during data comparison)

- (8) If you click **Cancel** in the State of Backup save data comparison window, a message appears asking you to confirm that you want to cancel backup data comparison (Figure 8-153).

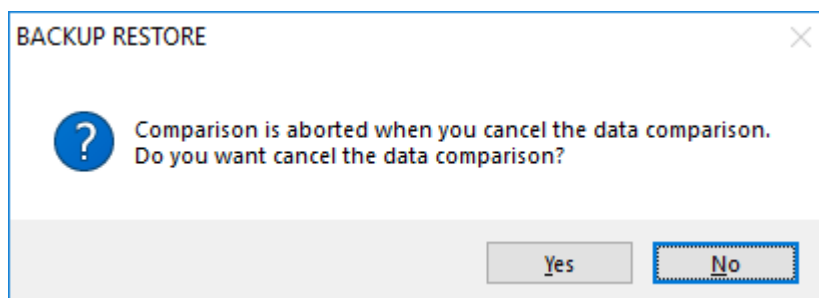

Figure 8-153 Confirmation message when canceling backup data comparison

If you click **No**, comparison of the backup data resumes. If you click **Yes**, data comparison is aborted and the contents of the State of Backup save data comparison window changes accordingly (Figure 8-154).

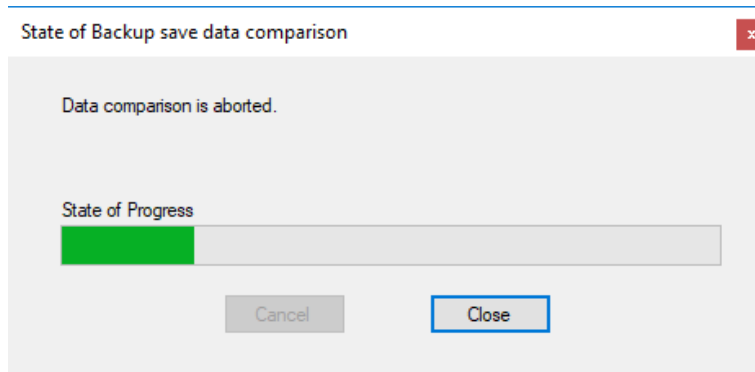

Figure 8-154 State of Backup save data comparison window (when data comparison is canceled)

- (9) If comparison of the backup data has completed and no inconsistencies were found, the State of Backup save data comparison window appears as follows (Figure 8-155).

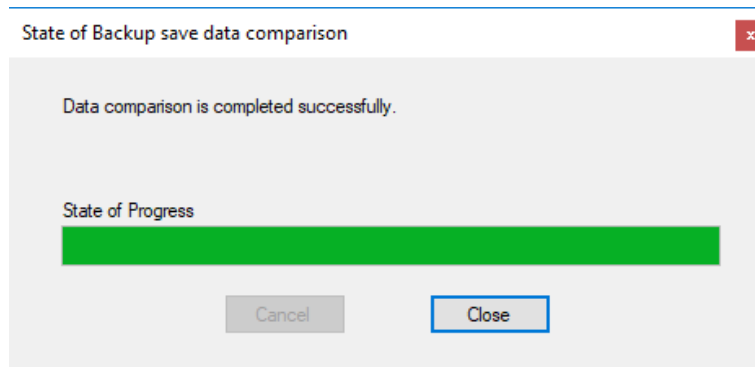

Figure 8-155 State of Backup save data comparison window (when no inconsistencies are found)

- (10) If comparison of the backup data reveals inconsistencies with the data on the PCs, the State of Backup save data comparison window appears as follows (Figure 8-156).

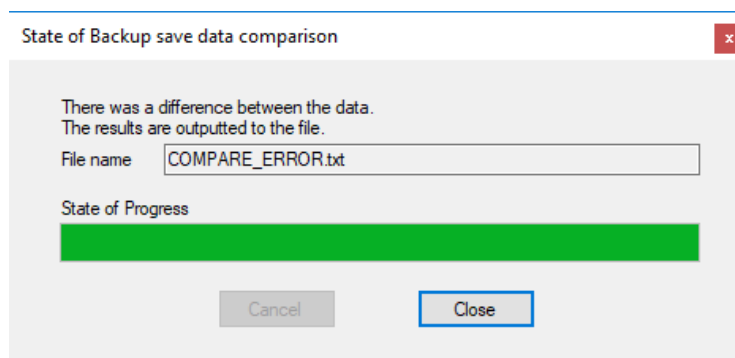

Figure 8-156 State of Backup save data comparison window (when outputting comparison error data file)

If the comparison finds inconsistencies in the data, the system creates a comparison error data file (COMPARE_ERROR.txt) in the specified backup folder (Figure 8-136). If there is already a COMPARE_ERROR.txt file in the specified folder, the system displays a message asking you to confirm that you want to overwrite the existing file (Figure 8-157).

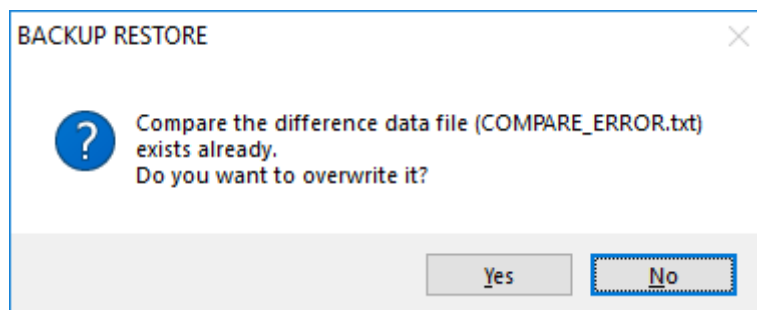

Figure 8-157 Confirmation message for overwriting comparison error data file

Click **Yes** to overwrite the existing COMPARE_ERROR.txt file in the specified backup folder. If you click **No**, the existing file is not overwritten.

- (11) If the CPU mode of the CPU module was changed to STOP at the beginning of this procedure, a CPU RUN confirmation message appears when the backup data comparison is finished or canceled (Figure 8-144).
- (12) If you respond **OK** to the CPU RUN confirmation message, the system changes the CPU mode to RUN. If you respond **Cancel**, the CPU remains in STOP mode and a message appears letting you know how to recover from STOP mode (Figure 8-145).

8. Tools

LED states during backup data comparison

State of backup data comparison	LED state (CPU module)		Description
	RUN	STBY	
CPU STOP instruction issued	OFF	ON	The user has clicked OK in the CPU STOP confirmation message.
Immediately after execution	OFF	BLINK	The user has just clicked the Execute button (ROM load operation is taking place).
Data reception has started	OFF	ON	Data is being received from the PCs.
Data reception has finished	OFF	ON	Data has been received from the PCs.
Data comparison has started	OFF	ON	The data on the PADT is being compared against the received data.
Data comparison has finished	OFF	ON	The data on the PADT has been compared against the received data.

- If the State of Backup save data comparison window does not appear during the backup data comparison process, it might be hidden behind the active window. To check whether this is the case, align your mouse pointer with the BASE SYSTEM icon on the Windows taskbar.
- When you compare backup data with the data on a CPU module in which an FL.NET module (LQE702-E) is installed, the ERR LED on the FL.NET module will start to blink. This is normal.

8.5.4 Duration of backup/restoration processes

The following table shows how long the system takes to perform backup, restoration, and backup data comparison. Use this as a general guide for real-world use.

Each process can take more or less time depending on the performance of the PADT.

The times in the table were measured on a PADT with the following specifications:

Installed memory: 2 GB

CPU: Core™ i5 @ 2.53GHz

OS: Microsoft® Windows® 10 Professional

Table 8-19 Measured backup/restoration times

Command		Time taken
Backup	Without comparison	5 minutes 00 seconds
	With comparison	5 minutes 45 seconds
Restoration	Without comparison	9 minutes 10 seconds
	With comparison	9 minutes 55 seconds
Backup data comparison		5 minutes 00 seconds

8. Tools

8.5.5 Scope of backup, restoration, and comparison

This section explains the scope of backup, restoration, and backup data comparison in BASE SYSTEM/S10VE.

(1) Scope of backup

Table 8-20 Scope of backup

Scope			Backup file name	Remarks
Memory type	Addresses	Size		
MRAM	HA108 0000 to HA11F FFFF	1.5 MB (1,572,864 bytes)	backup3 .bur	#1
SDRAM	HA400 4000 to HA400 407F (H0000 0020 to H0000 0020) #2	0.125 KB (128 bytes)	backup1 .bur	OS firmware I/F (only HA400 4000, HA400 400A4, and HA400 4070 have the same values as the NAND flash memory)
	HA400 C100 to HA400 DFFF (H0000 0060 to H0000 006F) #2	7.75 KB (7,936 bytes)		RPDP usage area (same values as NAND flash memory)
	HA408 0000 to HAAFB FFFF (H0000 0400 to H0003 7DFF) #2	111.25 MB (116,654,080 bytes)		OS management area (HA408 0000 to HA93D 9FFF have the same values as NAND flash memory)

#1: PI/O RAM backup area (512 KB) and user area (1 MB)

#2: The first SDRAM address range is the physical address range in SDRAM. The address range in parentheses is the corresponding address range in NAND flash memory. The data copied from the NAND flash memory to SDRAM is stored in the file backup1 .bur, and the MRAM data is stored in the file backup3 .bur.

SDRAM state during ROM load operation

When creating or comparing backup data, downloading the CPMS, or initializing the task environment, the data in the areas of the NAND flash memory shown in Figure 8-158 is copied to SDRAM by performing a ROM load operation. The data is then read from the SDRAM in a cold-started state.

When a ROM load operation takes place, the entire main memory is initialized. If you are using the S10 bus memory space shown in 3.1 Logical space in the *S10VE Software Manual CPMS General Description and Macro Specifications* (manual number SEE-3-201) as the user area, you can use the data transmit/receive function of LADDER DIAGRAM SYSTEM/S10VE to back up and restore the user area as needed.

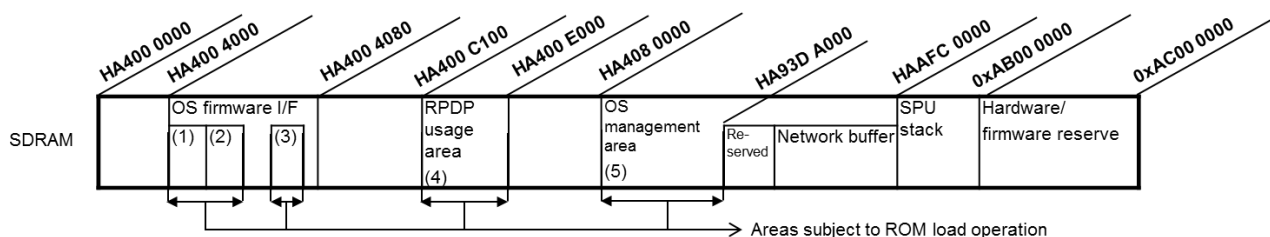

The part of the OS management area that is subject to the ROM load operation is determined based on the final address of the entire ROM image in the NAND flash memory. The final address of the ROM image in the NAND flash memory is set when BASE SYSTEM/S10VE executes the CPMS download function, and is always HA93 DA00.

- (1) Core 1 OS link address setting area (HA400 4000 to HA400 4003)
- (2) Core 0 OS link address setting area (HA400 4004 to HA400 4007)
- (3) Final addresses of ROM image (HA400 4070 to HA400 4073)
- (4) RPD P usage area (HA400 C100 to HA400 DFFF)
- (5) OS management area (HA408 0000 to HA93D 9FFF)

Figure 8-158 Areas subject to ROM load operation

About the NX user buffer area

The NX user buffer area (H0100 0000 to H01FF FFFF) was subject to backup operation in the S10V, but is not subject to backup operation in the S10VE. To back up or restore data in the NX user buffer area, use the data transmit/receive function of LADDER DIAGRAM SYSTEM/S10VE to select **Save new** (or **Save**) or **Send** in online mode. For details about how to use the data transmit/receive function, see 4.7.11 *Send/receive data in the S10VE Software Manual Operation Ladder Diagram System for Windows®* (manual number SEE-3-131).

8. Tools

(2) Scope of restoration

Table 8-21 Scope of restoration

Scope			Purpose	Remarks
Memory type	Addresses	Size		
SDRAM	HA400 4000 to HA400 407F	0.125 KB (128 bytes)	OS firmware I/F	
	HA400 C100 to HA400 DFFF	7.75 KB (7,936 bytes)	RPDP usage area	
	HA408 0000 to HAAFB FFFF	111.25 MB (116,654,080 bytes)	OS management area	
MRAM	HA108 0000 to HA11F FFFF	1.5 MB (1,572,864 bytes)	#2	
NAND flash memory	H0000 0020 to H0000 0020 ^{#1}	1 sector (512 bytes)	OS firmware I/F	
	H0000 0060 to H0000 006F ^{#1}	16 sectors (8,192 bytes)	RPDP usage area	Residual data is excluded
	H0000 0400 to H0002 9EDF ^{#1}	170,720 sectors (approx. 83 MB)	OS management area	ROM load operation extends to the final address of the ROM image

#1: Corresponding address in NAND flash memory

#2: PI/O RAM backup area (512 KB), user area (1 MB)

(3) Scope of comparison

The system compares the same range of data as that in (1) Scope of backup and (2) Scope of restoration.

However, the area in the following table is excluded from comparison because the results will show a discrepancy:

Table 8-22 Area excluded from backup data comparison

Area	Address
Option module error information table	0xA10D 0000 to 0xA10D 41FF

8.6 Other functions

8.6.1 Operation history recording function

The operation history recording function records the operation history of BASE SYSTEM.

This function can record a maximum of 1,024 operation history items. When this number is reached, the system deletes old entries as it adds new ones. Operation history is saved to a file when BASE SYSTEM is shut down.

Data is output in descending order of when it occurred. That is, the most recent information appears at the beginning of the file.

BASE SYSTEM saves operation history to a file named `S10VElog.txt`, which is stored in the same folder as the BASE SYSTEM executable files.

The format of the operation record file is as follows:

Date	Time	Operation details
2018/01/01	12:05:00	End
2018/01/01	12:04:00	Change PCs:Close
2018/01/01	12:03:30	Change PCs:Set (ST#=1, IP=192.168.1.10)
2018/01/01	12:03:10	Change PCs (ST#=255, IP=192.192.192.1)
2018/01/01	12:03:00	Open (PCsNO=0001)
	:	

Figure 8-159 Format of operation record file

8. Tools

■ List of operation history items

The following table lists the operations that are recorded in the operation record file:

Table 8-23 Items in operation record file (1/3)

No.	Menu item	Format
1	New	New (PCsNO=xxxx)
2	Open	Open (PCsNO=xxxx)
3	Close	Close (PCsNO=xxxx)
4	Delete	Delete (PCsNO=xxxx)
5	Set Network	Set Network
6	Download CPMS	Download CPMS
7	End	End
8	Change PCs	Change PCs (ST#=x, IP=xxx.xxx.xxx.xxx)
9	Display PCs STATUS and Change PCs STATUS	Display PCs STATUS and Change PCs STATUS
10	Data send/receive	Data send/receive
11	Remote Restart	Remote Restart
12	Remote Reset	Remote Reset
13	Data Clear	Data Clear
14	LADDER	LADDER execute
15	HI-FLOW	HI-FLOW execute
16	Setting Tool	Setting Tool
17	Set Time	Set Time
18	Module List	Module List
19	Error Log Display	Error Log Display
20	MCS	MCS
21	Display Performance	CPU Performance
22	Event Register	CPU Event Register
23	DHP Information	DHP information
24	AutoSave	AutoSave
25	Task Abort	TASK abort
26	Display Task Status	TASK STATUS
27	Initialize Task	TASK INIT

(Cont.)

Table 8-23 Items in operation record file (2/3)

No.	Menu item	Button	Format
28	Properties	Save	Property:Save
29		CPMS Update	Property:CPMS Updating
30		Close	Property:Close
31	Project List	Open	Projects:Open
32		Close	Projects:Close
33		Delete	Projects>Delete
34	Set Network	Set	Network:Set
35		Delete	Network: Delete
36		Write PCs	Network:Write PCs
37		Close	Network:Close
38	Download CPMS	Download	Download CPMS:Download
39		Close	Download CPMS:Close
40	Change PCs	Set	Change PCs:Set (ST#=x, IP=xxx.xxx.xxx.xxx)
41		Test	Change PCs:Test
42		Close	Change PCs:Close
43	PCs Status	Get Status	PCs Status:Get
44		Change Status	PCs Status:Change (Item=xxx, Status=xxxx -> xxx)
45		Close	PCs Status:Close
46	Data Send/Receive	Send	Data send/receive:Send(NO=xxxx, name=xxxx)
47		Receive	Data send/receive:Receive(NO=xxxx, name=xxxx)
48		Compare	Data send/receive:Compare
49		Delete	Data send/receive>Delete
50		Close	Data send/receive:Close
51	Set Time	Write PCs	Set Time:Write PCs
52		Get Time of PC	Set Time:Input PC Time
53		Close	Set Time:Close
54	Setting Tool	Execute	Tool:Execute
55		Save List	Tool:Save List
56		Close	Tool:Close
57	Module List	Save List	Module List:Save List
58		Close	Module List:Close
59	Performance	Start Monitoring	Performance:Start
60		Stop Monitoring	Performance:Stop
61		CSV Output	Performance:CSV Output
62		Close	Performance:Close

(Cont.)

Table 8-23 Items in operation record file (3/3)

No.	Menu item	Button	Format
63	DHP Information	Select	DHP info:Select(CP) or (HP)
64		Restart DHP logging	DHP info:Start
65		Stop DHP logging	DHP info:Stop
66		Display DHP trace	DHP info:Trace
67		Close	DHP info:Close
68	AutoSave	Close	AutoSave:Close
69	Task Abort	Execute	Task Abort:OK
70		Close	Task Abort:Close
71	Task Status	Refresh	Task Status:Renew
72		Close	Task Status:Close
73	Initialize Task	Execute	Task ENV:OK
74		Close	Task ENV:Close
75	Set Network(ET.NET)	When opened	Set Network(ET.NET)
76		Route Information	Network(ET.NET):Route Set
77		Write PCs	Network(ET.NET):Write PCs
78		Read PCs	Network(ET.NET):Read PCs
79		File save	Network(ET.NET):File save
80		File open	Network(ET.NET):File open
81		CSV Output	Network(ET.NET):CSV Output
82		Close	Network(ET.NET):Close
83	Display Ethernet Communication of Trace Log (LADDER)	When opened	Ethernet Communication Trace Log(LADDER)
84	Display Ethernet Communication of Trace Log (Socket handler)	When opened	Ethernet Communication Trace Log(Socket handler)
85	Network information	When opened	Network information
86	Event register	When opened	Event Register:Start
87		Close	Event Register:Close
88	Backup	When opened	Backup:Open
89	Restore	When opened	Restore:Open
90	Backup save data comparison	When opened	Compare:Open

8.7 Contents of CPMS files

The following table explains the contents of the CPMS files loaded into the project when you click **Save** or **CPMS Update** in the Project window:

Table 8-24 List of CPMS file contents

No.	File name	Contents
1	OSfile	The CPMS itself, and its system tasks, system area, and so on.
2	OSinitfile	Initial information such as OS tables (TCB, RSUBT, and IRGLBT).
3	LAinitfile1	Management table information for the ladder diagram system.
4	LAinitfile2	Program information for the ladder diagram system.

8.8 Error messages

This section lists the error messages and the action you need to take when you encounter them.

8.8.1 Common

Table 8-25 Common error messages (1/2)

No.	Error message	Action to take
1	Failed to read the file.	(1) If the error occurs when BASE SYSTEM starts: Check the <code>configData.xml</code> file in the same folder as <code>S10VEBASE.exe</code> (2) If the error occurs when you click Save in the Properties window: Check the state of the file <code>C:\S10VE\xxx\projectData.xml</code> (where <code>xxx</code> is the PCs number) (3) If the error occurs when displaying the Project List window: Make sure that the xml file in (2) exists for all PCs numbers set in the <code>C:\S10VE\sysPcsCnt.txt</code> file (the first line in <code>sysPcsCnt.txt</code> is the number of PCs numbers, and the second and subsequent lines are the PCs numbers themselves). (4) If the error occurs in another situation: Check the state of the specified file.
2	Failed to write the file.	(1) If the error occurs when you click Save in the Properties window with Use C-mode selected: Make sure that you are able to write to the folder that contains the <code>S10VEBASE.exe</code> file. (2) If the error occurs in another situation: Check the state of the destination folder specified for the output file.
3	Failed to create a file.	Check the state of the destination folder specified for the output file.
4	File data is invalid.	Check the contents of the specified file.
5	Failed to read the project list file.	Check the state of the <code>C:\S10VE\sysPcsCnt.txt</code> file.
6	Failed to write the project list file.	Check the state of the <code>C:\S10VE\sysPcsCnt.txt</code> file.
7	Failed to read the connection data file.	Check the state of the <code>C:\S10VE\xxx\connectData.xml</code> file (where <code>xxx</code> is the PCs number).
8	Failed to write the connection data file.	Check the state of the <code>C:\S10VE\xxx\connectData.xml</code> file (where <code>xxx</code> is the PCs number).
9	The project is not open.	Repeat the operation with the project open.
10	Connected PCs has not been set.	Set the communication type in the Change PCs window.
11	The CPMS has not been downloaded.	Repeat the operation after downloading the CPMS.
12	Install the RPDP and use it.	Install RPDP.

(Cont.)

Table 8-25 Common error messages (2/2)

No.	Error message	Action to take
13	Failed to write the registry.	Contact the system administrator.
14	Line error	Check the communication paths.
15	Line error (RPC server does not exist.)	Check the communication paths.
16	Failed in setting due to a communication error.	Check the communication paths.
17	Failed in execution due to a communication error.	Check the communication paths.
18	Failed to acquire the PCs number.	Check the communication paths.
19	Failed to reset PCs.	Check the communication paths.
20	Failed to read the IP information file for the BASE SYSTEM.	Check the state of the C:\¥ S10VE¥setipa_S10VE.def file.
21	No IP address is set for the IP information file for the BASE SYSTEM.	Set the communication type again in the Change PCs window.
22	An invalid value was input. Re-enter a correct value.	Enter a correct value.

8. Tools

8.8.2 Project menu

Table 8-26 Project - New

No.	Error message	Action to take
1	Close all windows other than the Properties window and the Project List window, and then execute this operation.	Close all windows except the Properties window and the Project List window.

Table 8-27 Properties window (1/2)

No.	Error message	Action to take
1	Close all windows other than the Properties window and the Project List window, and then execute this operation.	Close all windows except the Properties window and the Project List window.
2	An invalid PCs number was input.	Enter a correct value.
3	No PCs number has been entered. Enter the PCs number.	Enter a PCs number.
4	No comment has been entered. Enter comment.	Enter a comment.
5	Failed to create a project directory.	Check the state of the C:\\$10VE directory.
6	Failed to create a project file.	Check the state of the C:\\$10VE\%xxx folder (where xxx is the PCs number).
7	Failed to create C-mode use information.	Contact the system administrator.
8	Failed to copy the OS file.	Check whether the C:\windows\renix\usr\%rpdp_hce\etc\boot\current\OSfile folder exists. If this folder does not exist, you will need to install CPMS.
9	Failed to copy the OS initial information file.	Check whether the C:\windows\renix\usr\%rpdp_hce\etc\boot\current\OSinitfile folder exists. If this folder does not exist, you will need to install CPMS.
10	Failed to copy the LADDER initial information file 1.	Check whether the C:\windows\renix\usr\%rpdp_hce\etc\boot\current\Lainitfile1 folder exists. If this folder does not exist, you will need to install CPMS.
11	Failed to copy the LADDER initial information file 2.	Check whether the C:\windows\renix\usr\%rpdp_hce\etc\boot\current\Lainitfile2 folder exists. If this folder does not exist, you will need to install CPMS.
12	Execute Save and then execute this operation.	Save the project and then perform the operation again.
13	Failed to invoke svaddsite command.	Check whether the C:\windows\renix\\$10VE\bin\svaddsite.exe file exists. If this file does not exist, you will need to install RPDP.
14	An error occurred in svaddsite command. Error: error-code	Check the error code in Table 8-54. If the error code is unknown, contact the system administrator.

(Cont.)

Table 8-27 Properties window (2/2)

No.	Error message	Action to take
15	Failed to invoke svupdatesiteos command.	Check whether the C:\windows\renix\S10VE\bin\svupdatesiteos.exe file exists. If this file does not exist, you will need to install RPDP.
16	An error occurred in svupdatesiteos command. Error: error-code	Check the error code in Table 8-55. If the error code is unknown, contact the system administrator.
17	Failed to invoke svstedel command.	Check whether the C:\windows\renix\S10VE\bin\svstedel.exe file exists. If this file does not exist, you will need to install RPDP.
18	An error occurred in svstedel command. Error: error-code	Check the error code in Table 8-56. If the error code is unknown, contact the system administrator.
19	Site creation right is not provided.	Perform the operation as the administrator, or as a user who has administrator privileges and belongs to the RPDPusers group.
20	Site update right is not provided.	Perform the operation as the administrator, or as a user who has administrator privileges and belongs to the RPDPusers group.
21	Site deletion right is not provided.	Perform the operation as the administrator, or as a user who has administrator privileges and belongs to the RPDPusers group.
22	Failed to update the IP information file for BASE SYSTEM.	Check the state of the C:\S10VE\setipa_S10VE.def file.
23	Failed to update the IP information file for RPDP.	Check the state of the C:\windows\renix\usr\rpdp_r\etc\setipa.def file.
24	Failed to update rpc_def.e.	Check the state of the C:\S10VE\xxx\xxx_unit\xxx\p\etc\gen\rpc_def.e file (where xxx is the PCs number).

Table 8-28 Project List window (Open)

No.	Error message	Action to take
1	No project is selected.	Select a project and then perform the operation again.
2	Close all windows other than the Properties window and the Project List window, and then execute this operation.	Close all windows except the Properties window and the Project List window.
3	Permission denied to use site.	Perform the operation as the administrator, or as a user who belongs to the RPDPusers group.

Table 8-29 Project List window (Delete)

No.	Error message	Action to take
1	No project is selected.	Select a project and then perform the operation again.
2	Failed to invoke svstidel command.	Check whether the C:\windows\renix\S10VE\bin\svstidel.exe file exists. If this file does not exist, you will need to install RPDP.
3	An error occurred in svstidel command. Error: error-code	Check the error code in Table 8-56. If the error code is unknown, contact the system administrator.
4	Site deletion right is not provided.	Perform the operation as the administrator, or as a user who has administrator privileges and belongs to the RPDPusers group.
5	Cannot delete the project because it is open.	Close the project and then perform the operation again.
6	Failed to delete the project directory.	Check the state of the C:\S10VE\xxx folder (where xxx is the PCs number).

Table 8-30 Close

No.	Error message	Action to take
1	Close all windows other than the Properties window and the Project List window, and then execute this operation.	Close all windows except the Properties window and the Project List window.
2	No project is open.	--

Table 8-31 Set Network window

No.	Error message	Action to take
1	Failed to update the IP information file for the BASE SYSTEM.	Check the state of the C:\S10VE\setipa_S10VE.def file.
2	Right to write the IP information file for the BASE SYSTEM is not provided. Execute this operation as an administrator.	Perform the operation as an administrator.
3	Failed to update the IP information file for the RPDP.	Check the state of the C:\windows\renix\usr\rdp_r\etc\setipa.def file.
4	Right to write the IP information file for the RPDP is not provided. Execute this operation as an administrator.	Perform the operation as an administrator.
5	An error occurred in communication with S10VE.	Check the communication paths.
6	Select a network.	Select a network from the Select Network combo box.
7	Data that cannot be converted to an IP address was found. Such data is shown as initial values.	Enter a correct IP address value.
8	Station number is invalid.	Enter a correct value.
9	Cannot set, because the total course of Ethernet1 and Ethernet2 is over 9.	Make sure that there are no more than nine routes in total.

Table 8-32 Download CPMS window

No.	Error message	Action to take
1	The OSfile has not been loaded.	Click CPMS Update in the Properties window.
2	The OS initial information file has not been loaded.	
3	The LADDER initial information file 1 has not been loaded.	
4	The LADDER initial information file 2 has not been loaded.	
5	Cannot execute with SW STOP. Execute this operation with SW RUN.	Set the CPU RUN/STOP switch of the CPU module to RUN and then perform the operation again.
6	Failed to read data. Check the communication path (including cable connection). Module: <code>xr_rrw_rrb_p</code> Error: <i>error-code</i>	Check the communication paths. Also, check the error code in Table 8-48. If the error code is unknown, contact the system administrator.
7	Failed to transfer data.	Check the error code in Table 8-48. If the error code is unknown, contact the system administrator.
8	Failed to open the UDP communication socket.	If there is no issue with the communication paths, contact the system administrator.
9	Failed to close the UDP communication socket.	If there is no issue with the communication paths, contact the system administrator.
10	Failed in the CPU STOP processing. Module: <code>xr_rrw_stop</code> Error: <i>error-code</i>	Check the communication paths. Also, check the error code in Table 8-48. If the error code is unknown, contact the system administrator.
11	Failed in the CPU reset start. Module: <code>xr_rrw_grstart</code> Error: <i>error-code</i>	Check the communication paths. Also, check the error code in Table 8-48. If the error code is unknown, contact the system administrator.
12	Failed in the CPU reset start. (option module is STOP)	An option module is unable to transition to RUN mode. Contact the system administrator.
13	Failed to save the ROM. Module: <i>module-name</i> Error: <i>error-code</i>	Check the communication paths. Also, check the error code in Table 8-48. If the error code is unknown, contact the system administrator.
14	Failed to save the ROM. (wait time over)	The wait time for the ROM save operation has been exceeded. Contact the system administrator.
15	Failed to save the ROM. (status error: <i>status</i>)	The system is in an abnormal status. Contact the system administrator.
16	Failed to invoke <code>svupdatesiteos</code> command.	Check whether the <code>C:\windows\renix\S10VE\bin\svupdatesiteos.exe</code> file exists. If this file does not exist, you will need to install RPDP.
17	An error occurred in <code>svupdatesiteos</code> command. Error: <i>error-code</i>	Check the error code in Table 8-55. If the error code is unknown, contact the system administrator.
18	Site update right is not provided.	Perform the operation as the administrator, or as a user who belongs to the <code>RPDPusers</code> group.

Table 8-33 End

No.	Error message	Action to take
1	Failed to write data to the operation log.	Check the state of the folder that contains the S10VEBASE . exe file.
2	Operation log write right is not provided.	Check whether you are able to write to the folder that contains the S10VEBASE . exe file.

8.8.3 Online menu

Table 8-34 Change PCs window

No.	Error message	Action to take
1	Cannot execute with CPU STOP. Execute this operation with CPU RUN.	Set the CPU RUN/STOP switch of the CPU module to RUN and then perform the operation again.
2	Failed to update the IP information file for the BASE SYSTEM.	Check the state of the C:\¥S10VE¥setipa_S10VE.def file.
3	Right to write the IP information file for the BASE SYSTEM is not provided. Execute this operation as an administrator.	Perform the operation as an administrator.
4	Failed to update the IP information file for the RPDP.	Check the state of the C:\¥windows¥renix¥usr¥rpd_r¥etc¥setipa.def file.
5	Right to write the IP information file for the RPDP is not provided. Execute this operation as an administrator.	Perform the operation as an administrator.
6	Failed to update rpc_def.e.	Check the state of the C:\¥S10VE¥xxx¥xxx_unit¥xxxcp¥etc¥gen¥rpc_def.e file (where xxx is the PCs number).
7	Failed to read data. Check the communication path (including cable connection). Module: xr_rrw_rrb_p Error: <i>error-code</i>	Check the communication paths. Also, check the error code in Table 8-48. If the error code is unknown, contact the system administrator.
8	Failed to connect PCs. Check the status.	Check the communication paths.
9	Close all windows other than the Change PCs window Properties window, and Project List window, and then execute this operation.	Close the Change PCs window, Properties window, and Project List window.

Table 8-35 Display PCs STATUS and Change PCs STATUS

No.	Error message	Action to take
1	Failed to get PCs status.	Check the communication paths.
2	Failed to change the specified PCs status.	Check the communication paths. Check the state of the PCs.
3	Cannot change the ALARM LED status.	--
4	Cannot change the ERROR LED status.	--
5	Cannot change the STBY LED status.	--
6	Cannot change the RUN LED status.	--
7	The LADDER switch of the CPU module is set to OFF.	Set the LADDER RUN/STOP switch of the CPU module to RUN.
8	The CPU is in the PROTECT state.	Click the Get Status button to acquire the latest status information.
9	The CPU is in the PROTECT OFF state.	
10	The ladder is in the simulation state.	
11	The ladder is in the normal state.	

Table 8-36 Data Send/Receive window

No.	Error message	Action to take
1	Failed to load the module list.	Check the communication paths.
2	Select a module.	Select a module.
3	PCs number in the data does not match the destination PCs number.	Check the specified file.
4	Module identification code in the data does not match the module identification code of the destination.	Check the specified file.
5	Invalid file size	Check the specified file.
6	Cannot write management information.	Check the specified file.
7	Failed to send data.	Check the communication paths.
8	Failed to write NAND.	Check the communication paths.
9	Failed to receive data.	Check the communication paths.
10	An error occurred in data comparison.	Check the communication paths.
11	Data inconsistency. The result was output to the file. File name: <i>file-name</i>	Check the file that was output.

Table 8-37 Backup, Restore, and Backup save data comparison (1/2)

No.	Error message	Action to take
1	Failed in the CPU STOP processing. Module: <i>xr_rrw_stop</i> Error: <i>error-code</i>	Check the communication paths. Also, check the error code in Table 8-48. If the error code is unknown, contact the system administrator.
2	Failed to read data. Check the communication path (including cable connection). Module: <i>module-name</i> Error: <i>error-code</i>	Check the communication paths. Also, check the error code in Table 8-48. If the error code is unknown, contact the system administrator.
3	Failed to transfer data. Check the communication path (including cable connection). Module: <i>module-name</i> Error: <i>error-code</i>	Check the error code in Table 8-48. If the error code is unknown, contact the system administrator.
4	Disc is full.	Replace the disk.
5	Specify a position.	Specify a path in the Position field.
6	The specified drive type is invalid.	Review the path specified in the Position field.
7	Specify a name.	Specify a name in the Name field.
8	The following character cannot be used. /:*?"<>	Review the path specified in the Position field.
9	Continuous '¥' of two or more characters cannot be used.	Review the path specified in the Position field.
10	For the following files exist, the compare can not be performed. Evacuation the file, please execute the compare again. File : file-name	Take remedial action as described in the message, and perform the backup save data comparison operation again.
11	For the following files exist, the restore can not be performed. Evacuation the file, please execute the restore again. File : file-name	Take remedial action as described in the message, and perform the restore operation again.
12	For the following files exist, the backup can not be performed. Evacuation the file, please execute the backup again. File : file-name	Take remedial action as described in the message, and perform the backup operation again.
13	Failed to open the UDP communication socket.	Contact the system administrator.
14	Failed to close the UDP communication socket.	Contact the system administrator.
15	The CPMS has not been downloaded.	Download CPMS and then perform the backup operation again.

Table 8-37 Backup, Restore, and Backup save data comparison (2/2)

No.	Error message	Action to take
16	A folder name is too long.	Review the path and file name specified in the Position and Name fields, and then perform the backup operation again.
17	ROM load went wrong. Error: error-code	Check the error code in Table 8-48. If the error code is unknown, contact the system administrator.
18	The following character cannot be used. /:*?"<> ¥	Review and correct the specified name.
19	No PCs number. Please enter the PCs number	Enter the new PCs number.
20	The PCs number is out of range.	Review and correct the new PCs number you entered.
21	Failed to read the PCs number. It treats as PCs number:0000. Module:xr_rrw_rrb_p Error: error-code	Check the communication paths. Also, check the error code in Table 8-48. If the error code is unknown, contact the system administrator.
22	Failed to read the file. File name: file-name	Check the state of the file shown in the message.
23	Failed to reboot the CPU. Module:xr_rrw_grstart Error: error-code	Check the communication paths. Also, check the error code in Table 8-48. If the error code is unknown, contact the system administrator.
24	Failed to save the ROM. Error: error-code	Check the error code in Table 8-48. If the error code is unknown, contact the system administrator.
25	Failed to write the file. File name: file-name	Check the state of the file shown in the message.
26	The selected drive is not ready.	Wait a while, and then perform the operation again.
27	Select a menu after installing P.P. of BACKUP RESTORE SYSTEM.	Install the BACKUP RESTORE SYSTEM software product.

Table 8-38 Data Clear

No.	Error message	Action to take
1	An error was detected during battery backup memory clear. Memory may not have been cleared.	If there is no issue with the communication paths, contact the system administrator.

8.8.4 Program menu

Table 8-39 Program menu

No.	Error message	Action to take
1	Failed to run the HI-FLOW window program.	Check whether the HI-FLOW SYSTEM software product is installed.
2	Select a menu after installing P.P. of HI-FLOW SYSTEM.	Install the HI-FLOW SYSTEM software product.
3	Failed to run the LADDER window program.	Check whether the LADDER SYSTEM software product is installed.
4	Select a menu after installing P.P. of LADDER DIAGRAM SYSTEM.	Install the LADDER SYSTEM software product.

Table 8-40 Setting Tool window

No.	Error message	Action to take
1	No tool is selected.	Select a tool and then perform the operation again.
2	Cannot run the same tool any more.	--
3	Failed to run the tool.	Check the state of the selected tool.
4	Cannot execute the selected tool.	--

8.8.5 Setting menu

Table 8-41 Set Time window

No.	Error message	Action to take
1	Failed to get PCs time. Gets the local PC time.	Check the communication paths.
2	PCs set time is out of the setting range. Gets the local PC time.	--

8. Tools

8.8.6 RAS menu

Table 8-42 Error log

No.	Error message	Action to take
1	Close the CP error log information window, and then execute this operation.	Close the Display Error log CP window.
2	Close the HP error log information window, and then execute this operation.	Close the Display Error log HP window.

Table 8-43 Performance window

No.	Error message	Action to take
1	Unit measurement time is not input. Enter unit measurement time.	Enter a measurement unit time.
2	Invalid unit measurement time	Enter a correct value.
3	Specify the unit measurement time to be a multiple of sequence cycle (up to 100 times).	Enter a value that is a multiple (a maximum of 100x) of the sequence cycle.
4	No data	Perform the operation again with data displayed in the graph.

Table 8-44 DHP Information window

No.	Error message	Action to take
1	Close the CP-side DHP trace information window, and then execute this operation.	Close the Display DHP trace CP side window.
2	Close the HP-side DHP trace information window, and then execute this operation.	Close the Display DHP trace HP side window.

8.8.7 CPMS Debugger menu

Table 8-45 Task Abort window

No.	Error message	Action to take
1	No task number is input. Enter a task number.	Enter a task number.
2	Enter a task number within a range of 1 to 229.	Enter a number within the permitted range.
3	The first number is not input. When there is only one task number, enter it as the first number.	Enter the number of the first task you want to abort.
4	Enter the first task number in the left box and the last task number in the right box. The first task number is larger than the last task number.	Enter the first task in the left field, and the last task in the right field.

Table 8-46 Initialize Task window

No.	Error message	Action to take
1	The OS initial information file has not been loaded.	Click CPMS Update in the Properties window.
2	Cannot execute with SW STOP. Execute this operation with SW RUN.	Set the CPU RUN/STOP switch of the CPU module to RUN and then perform the operation again.
3	Failed to read data. Check the communication path (including cable connection). Module: <i>xr_rrw_rrb_p</i> Error: <i>error-code</i>	Check the communication paths. Also, check the error code in Table 8-48. If the error code is unknown, contact the system administrator.
4	Failed to transfer data.	Check the error code in Table 8-48. If the error code is unknown, contact the system administrator.
5	Failed to open the UDP communication socket.	If there is no issue with the communication paths, contact the system administrator.
6	Failed to close the UDP communication socket.	If there is no issue with the communication paths, contact the system administrator.
7	Failed in the CPU STOP processing. Module: <i>xr_rrw_stop</i> Error: <i>error-code</i>	Check the communication paths. Also, check the error code in Table 8-48. If the error code is unknown, contact the system administrator.
8	Failed in the CPU reset start. Module: <i>xr_rrw_grstart</i> Error: <i>error-code</i>	Check the communication paths. Also, check the error code in Table 8-48. If the error code is unknown, contact the system administrator.
9	Failed in the CPU reset start. (option module is STOP)	An option module is unable to transition to RUN mode. Contact the system administrator.
10	Failed to save the ROM. Module: <i>module-name</i> Error: <i>error-code</i>	Check the communication paths. Also, check the error code in Table 8-48. If the error code is unknown, contact the system administrator.
11	Failed to save the ROM. (wait time over)	The wait time for the ROM save operation has been exceeded. Contact the system administrator.
12	Failed to save the ROM. (status error: <i>status</i>)	The system is in an abnormal status. Contact the system administrator.

8.8.8 RPC error messages

Table 8-47 RPC error messages

No.	Error message	Action to take
1	Line error (A signal was received.)	If there is no issue with the communication paths, contact the system administrator.
2	Line error (A timeout error occurred.)	If there is no issue with the communication paths, contact the system administrator.
3	Line error (The RPC server does not exist.)	If there is no issue with the communication paths, contact the system administrator.
4	Line error (The RPC server is disconnected.)	If there is no issue with the communication paths, contact the system administrator.
5	Line error (The connection is reset.)	If there is no issue with the communication paths, contact the system administrator.
6	Line error (The RPC server is closed.)	If there is no issue with the communication paths, contact the system administrator.
7	Line error (A timeout error occurred during inter-PU communication. Check the status of each PU, and then retry operation.)	If there is no issue with the communication paths, contact the system administrator.
8	Line error (The line port is busy. Wait until the use by other users ends, and then retry operation.)	Wait until the other user has finished using the line port, and then perform the operation again.
9	Line error (An invalid socket was specified.)	If there is no issue with the communication paths, contact the system administrator.
10	Line error (Failed to generate a socket.)	If there is no issue with the communication paths, contact the system administrator.
11	Line error (Failed to allocate the memory.)	If there is no issue with the communication paths, contact the system administrator.
12	Line error (The network is disconnected.)	If there is no issue with the communication paths, contact the system administrator.
13	Line error (The network connection interface is down.)	If there is no issue with the communication paths, contact the system administrator.
14	Line error (Failed to load the port number.)	If there is no issue with the communication paths, contact the system administrator.
15	Line error (Failed to load the IP address.)	If there is no issue with the communication paths, contact the system administrator.
16	Line error (Failed to attach the shared memory.)	If there is no issue with the communication paths, contact the system administrator.
17	Line error (A fatal error occurred.)	If there is no issue with the communication paths, contact the system administrator.
18	Line error (RPC library error (rc=%d))	If there are no issues with the CPMS and RPDP versions or the communication paths, contact the system administrator [#] .

[#]: Interpreting rc values in RPC library errors:

23: There is no function corresponding to CPMS.

Other value: The Windows socket error code output by the WSAGetLastError function of the Windows API.

8. Tools

8.8.9 Error codes

Table 8-48 xr_rrw_rpl_p, xr_rrw_rrb_p, xr_rrw_stop, and xr_rrw_grstart

Error	Nature of error
H11	Socket error
H12	IP address error
H14	Storage area address error (0 specified, dta)
H15	Storage area address error (0 specified, wka)
H16	Size error (0 KB or less, or 16 KB or more)
H17	Size error (non-longword size)
H3	Remote adapter type error
H4	Unable to allocate memory for frame creation
H5	Unable to send data
H6	Response timeout error
H7	Maximum number of retries exceeded while waiting for response (cable disconnected)
H8	Unable to receive data
H18	Storage area address error (0 specified, dmaia)
H19	Storage area address error (0 specified, reta)
H8000000X	Error reported in response (status code in CPU control header) X: Status code, 4: $\mu\Sigma$ NETWORK-1000 network not configured
HFFFFFFFA	Cable disconnected after CPU STOP, or incorrect station number
HFFFFFFFE	Cable disconnected before CPU STOP
HFFFFFFF	Environment file error

Table 8-49 svaddsite

Error	Nature of error
1	There is an error in the definition file.
2	The specified system construction environment could not be found.
3	The project file could not be updated.

Table 8-50 svupdatesiteos

Error	Nature of error
1	Abnormal termination
2	Data cannot be updated because the addresses of the user area of the base site overlap with those of the destination.
3	Data cannot be updated because the name of a user resource of the base site is the same as the name of a user resource at the destination.

Table 8-51 svstedel

Error	Nature of error
1	The site could not be deleted.
2	The project file could not be updated.

This page is intentionally left blank.

9. Settings

9.1 Setting items

Table 9-1 and Table 9-2 list the settings that are available when using the S10VE system.

Table 9-1 Hardware settings

Module name	Setting item	Description of setting	Reference
CPU module	CPU RUN/STOP switch	Set using the CPU RUN /STOP switch of the CPU module. - To place the CPU in RUN mode: RUN - To place the CPU in STOP mode: STOP	See 5.3
	LADDER RUN/STOP switch	Set using the LADDER RUN/STOP switch of the CPU module. - To run the ladder program: RUN - To stop the ladder program: STOP	See 5.3
	Ethernet station number setting switch	Use the ET ST.No. switch on the CPU module to set the Ethernet station number. - To use your own IP address settings: U = 0 to F, L = 0 to E - To use the following fixed IP addresses: U = F, L = F ET1 IP address: 192 . 192 . 192 . 1 ET2 IP address: 192 . 192 . 193 . 1 Note: If you will not be using Ethernet communication, set U = F and L = F. This is to allow the PADT to connect for maintenance purposes.	See 5.3
	Connection of primary battery	Connect the primary battery. Open the cover on the left side of the CPU module, and connect the cable for the primary battery to its connector.	See 6.8
Option modules	General	For details on the settings for option modules, see the documentation that accompanies each module [#] .	--

#: - S10VE User's Manual Option OD.RING (LQE510-E) (manual number SEE-1-101)

- S10VE User's Manual Option J.NET (LQE540-E) (manual number SEE-1-102)

- S10VE User's Manual Option D.NET (LQE770-E) (manual number SEE-1-103)

- S10VE User's Manual Option FL.NET (LQE702-E) (manual number SEE-1-104)

- S10VE User's Manual Option ET.NET (LQE260-E) (manual number SEE-1-105)

Table 9-2 Software settings

Unit name	Setting item	Description of setting	Reference
CPU unit	PI/O installation	Set whether PI/O modules are to be installed in the CPU unit. - When installing PI/O modules: Used - When not installing PI/O modules: No used	See 9.3.1
	Partition setting	Set the I/O slots (partitions) into which I/O modules are to be installed. - If the total number of I/O points of PI/O modules connected by remote I/O exceeds 2,048: FIX - All other situations: FREE	See 9.3.2
	Output hold setting for digital output module	Set the output state to be adopted by the digital output modules installed in the CPU mount base when an error occurs in the CPU module. - To turn off output when an error occurs: RESET - To retain the values that were in effect immediately prior to the error occurring: HOLD	See 9.3.3
	Number of I/O points	Set the number of I/O points allocated to each slot on the CPU mount base. If the system will incorporate PI/O modules with different numbers of I/O points, set the highest number among the installed PI/O modules.	See 9.3.4
	Ladder synchronous/asynchronous mode setting	Set whether to synchronize remote I/O signals with ladder processing. To synchronize remote I/O signals with ladder processing: Ladder synchronous mode To not synchronize remote I/O signals with ladder processing: Ladder asynchronous mode	See 9.3.5
	Remote I/O optical adapter connection setting	Use this setting when incorporating remote I/O optical adapters into the system to extend the length of the remote I/O cables. When connecting optical adapters: Connect When not connecting optical adapters: No-connect	See 9.3.6
	Number of remote I/O points	Set the number of remote I/O points. Select 64, 128, 256, 512, 1,024, 1,536, or 2,048 remote I/O points as suits your environment.	See 9.3.7
	Analog module and pulse counter module settings	Registers the module installation addresses in the data area (PI/O register area). Use this setting if you want to use an analog module in MODE2, or you want to use a pulse counter module. Skip this setting if you want to use an analog module in MODE1.	See 9.4
Time setting	Set the system time.	See 8.4.5.1	

For details on how to configure a module installed in the PI/O unit, see the manual for that module:

- S10mini Hardware Manual I/O Modules (manual number SME-1-114)
- S10mini Hardware Manual D.Station (manual number SME-1-119)
- HSC-2100 Hardware Manual I/O Modules (manual number SME-1-126)

9.2 I/O number structure and scope of allocation

An I/O number identifies the I/O type of a PI/O module and the slot in which it is installed.

Each I/O number is made up of five alphanumeric characters. The following figure explains the meaning of each digit:

■ Structure of I/O number

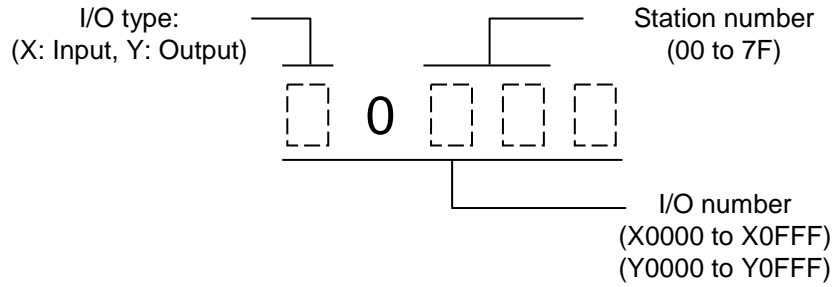

Note: I/O numbers are within the range from 0000 to 0FFF. However, station numbers are limited to a range from 00 to 7F.

■ Scope of allocation

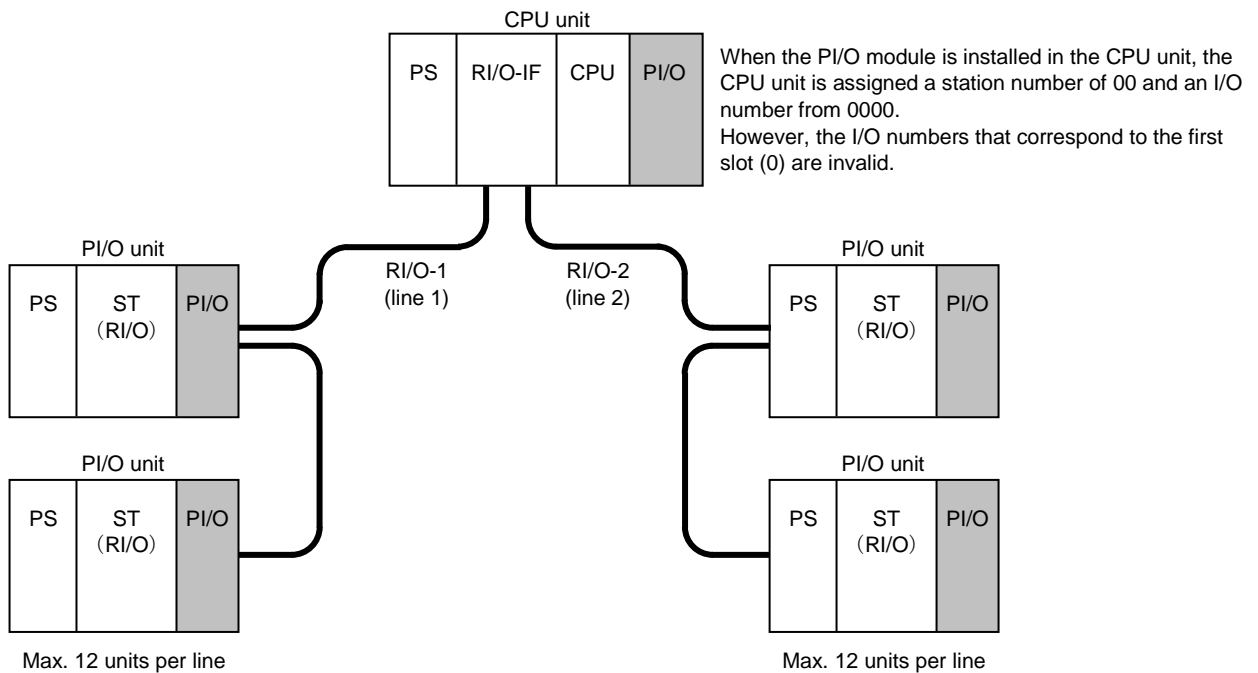

Number of I/O slots on PI/O unit mount base	Range of station numbers to be set	
	RI/O-1#	RI/O-2
2	00 to 3E	40 to 7E
4	00 to 3C	40 to 7C
8	00 to 38	40 to 78

#: When a PI/O module is installed in the CPU unit, the CPU unit will have the station number 00. Set the station numbers of PI/O units connected to RI/O-1 (line 1) so as not to conflict with the station number of the CPU unit.

9.3 Setting PI/O and remote I/O

The following explains how to set up PI/O and remote I/O in the CPU unit.

When installing an HSC-1000 PI/O module in the CPU unit, set it up by following the steps in sections 9.3.1 to 9.3.7.

■ Setting up PI/O and remote I/O for the CPU unit

Use the ladder diagram system tool to set up the PI/O and remote I/O for the CPU unit. For details on how to connect and start this tool, see the *SIOVE Software Manual Operation Ladder Diagram System for Windows®* (manual number SEE-3-131).

9.3.1 PI/O installation setting

Perform this setting when installing a PI/O module in the CPU unit.

If you specify Used, a station number and I/O numbers are assigned to the CPU unit as follows:

- The first station number (00) is assigned to the CPU unit. However, some I/O numbers are invalid. For details, see 9.3.4 *I/O point number setting*.
- I/O numbers are allocated automatically within a range determined by the number of I/O slots in the mount base, the partition setting, and the number of I/O points.

If you specify No used, the CPU unit is not assigned a station number or I/O numbers.

For details on how to perform this setting, see the *SIOVE Software Manual Operation Ladder Diagram System for Windows®* (manual number SEE-3-131).

9. Settings

9.3.2 Partition setting (FIX/FREE)

For most circumstances, FREE is the appropriate partition setting. However, you will need to set FIX if the PI/O modules connected by remote I/O have more than 2,048 I/O points in total. The FIX setting allows a maximum of 2,048 input I/O points, and a maximum of 2,048 output I/O points.

- The FREE setting removes the limitation that designates each I/O slot on the CPU mount base or PI/O mount base as either an input or output slot. Each slot is assigned an I/O number for input purposes and another for output purposes (X0AAA and Y0AAA). This allows you to specify the I/O number that is appropriate for the PI/O module you are installing.
- The FIX setting reserves I/O slots 1 to 3 on the CPU mount base for input modules, and slots 4 to 7 for output modules. Similarly, the I/O slots on the left half of the PI/O mount base are reserved for input modules, and those on the right half are reserved for output modules. I/O numbers are assigned to the input slots in the format X0AAA, and to output slots in the format Y0AAA.

■ CPU unit partition setting

For details on how to set the partition setting of the CPU unit, see the *SIOVE Software Manual Operation Ladder Diagram System for Windows*® (manual number SEE-3-131).

■ Differences between FIX and FREE settings

Table 9-3 FIX and FREE settings

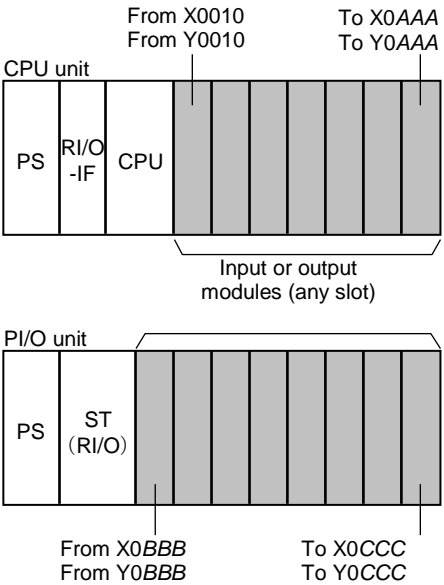
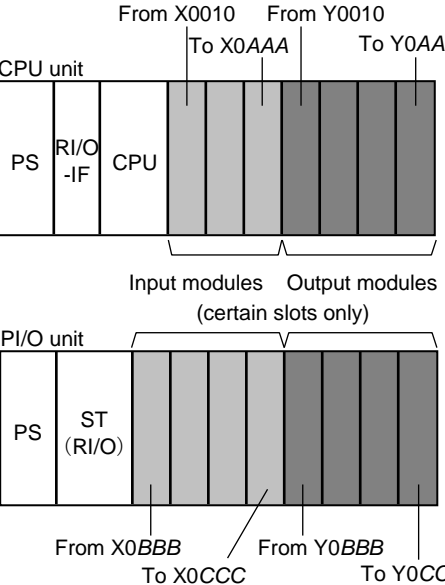
Setting item	FREE	FIX																
<p>PI/O module installation slot</p>	 <p>If the PI/O module is not installed in the CPU unit, X0BBB and Y0BBB are X0000 and Y0000 respectively.</p>	 <p>If the PI/O module is not installed in the CPU unit, X0BBB and Y0BBB are X0000 and Y0000 respectively.</p>																
<p>I/O number allocation</p>	<p>I/O numbers for input</p> <table border="1" data-bbox="391 1149 869 1216"> <tr> <td>X0010 to X0AAA</td> <td>(CPU unit)</td> </tr> <tr> <td>X0BBB to X0CCC</td> <td>(PI/O unit)</td> </tr> </table> <p>and</p> <p>I/O numbers for output</p> <table border="1" data-bbox="391 1283 869 1350"> <tr> <td>Y0010 to Y0AAA</td> <td>(CPU unit)</td> </tr> <tr> <td>Y0BBB to Y0CCC</td> <td>(PI/O unit)</td> </tr> </table> <p>are both allocated.</p>	X0010 to X0AAA	(CPU unit)	X0BBB to X0CCC	(PI/O unit)	Y0010 to Y0AAA	(CPU unit)	Y0BBB to Y0CCC	(PI/O unit)	<p>Input I/O numbers are allocated to slots 1 to 3 of the CPU unit and to the left half of the PI/O unit, as follows:</p> <table border="1" data-bbox="930 1238 1401 1305"> <tr> <td>X0010 to X0AAA</td> <td>(CPU unit)</td> </tr> <tr> <td>X0BBB to X0CCC</td> <td>(PI/O unit)</td> </tr> </table> <p>Output I/O numbers are allocated to slots 4 to 7 of the CPU unit and to the right half of the PI/O unit, as follows:</p> <table border="1" data-bbox="930 1440 1401 1507"> <tr> <td>Y0010 to Y0AAA</td> <td>(CPU unit)</td> </tr> <tr> <td>Y0BBB to Y0CCC</td> <td>(PI/O unit)</td> </tr> </table>	X0010 to X0AAA	(CPU unit)	X0BBB to X0CCC	(PI/O unit)	Y0010 to Y0AAA	(CPU unit)	Y0BBB to Y0CCC	(PI/O unit)
X0010 to X0AAA	(CPU unit)																	
X0BBB to X0CCC	(PI/O unit)																	
Y0010 to Y0AAA	(CPU unit)																	
Y0BBB to Y0CCC	(PI/O unit)																	
X0010 to X0AAA	(CPU unit)																	
X0BBB to X0CCC	(PI/O unit)																	
Y0010 to Y0AAA	(CPU unit)																	
Y0BBB to Y0CCC	(PI/O unit)																	
<p>Key features</p>	<ul style="list-style-type: none"> - Input modules and output modules can be installed in any slot. - Input and output modules can be interchanged even after I/O allocation. 	<ul style="list-style-type: none"> - Input modules and output modules can only be installed in certain slots. 																

9. Settings

9.3.3 Output hold setting for digital output modules

This setting determines whether the output of the digital output modules in each unit is reset or held when an error occurs in the CPU module. Errors that trigger this scenario include errors that prevent ladder logic from operating in the CPU module, and disconnection of a remote I/O line in a PI/O unit.

The RESET setting turns output off, and the HOLD setting retains the output value that was in effect immediately before the error occurred.

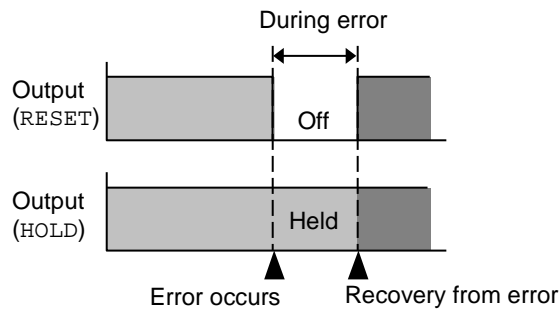

Note: The output hold setting is only valid for digital output modules. Analog output modules always operate as if HOLD were specified.

■ Setting the digital output module hold setting for the CPU unit

For details on how to perform this setting, see the *SIOVE Software Manual Operation Ladder Diagram System for Windows®* (manual number SEE-3-131).

9.3.4 I/O point number setting

Set the number of I/O points of the installed PI/O modules, or of the PI/O modules you intend to install if the number is greater.

If the system will incorporate PI/O modules with different numbers of I/O points, set the highest number among the installed PI/O modules. For example, if the system has 16 point modules and 32 point modules, set 32 as the number of I/O points. In this case, I/O numbers for 32 I/O points are allocated to both module types. However, the 16 point modules only use the first 16 numbers, with the latter 16 remaining unassigned. In contrast, if you set 16 as the number of I/O points, I/O numbers are only assigned to the first 16 I/O points of the 32 point modules.

■ Setting the number of I/O points of the CPU unit

For details on how to set the number of I/O points of the CPU unit, see the *SIOVE Software Manual Operation Ladder Diagram System for Windows®* (manual number SEE-3-131).

■ Relationship between I/O points and I/O numbers

- The following settings determine the prefix and range of the allocated I/O numbers:

Prefix: The first three digits are determined by the station number setting.

Range: Numbers are automatically allocated based on the number of I/O slots in the mount base, the number of I/O points, and the partition setting.

- I/O numbers are assigned to all slots, even those without modules installed. This means that adding or removing modules does not cause I/O numbers to be reallocated.

- The I/O number assigned to each input or output point is determined by the partition setting, as follows:

FREE: Input I/O numbers (X0AAA) and output I/O numbers (Y0AAA) are both allocated, and the system can select whichever of these I/O numbers is applicable (Table 9-4).

FIX: I/O slots are exclusively designated for input modules or output modules. This means that each point is assigned one I/O number, for either input or output depending on the designation of the I/O slot. Input I/O numbers are in the format X0AAA, and output I/O numbers are in the format Y0AAA (Table 9-5).

**Table 9-4 CPU unit I/O number allocation and I/O points used
(Partition setting: FREE, First I/O number: 0000)**

No.	I/O points	I/O numbers							I/O points used per unit	
1	16 points	Slot number → 1	2	3	4	5	6	7	X area (input): 128 points Y area (output): 128 points Note that the first 16 points (0000 to 000F) are invalid for input and output.	
		I/O number allocation	0010 to 001F	0020 to 002F	0030 to 003F	0040 to 004F	0050 to 005F	0060 to 006F	0070 to 007F	
2	32 points	Slot number → 1	2	3	4	5	6	7	X area (input): 256 points Y area (output): 256 points Note that the first 32 points (0000 to 001F) are invalid for input and output.	
		I/O number allocation	0020 to 003F	0040 to 005F	0060 to 007F	0080 to 009F	00A0 to 00BF	00C0 to 00DF	00E0 to 00FF	
3	64 points	Slot number → 1	2	3	4	5	6	7	X area (input): 512 points Y area (output): 512 points Note that the first 64 points (0000 to 003F) are invalid for input and output.	
		I/O number allocation	0040 to 007F	0080 to 00BF	00C0 to 00FF	0100 to 013F	0140 to 017F	0180 to 01BF	01C0 to 01FF	
4	128 points	Slot number → 1	2	3	4	5	6	7	X area (input): 1,024 points Y area (output): 1,024 points Note that the first 128 points (0000 to 007F) are invalid for input and output.	
		I/O number allocation	0080 to 00FF	0100 to 017F	0180 to 01FF	0200 to 027F	0280 to 02FF	0300 to 037F	0380 to 03FF	

Note: Each slot is assigned input I/O numbers (X0AAA) and output I/O numbers (Y0AAA). However, this table omits the X and Y prefixes, showing only the number component (0AAA).

Example: Interpret 0000 to 000F as X0000 to X000F and Y0000 to Y000F.

**Table 9-5 CPU unit I/O number allocation and I/O points used
(Partition setting: FIX, First I/O number: 0000)**

No.	I/O points	I/O numbers	I/O points used per unit
1	16 points	<p>Slot number → 1 2 3 4 5 6 7</p> <p>I/O number allocation</p> <p>Input I/O slots Output I/O slots</p>	<p>X area (input): 64 points Y area (output): 64 points Note that the first 16 points on the input side (X0000 to X000F) are invalid addresses.</p>
2	32 points	<p>Slot number → 1 2 3 4 5 6 7</p> <p>I/O number allocation</p> <p>Input I/O slots Output I/O slots</p>	<p>X area (input): 128 points Y area (output): 128 points Note that the first 32 points on the input side (X0000 to X001F) are invalid addresses.</p>
3	64 points	<p>Slot number → 1 2 3 4 5 6 7</p> <p>I/O number allocation</p> <p>Input I/O slots Output I/O slots</p>	<p>X area (input): 256 points Y area (output): 256 points Note that the first 64 points on the input side (X0000 to X003F) are invalid addresses.</p>
4	128 points	<p>Slot number → 1 2 3 4 5 6 7</p> <p>I/O number allocation</p> <p>Input I/O slots Output I/O slots</p>	<p>X area (input): 512 points Y area (output): 512 points Note that the first 128 points on the input side (X0000 to X007F) are invalid addresses.</p>

The arrow indicates the boundary between input and output slots imposed by the FIX partition setting. Input I/O numbers (X) are allocated to slots 1 to 3, and output I/O numbers (Y) are assigned to slots 4 to 7.

9.3.5 Ladder synchronous/asynchronous mode setting

The CPU module provides a function that allows remote I/O to be synchronous or asynchronous with ladder logic processing.

In asynchronous mode, ladder processing and remote I/O transfer operate independently, allowing remote I/O transfer to complete in the shortest possible time. However, this can mean that the PI/O memory changes state during a given sequence cycle of ladder processing, potentially resulting in ladder processing that does not behave as intended.

In synchronous mode, the system does not transition to the next remote I/O transfer operation until ladder processing has completed in a sequence cycle. This means that ladder processing always proceeds as expected without the possibility of the PI/O memory state changing during a sequence cycle, but results in slower remote I/O transfer cycles as the size of the ladder program increases.

■ Operation in asynchronous mode

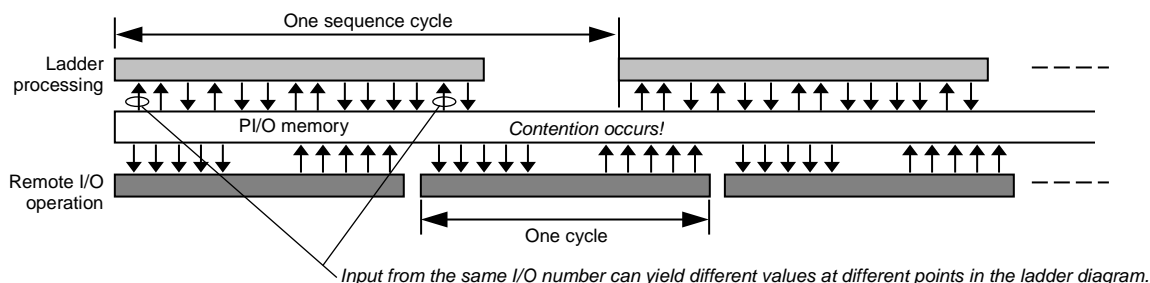

■ Operation in synchronous mode

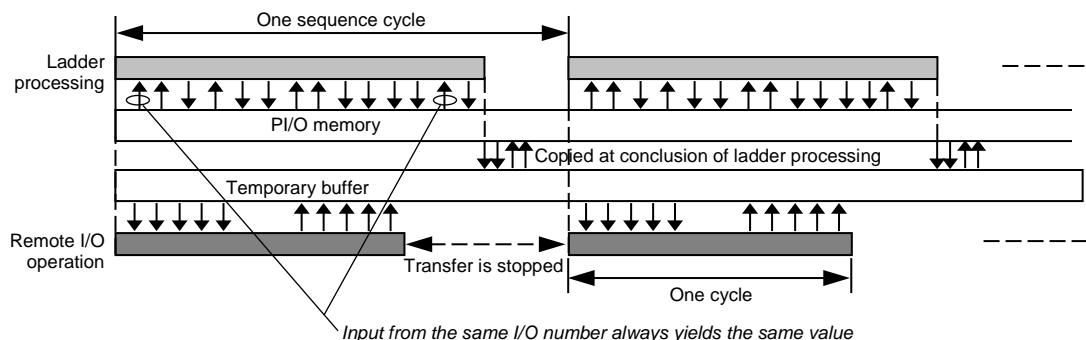

Note: In synchronous mode, a sequence cycle cannot be shorter than a remote I/O cycle.

■ Setting synchronous or asynchronous mode

For details on how to enable synchronous or asynchronous mode, see the *SIOVE Software Manual Operation Ladder Diagram System for Windows®* (manual number SEE-3-131).

9. Settings

9.3.6 Remote I/O optical adapter connection setting

You can extend the length of remote I/O lines to a maximum of 3.3 km by connecting remote I/O optical adapters (model: LQZ410) to the remote I/O lines of the RI/O-IF module.

- When connecting a remote I/O optical adapter, specify Connect.
- When not connecting a remote I/O optical adapter, specify No-connect.

■ How to set whether an optical adapter is connected

For details on the setting to make when connecting an optical adapter, see the *SIOVE Software Manual Operation Ladder Diagram System for Windows®* (manual number SEE-3-131).

9.3.7 Remote I/O point setting

The remote I/O function can handle a maximum of 2,048 input points and 2,048 output points. However, if you only intend to use a small number of I/O points, scanning all 2,048 points makes each communication operation take longer, and timeouts occur in relation to unallocated I/O numbers. This extends communication time by an amount equivalent to the time required to detect these timeouts.

For this reason, a number of tiers are defined for remote I/O points that allow you to select a smaller number when applicable. By selecting the smallest number of points that meets your needs, you can reduce communication time and operate an efficient system.

■ Setting the number of remote I/O points

For details on how to set the number of remote I/O points, see the *SIOVE Software Manual Operation Ladder Diagram System for Windows®* (manual number SEE-3-131).

Note: When an I/O unit is connected to RI/O-2 (line 2), you must select 1,536 or 2,048.

The 64 and 1,024 settings only work with RI/O-1 (line 1).

9.4 Analog module and pulse counter module settings

Use the ladder diagram system tool to configure the analog module and pulse counter module when:

- You want to enable the MODE2 setting in an analog module
- You want to use a pulse counter module

You can skip this setting if you want to use the analog module with the MODE1 setting.

■ Settings for analog modules and pulse counter modules

For details on how to perform these settings, see the *SIOVE Software Manual Operation Ladder Diagram System for Windows*® (manual number SEE-3-131).

This page is intentionally left blank.

10. Indicator

10.1 Overview

An indicator is provided on the front panel of the S10VE CPU module. This indicator provides the user with information about the operating status of the S10VE.

You can also use the menu keys on the indicator panel to perform a number of tasks, including displaying the error state of the S10VE system and checking various settings.

Table 10-1 shows the names and functions of the indicator and menu keys.

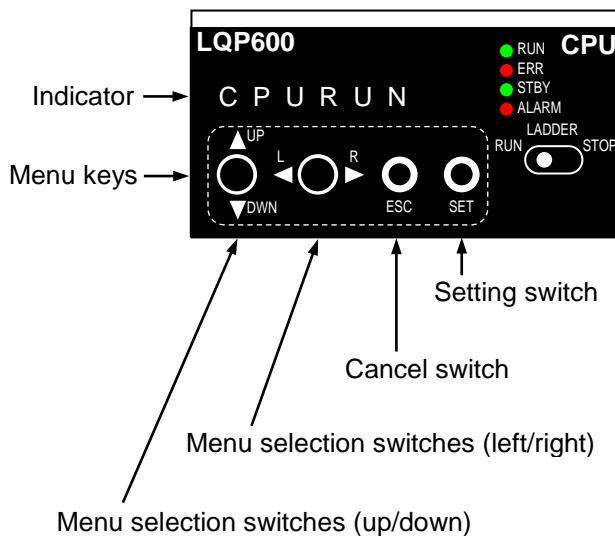

Figure 10-1 Indicator and menu keys

Table 10-1 Names and functions of indicator and menu keys

Name		Function
Indicator		Shows the operating status of the S10VE. You can use the menu keys to cycle through the displayed information.
Menu keys	Menu selection switches (up/down) ▲UP/▼DOWN	Changes the information displayed by the indicator. See 10.3 <i>Indicator display transitions</i> .
	Menu selection switches (left/right) ◀L/▶R	
	Cancel switch ESC	
	Setting switch SET	

10.2 Information displayed on indicator

Table 10-2 lists the information that can be displayed on the indicator.

Table 10-2 Information displayed on indicator

No.	Description	Display example
1	Home position display	L D R R U N
2	Firmware version display	F W V E R
3	OS version display	o S V E R
4	CPU module error status display	E R R S T S
5	Indicator pattern display	L E D C H K
6	Access to extended menu	E X M E N U
7	Ladder mode display	L D N / S
8	PCs number display	P C S N o
9	ON status E coil display	E C o I L
10	Exit on-board menu	E X E X T

10.3 Indicator display transitions

You can use the menu keys to change the displayed information on the indicator. Figure 10-2 and Figure 10-3 show the display transitions that occur when you press the menu keys. For details about each function, see the reference location shown next to its name.

Relationship between symbols and switch actions

- ▲UP ... Press the ▲UP/▼DOWN toggle switch towards the ▲UP position.
- ▼DOWN ... Press the ▲UP/▼DOWN toggle switch towards the ▼DOWN position
- ▶R ... Press the ◀L/▶R toggle switch towards the ▶R position.
- ◀L ... Press the ◀L/▶R toggle switch towards the ◀L position.
- SET ... Press the SET switch.
- ESC ... Press the ESC switch.

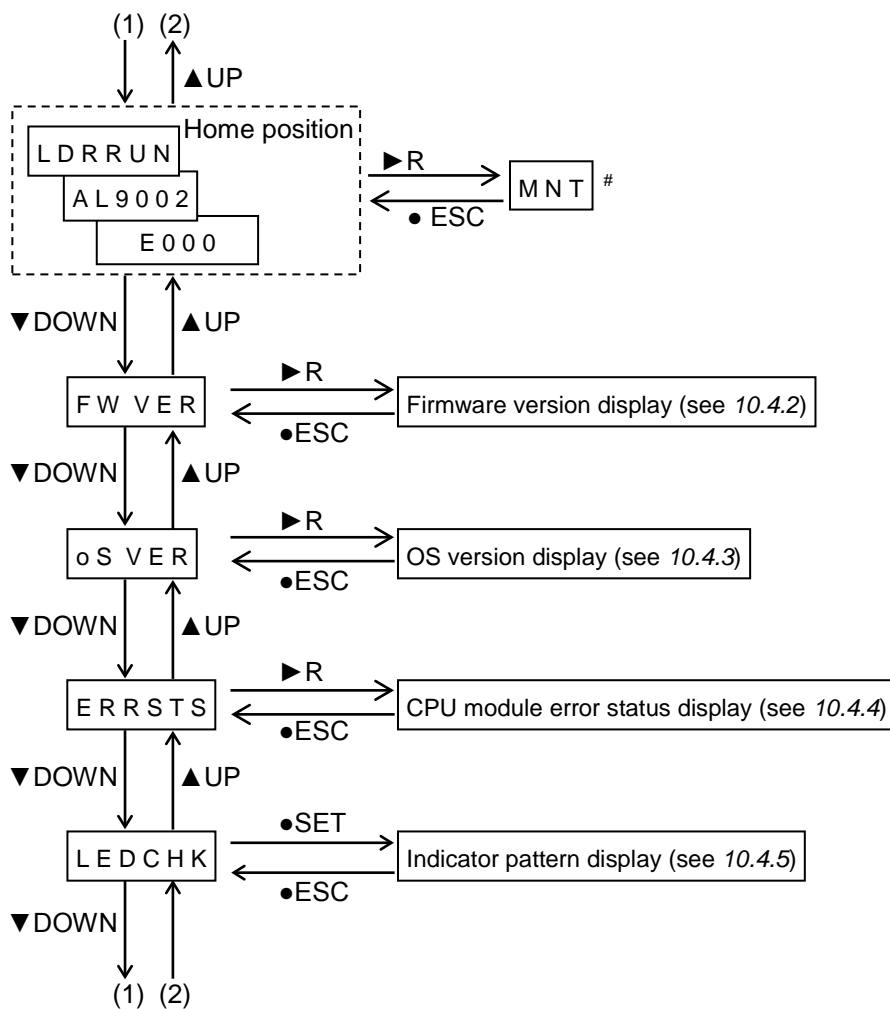

#: Maintenance mode for Hitachi use (not disclosed to users)

Figure 10-2 Indicator display transitions when CPU module is in STOP mode

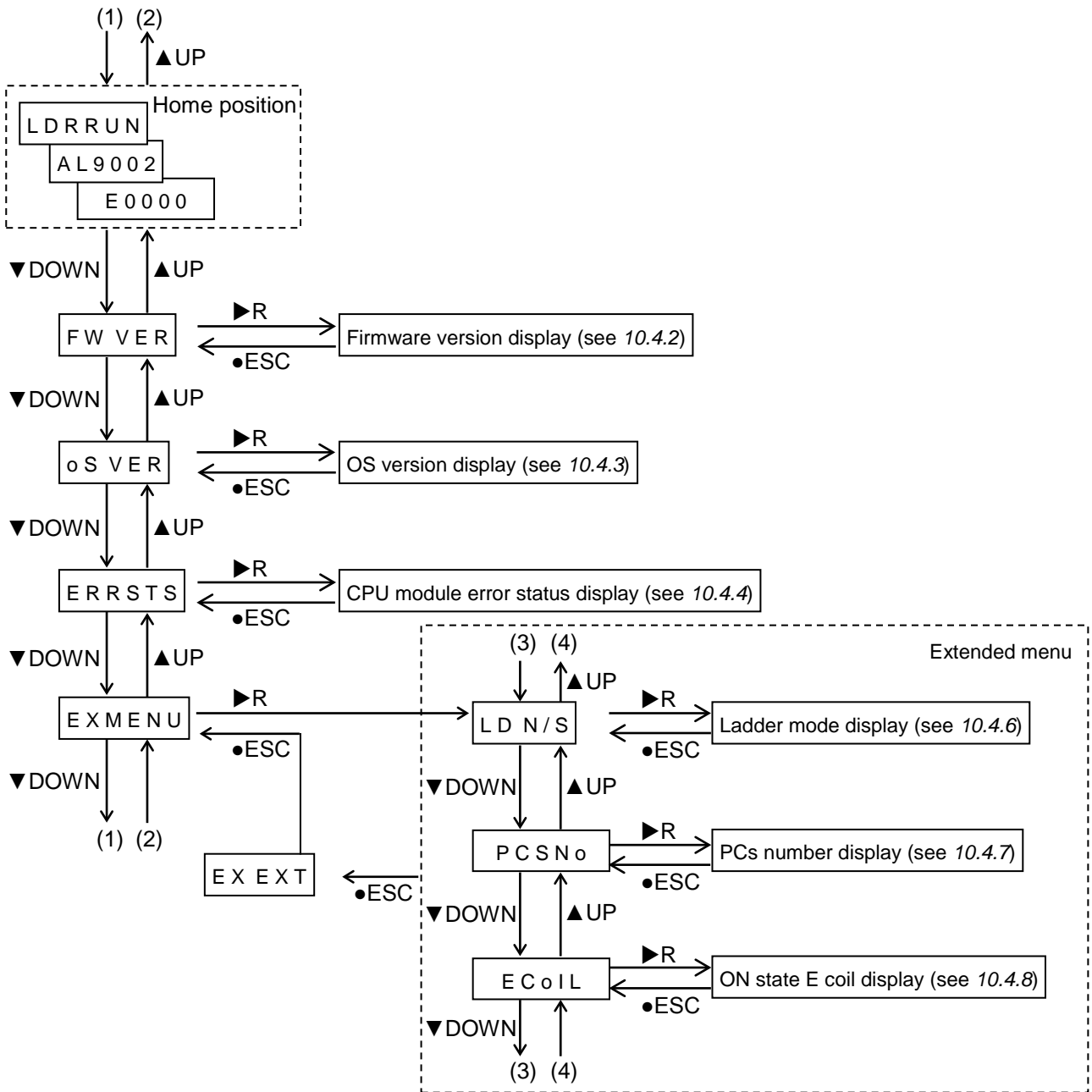

Figure 10-3 Indicator display transitions when CPU module is in RUN mode

10.4 Explanation of displayed information

10.4.1 Home position display

The home position is where the indicator displays the CPU module operating status, the E coil status, the CPU module alarm status, and the error status of option modules. The indicator automatically transitions to the next status display after two seconds. If a serious error occurs, the indicator displays the error code of the serious error.

Figure 10-4 shows the display transitions at the home position.

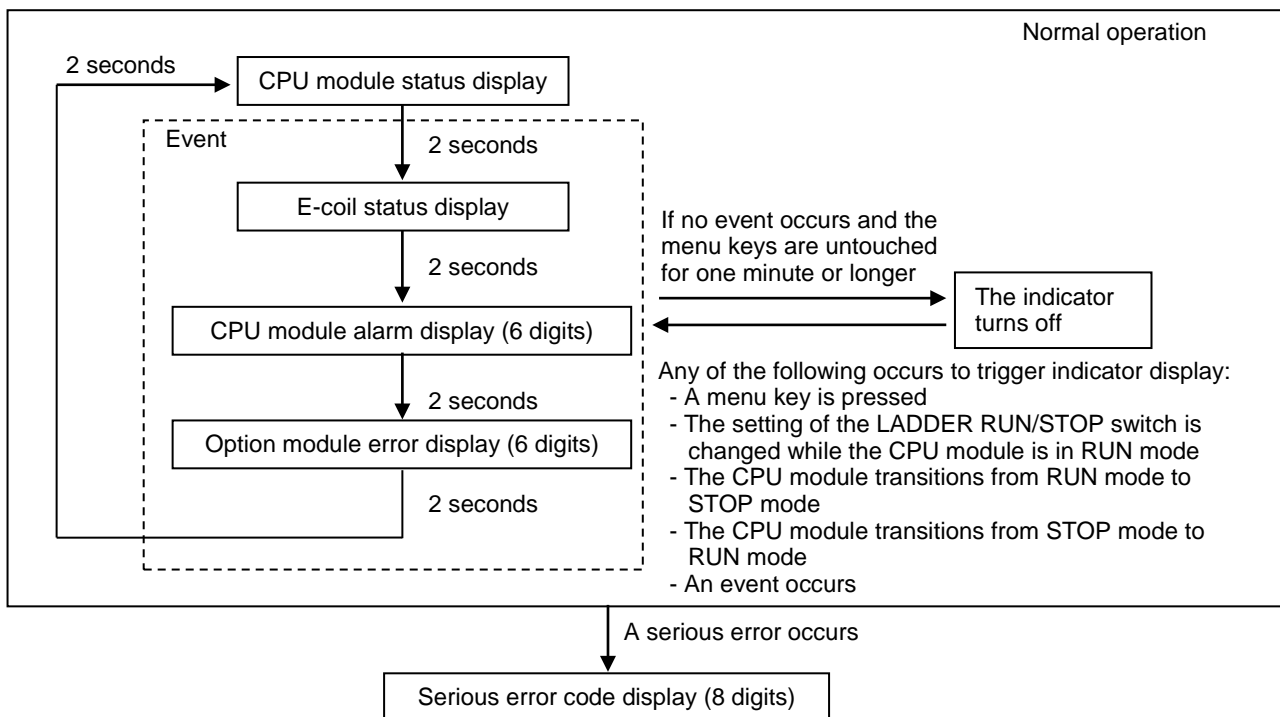

Figure 10-4 Display transitions at home position

(1) CPU module status display

In this state, the indicator displays the state of the CPU module as explained in Table 10-3. For details about CPU module states, see *Chapter 11. Operation*.

Table 10-3 CPU module status display

No.	Display	Description
1	C P U S T P	The CPU is in STOP mode.
2	C P U R U N	The CPU is in RUN mode.
3	L D R R U N	Ladder logic is in RUN mode.
4	L D R S T P	Ladder logic is in STOP mode.

10. Indicator

- (2) E coil status display (available when the CPU module is in RUN mode)

The system detects the E coil (display range from E0000 to E01FF) and sequentially displays each case of the E coil being ON. If the E coil is ON at multiple locations, the system displays the next case after cycling through the other events. For example, if E01FC is ON, the indicator displays E 0 1 F C.

- (3) CPU module alarm display

Table 10-4 shows the information displayed on the indicator when a minor error has occurred.

Table 10-4 Minor error status display

Display	Description
A L 9 0 0 2	Low primary battery voltage detected

- (4) Option module error display

The indicator displays the error state of the option modules. If an error has occurred, the indicator displays an error code consisting of six alphanumeric characters. It displays, one at a time, the error codes for a maximum of 16 cases. If more than one error has occurred, the indicator displays the next error code after going through the other events. Table 10-5 shows the information displayed on the indicator:

Table 10-5 Option module error display

Display	Description
X X Y Y Y Y	An error was detected in an option module. For details on the action you need to take, see <i>Chapter 13. Troubleshooting.</i>

- (5) Serious error code display

When the CPU module detects a serious error, the indicator displays the error code consisting of eight alphanumeric characters. The serious error code remains displayed in the home position until the power is turned off or the CPU module is reset. Table 10-6 shows the information displayed on the indicator:

Table 10-6 Serious error code display

Display	Description
E C F = m m n n n n n n	The error code of an error detected by the firmware of the CPU module. The display alternates between E C F = m m and n n n n n n approximately every two seconds. The error code is the string of eight alphanumeric characters starting with m m and ending with n n n n n n. For details on the action you need to take, see <i>Chapter 13. Troubleshooting.</i>
E C C = m m n n n n n n	The error code of an error detected by the OS of the CPU module. The display alternates between E C C = m m and n n n n n n approximately every two seconds. The error code is the string of eight alphanumeric characters starting with m m and ending with n n n n n n. For details on the action you need to take, see <i>Chapter 13. Troubleshooting.</i>

10.4.2 Firmware version display

The indicator displays the firmware version.

The version number displayed on the indicator is the control number Hitachi assigns to the firmware.

To display the firmware version:

- (1) With F W V E R displayed on the indicator, press the ◀L/▶R toggle switch towards the ▶R position.
The firmware version appears on the indicator.
- (2) With the firmware version displayed on the indicator, press the ESC switch to return to F W V E R display.

Interpreting the display

The firmware version is displayed as string of six alphanumeric characters.

10.4.3 OS version display

The indicator displays the version of the OS.

To display the OS version:

- (1) With o S V E R displayed on the indicator, press the ◀L/▶R toggle switch towards the ▶R position.
The OS version appears on the indicator.
- (2) With the OS version displayed on the indicator, press the ESC switch to return to o S V E R display.

Interpreting the display

The OS version is displayed in the format $n n - m m$ (where n and m are numerals).

10.4.4 CPU module error status display

The indicator displays the error status of the CPU module. This includes the error status detected by firmware, and the error status detected by the OS.

To display the error status of the CPU module:

- (1) With ERRSTS displayed on the indicator, press the ◀L/▶R toggle switch towards the ▶R position. ECF C 0 appears on the indicator.
- (2) With ECF C 0 displayed on the indicator, press the ▲UP/▼DOWN toggle switch towards the ▲UP or ▼DOWN position to toggle between error locations ECF C 0 and ECC C 0.
- (3) Select an error location, and press the ◀L/▶R toggle switch towards the ▶R position. The error code appears on the indicator.
- (4) Press the ESC switch in any of these display states to return to the previous state.

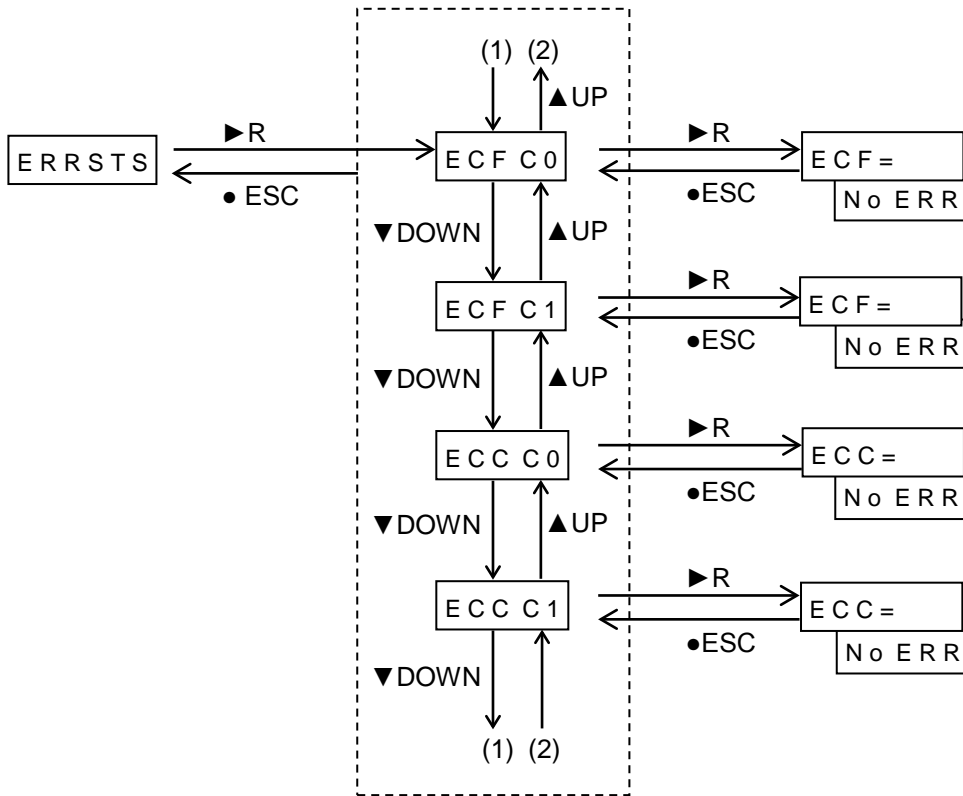

Figure 10-5 Display transitions of CPU module error status

Interpreting the display

● Display of error status detected by firmware

If the firmware has detected an error, the display alternates between `E C F = m m` and `n n n n n n` approximately every two seconds. The error code is the string of eight alphanumeric characters starting with `m` and ending with `n n n n n n`.

For details on specific error codes, see *Chapter 13. Troubleshooting*.

If the firmware has not detected an error, the display alternates between `E C F =` and `N o E R R` approximately every two seconds.

● Display of error status detected by OS

If the OS has detected an error, the display alternates between `E C C = m m` and `n n n n n n` approximately every two seconds. The error code is the string of eight alphanumeric characters starting with `m m` and ending with `n n n n n n`.

For details on specific error codes, see *Chapter 13. Troubleshooting*.

If the OS has not detected an error, the display alternates between `E C C =` and `N o E R R` approximately every two seconds.

Table 10-7 CPU module error status display

No.	Display	Description
1	<code>E R R S T S</code>	The title of the error status menu of the CPU module.
2	<code>E C F C 0</code>	Displays an error detected by processor core 0 while the firmware of the CPU module is running.
3	<code>E C F C 1</code>	Displays an error detected by processor core 1 while the firmware of the CPU module is running.
4	<code>E C C C 0</code>	Displays an error detected by processor core 0 while the CPU module OS (such as Ethernet or PADT interface communication and indicator display control) is running.
5	<code>E C C C 1</code>	Displays an error detected by processor core 1 while the CPU module OS (such as scheduler, ladder, or HI-FLOW) is running.
6	<code>E C F = X X</code> <code>X X X X X X</code>	The error detected by the firmware of the CPU module. For details on the action you need to take, see <i>Chapter 13. Troubleshooting</i> . (<code>X X X X X X X X</code> : Eight-digit error code)
7	<code>E C F =</code> <code>N o E R R</code>	Displayed when the firmware of the CPU module has not detected an error (the state is normal).
8	<code>E C C = X X</code> <code>X X X X X X</code>	The error detected by the CPU module OS. For details on the action you need to take, see <i>Chapter 13. Troubleshooting</i> . (<code>X X X X X X X X</code> : Eight-digit error code)
9	<code>E C C =</code> <code>N o E R R</code>	Displayed when the CPU module OS has not detected an error (the state is normal).

10.4.5 Indicator pattern display (available when CPU module is in STOP mode)

You can use this mode to make sure that the indicator is displaying characters and symbols correctly.

To check the indicator pattern display:

- (1) If you press the SET switch while L E D C H K is displayed, " *+" appears on the indicator.
- (2) With *+ displayed on the indicator, press the ▲UP/▼DOWN toggle switch towards the ▲UP or ▼DOWN position to display No. 2 to No. 11 in Table 10-8 in turn.
- (3) Press the ESC switch while any of No. 2 to No. 11 in Table 10-8 is displayed to return to the L E D C H K display.

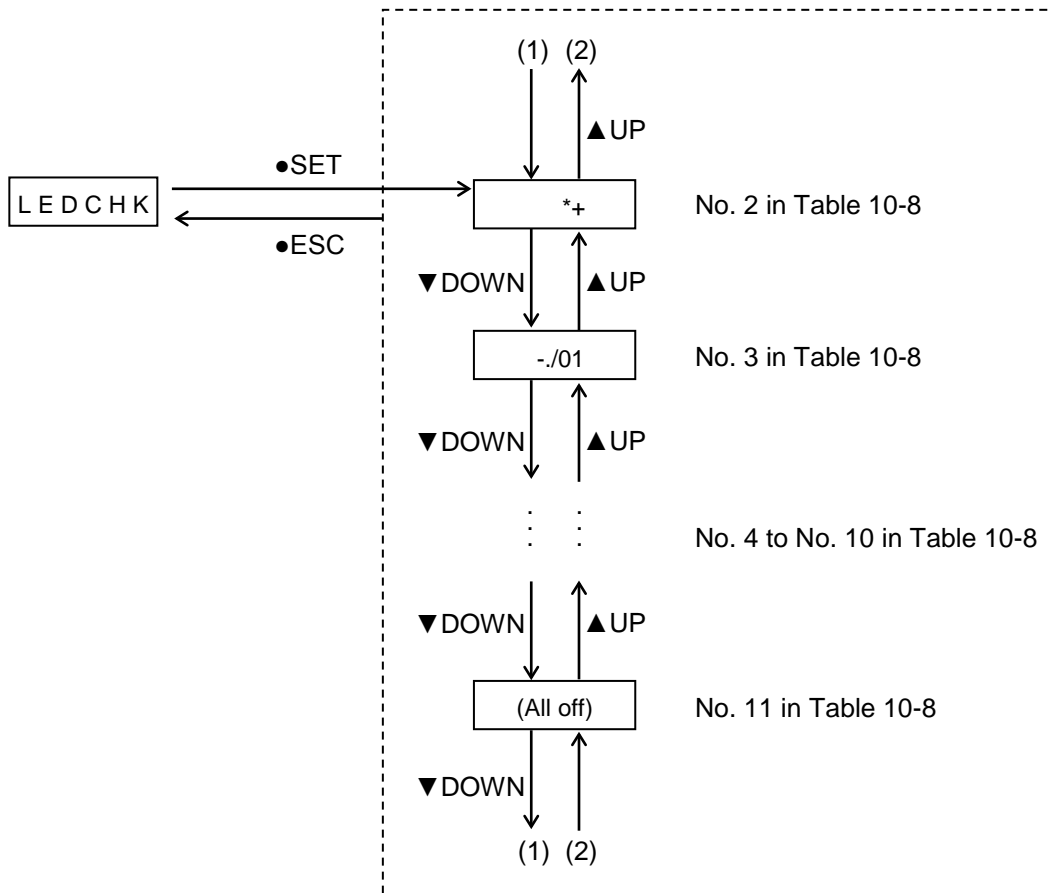

Figure 10-6 Display transitions of indicator patterns

Table 10-8 Indicator patterns

No.	Display	Description
1	L E D C H K	The title of the menu for checking indicator pattern display. This item appears when the CPU module is in STOP mode.
2	*+	Display pattern 1
3	-. / 01	Display pattern 2
4	2 3 4 5 6 7	Display pattern 3
5	8 9 : ; < =	Display pattern 4
6	> ? @ A B C	Display pattern 5
7	D E F G H I	Display pattern 6
8	J K L M N o	Display pattern 7
9	P Q R S T U	Display pattern 8
10	V W X Y Z	Display pattern 9
11	(All off)	Display pattern 10

10.4.6 Ladder mode display (extended menu)

You can use this mode to check whether ladder logic is in normal mode or simulation mode.

To check the ladder mode:

- (1) With L D N / S displayed on the indicator, press the ◀L/▶R toggle switch towards the ▶R position to display the ladder mode (No. 2 or No. 3 in Table 10-9).
- (2) Press the ESC switch while No. 2 or No. 3 in Table 10-9 is displayed to return to the L D N / S display.

Table 10-9 Ladder mode display

No.	Display	Description
1	L D N / S	The title of the ladder mode display menu.
2	L D N o R	Indicates that ladder logic is in normal mode.
3	L D S I M	Indicates that ladder logic is in simulation mode.

10.4.7 PCs number display (extended menu)

The indicator displays the PCs number assigned to the CPU module.

To display the PCs number:

- (1) With P C S N o displayed on the indicator, press the ◀L/▶R toggle switch towards the ▶R position to display the PCs number (for example P N 0 0 0 0). For details on how to assign a PCs number, see *Chapter 8. Tools.*
- (2) Press the ESC switch while the PCs number is displayed to return to the P C S N o display.

10.4.8 Display of E coils in ON mode (extended menu)

The indicator displays the numbers of the E coils that are in ON mode.

To display the E coil numbers:

- (1) With E C o I L displayed on the indicator, press the ◀L/▶R toggle switch towards the ▶R position. The indicator displays an E coil that is in ON mode. The relevant area is from E0000 to E01FF. If multiple E coils are ON, press the ▲UP/▼DOWN toggle switch towards the ▲UP or ▼DOWN position to display the next or previous E coil number. If all areas subject to E coil display are OFF, A L L o F F appears on the indicator.
- (2) Press the ESC switch while an ON E coil number or A L L o F F is displayed to return to the E C o I L display.

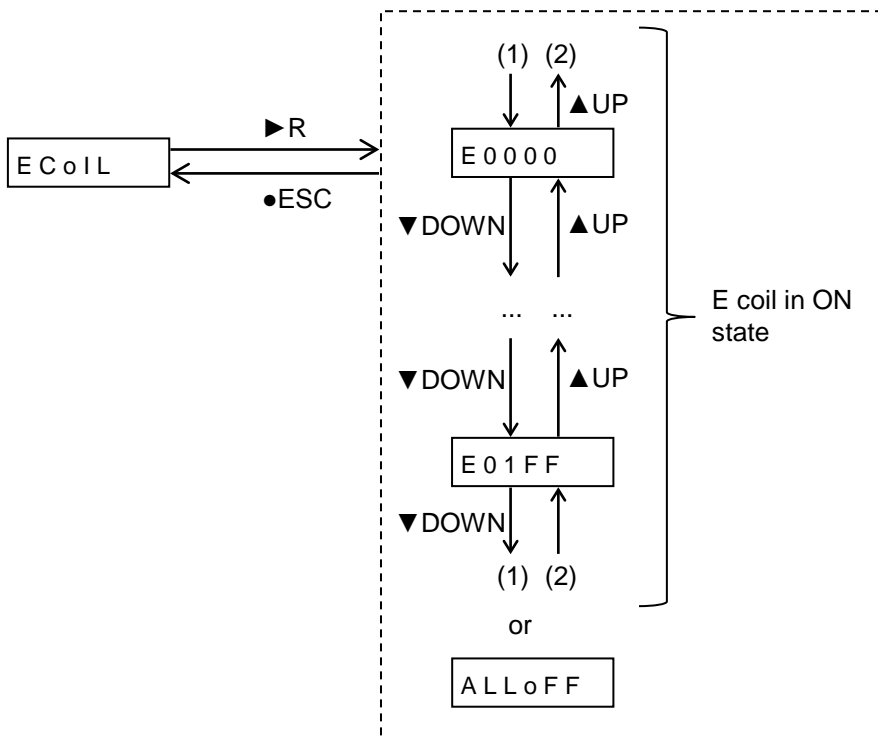

Figure 10-7 Display transitions of E coils in ON states

11. Operation

11.1 Starting and stopping the CPU module

The running of user programs and remote I/O communications are performed according to the settings of the S10VE CPU module.

- (1) Operating status of user programs and remote I/O communications according to the settings of the CPU module
Table 11-1 shows the status of user programs and remote I/O communications according to the settings of the S10VE CPU module.

Table 11-1 User programs and remote I/O communications according to the settings of the CPU module

No.	Power switch on the power module	CPU module settings			User program			Remote I/O communication
		CPU RUN/STOP switch	LADDER RUN/STOP switch	LADDER operation mode setting#	C language	Ladder	HI-FLOW	
1	OFF	--	--	--	Stop	Stop	Stop	Stop
2	ON	STOP	STOP	--	Stop	Stop	Stop	Stop
3	ON	STOP	RUN	--	Stop	Stop	Stop	Stop
4	ON	RUN	STOP	--	Operation	Stop	Stop	Stop
5	ON	RUN	RUN	NORM	Operation	Operation	Operation	Operation
6	ON	RUN	RUN	SIMU	Operation	Operation	Operation	Stop

#: Specify the settings in the software according to BASE SYSTEM/S10VE.

- To start the CPU module by using a reset, change the CPU RUN/STOP switch from the STOP to the RUN position.
- To stop the CPU module when the RUN LED is on, change the CPU RUN/STOP switch from the RUN to the STOP position.

Note: If you want an initial start when the RUN LED is on, change the CPU RUN/STOP switch from the RUN to the STOP position, and then to the RUN position again. If the software has issued a remote STOP request, you cannot change the CPU RUN/STOP switch to the RUN position. Use the software to issue a remote RUN request.

- (2) Starting and stopping via remote control

You can start and stop the system over the network by using a PC. For details on the specific procedure, see the software manual for the application you are using.

- S10VE Software Manual Programming Ladder Diagram System for Windows® (manual number SEE-3-121)
- S10VE Software Manual Programming HI-FLOW for Windows® (manual number SEE-3-122)
- S10VE Software Manual Operation Ladder Diagram System for Windows® (manual number SEE-3-131)
- S10VE Software Manual Operation HI-FLOW for Windows® (manual number SEE-3-132)
- S10VE Software Manual CPMS General Description and Macro Specifications (manual number SEE-3-201)

11.2 User program operations

The following describes the operation of user programs (ladder, HI-FLOW, and C language).

For ladder programs and HI-FLOW, user programs operate on a sequence cycle specified by the user. C-language programs (user tasks) operate asynchronously with ladder programs and HI-FLOW.

In addition, if you are using both ladder programs and HI-FLOW, HI-FLOW processing occurs after ladder program processing.

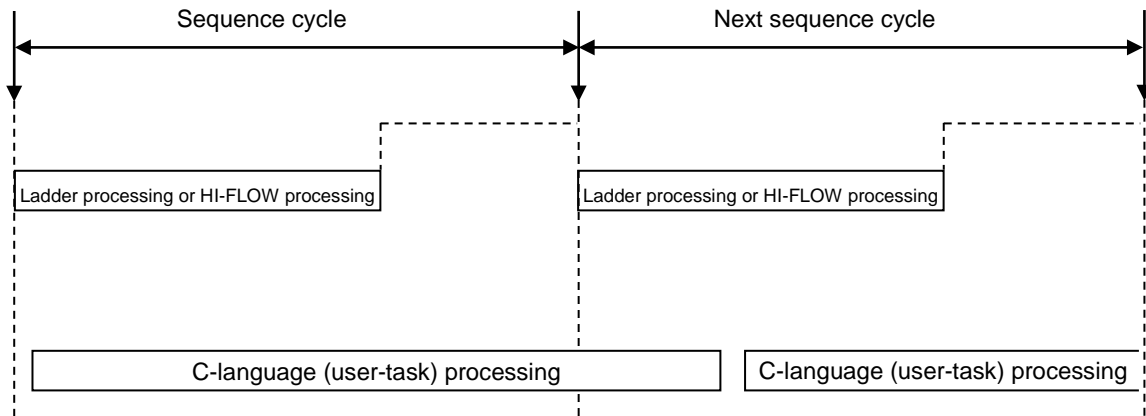

Figure 11-1 User program operation (ladder and HI-FLOW individual use)

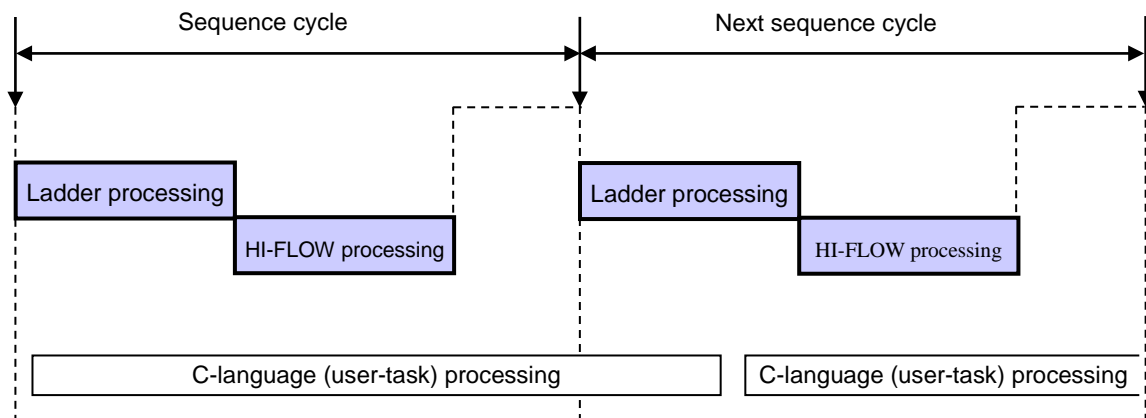

Figure 11-2 User program operation (ladder and HI-FLOW simultaneous use)

If the sequence cycle is set to a time that is longer than the program processing time, program processing is performed with the sequence cycle. After programs are finished, the system stands by until the next start time.

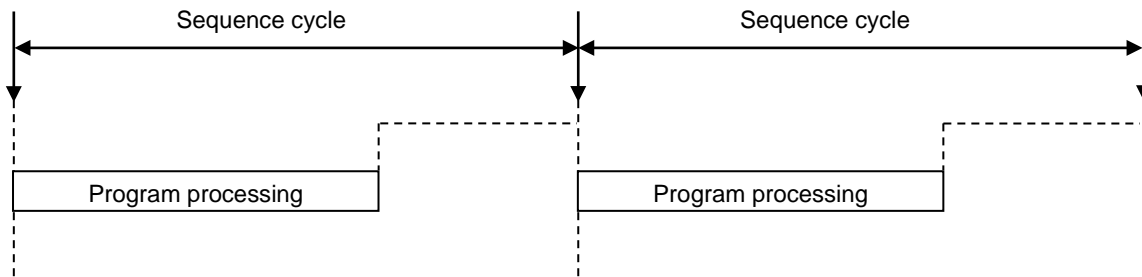

Figure 11-3 Operation when the sequence cycle is longer than the program processing time

If the sequence cycle is set to a time that is shorter than the program processing time, program processing immediately returns to the start of the program again after the program terminates, and processing repeats.

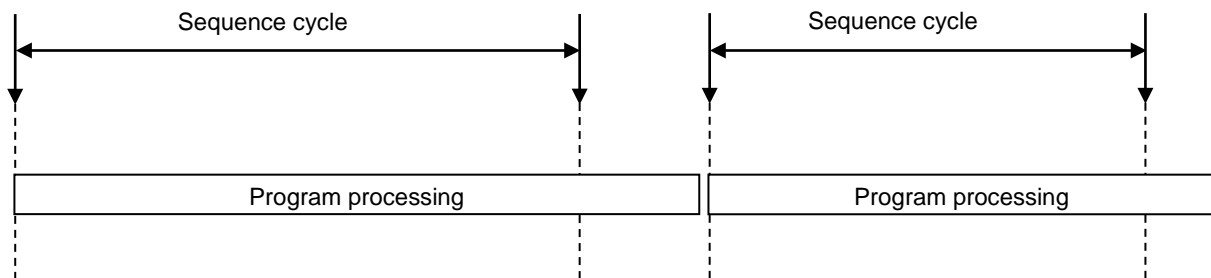

Figure 11-4 Operation when the sequence cycle is shorter than the program processing time

For detailed information about specific applications, see the software manual for the application you are using.

- S10VE Software Manual Programming Ladder Diagram System for Windows® (manual number SEE-3-121)
- S10VE Software Manual Programming HI-FLOW for Windows® (manual number SEE-3-122)
- S10VE Software Manual Operation Ladder Diagram System for Windows® (manual number SEE-3-131)
- S10VE Software Manual Operation HI-FLOW for Windows® (manual number SEE-3-132)
- S10VE Software Manual CPMS General Description and Macro Specifications (manual number SEE-3-201)

11.3 Remote I/O operation

The following describes the remote I/O communication operation of the RI/O-IF module (model: LQE950).
 If you are running a CPU unit with a PI/O module installed, the PI/O module of the CPU unit operates in the same manner as the PI/O module of the PI/O unit.

11.3.1 Remote I/O connection configuration

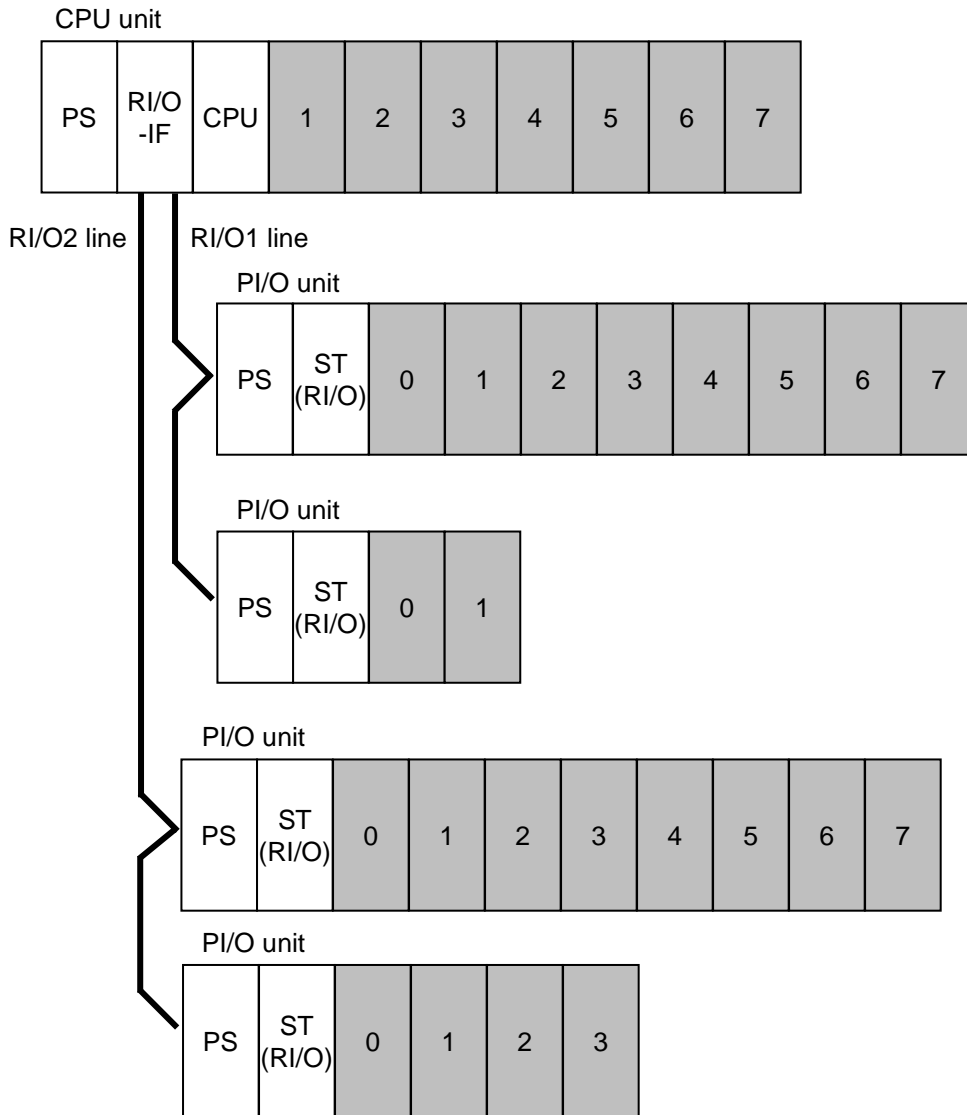

Figure 11-5 Remote I/O connection configuration

11.3.2 Synchronous and asynchronous ladder operation

You can specify settings for synchronous or asynchronous ladder processing with remote I/O transfer input and output. Figure 11-6 describes synchronous and asynchronous ladder operation.

When ladder processing is asynchronous, ladder processing and remote I/O transfer operations are performed individually. For this reason, you can have remote I/O transfers operate in a shorter time. However, because the PI/O memory changes during ladder processing in one sequence cycle, actual ladder processing and operation might differ from what is expected.

During synchronous ladder operation, the next remote I/O transfer operation is not performed until the ladder processing during one sequence cycle is complete. For this reason, the PI/O memory does not change during one sequence cycle, and ladder processing is performed as expected. However, remote I/O transfer periods become longer as ladder programs grow larger.

■ Operation in asynchronous mode

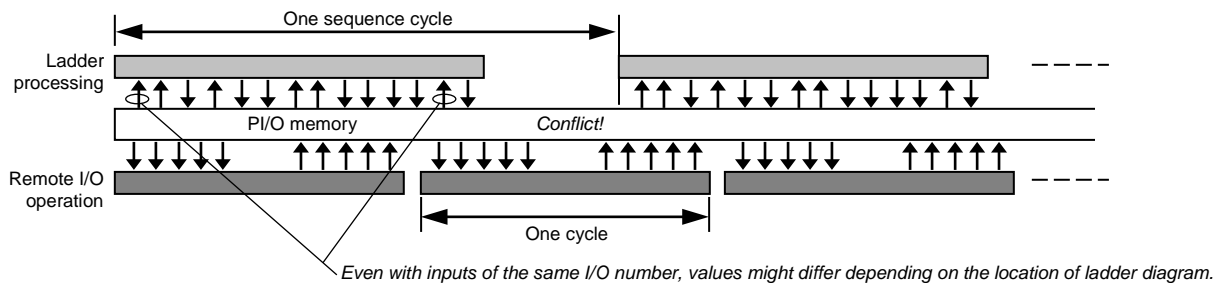

■ Operation in synchronous mode

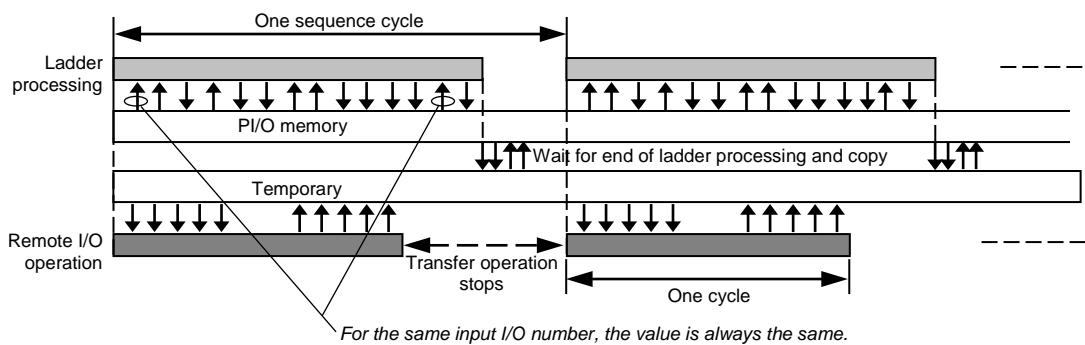

Note: In synchronous mode, the time for one sequence cycle cannot be made shorter than the time for one cycle of the remote I/O.

Figure 11-6 Synchronous and asynchronous ladder operation

11.3.3 Processing time

Figure 11-7 shows a representation of the processing time until an external output signal is output from the output module, after an external input signal is input into the input module. If the external input signal, the remote I/O line transfer operation, and the ladder processing are performed asynchronously, the sum total of (1) through (4) is not always accurate, but this value can serve as a rough estimate. If remote I/O is operating according to the ladder synchronous mode, (3) is always the time for one sequence cycle.

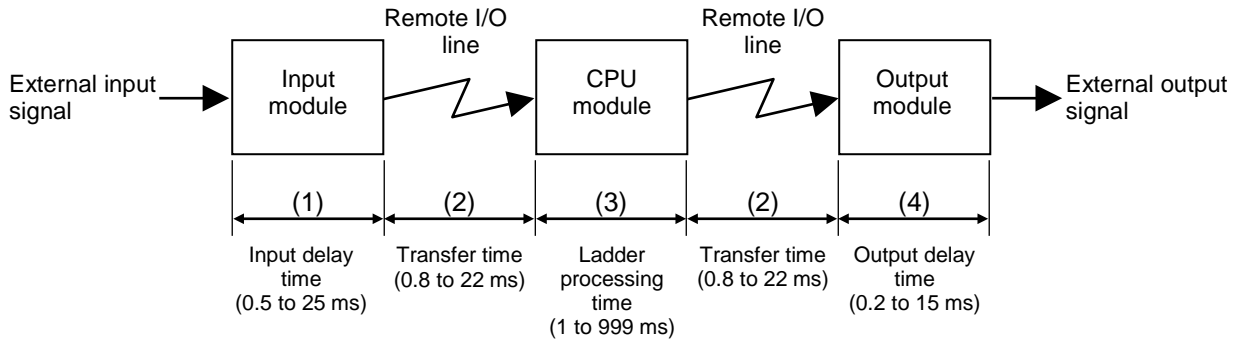

Figure 11-7 Processing time concept

(1) Input delay time

This is the response time of the input module. The response time differs depending on the type of input module, but for transistor-based modules the time is about 0.5 ms, while relay-based modules have times ranging from about 10 to 25 ms. For details, see *S10mini Hardware Manual I/O Modules* (manual number SME-1-114) or *HSC-2100 Hardware Manual I/O Modules* (manual number SME-1-126).

(2) Remote I/O transfer time

This is the time required to transfer data on the remote I/O line. Transfer time varies depending on the I/O point settings and whether a timeout has occurred on the line. Table 11-2 gives an overview of the transmission time required for one cycle (one scan) based on the I/O points, but if a timeout has occurred on the line, check and correct the remote I/O point settings.

Table 11-2 Overview of the transmission time required for one cycle (one scan)

No.	Remote I/O points	Overview of the transmission time required for one cycle (one scan)	Notes
1	64	0.8 ms	No timeout has occurred on the line
2	128	1.5 ms	
3	256	2.8 ms	
4	512	5.5 ms	
5	1024	11 ms	
6	1536	16.5 ms	
7	2048	22 ms	
8	Timeout on the line (about 16 points)	+0.085 ms (+85 μs)	This is the rough amount of time added to the communication time when a timeout occurs once on the line in about 16 points.

Note: When using ladder synchronization mode, the communication time is the same as that shown above, but the time for one sequence (one scan) depends on the ladder running time.

For an input transfer, the external input signal and the remote I/O transfer operation are not synchronized. For this reason, the input value of the input module is sometimes determined immediately after the transfer starts. In such a case, the correct input value is not transmitted to the CPU module until the next transfer cycle, which results in a required transfer time of about twice as much (1.6 to 44 ms). For an output transfer where the remote I/O is operating asynchronously with the ladder, the ladder processing results are sometimes determined immediately after the transfer starts. In this case as well, the correct processing results are not transmitted to the output module until the next transfer cycle, which results in a required transfer time of about twice as much (1.6 to 44 ms). If remote I/O is operating synchronously with ladder processing, the transfer time always ends within the time of one cycle (0.8 to 22 ms).

(3) Ladder processing time

This is the time required to process ladder programs. After a cycle starts, this time becomes the value specified as the sequence cycle time (from 1 to 999 ms). However, if the ladder program processing takes longer than the sequence cycle time, the time becomes the processing time for the ladder program. For an input transfer where the remote I/O is operating asynchronously with the ladder, the input value from the remote I/O is sometimes transmitted to the CPU module immediately after one sequence cycle for the ladder program starts. In this case, the correct processing results cannot be obtained until the next sequence cycle, which results in a required ladder processing time of about twice as much. If remote I/O is operating synchronously with ladder processing, the time for one sequence cycle is always the same as the ladder processing time.

(4) Output delay time

This is the response time of the output module. The response time differs depending on the type of output module, but for transistor-based modules the time is about 0.2 ms, while relay-based modules have times ranging from about 10 to 15 ms. For details, see *S10mini Hardware Manual I/O Modules* (manual number SME-1-114) or *HSC-2100 Hardware Manual I/O Modules* (manual number SME-1-126).

Accurate calculations of a value for the processing time are not possible, but you can calculate an approximate processing time and maximum processing time as follows:

<p>Approximate processing time = (1) + (2) + (3) + (2) + (4) = (input delay time) + (remote I/O input transfer time) + (ladder processing time) + (remote I/O output transfer time) + (output delay time)</p> <p>Maximum processing time (remote I/O ladder asynchronous) = (1) + (2) × 2 + (3) × 2 + (2) × 2 + (4) = (input delay time) + (remote I/O input transfer time) × 2 + (ladder processing time) × 2 + (remote I/O output transfer time) × 2 + (output delay time)</p> <p>Maximum processing time (remote I/O ladder synchronous) = (1) + (2) × 2 + (3) + (2) + (4) = (input delay time) + (remote I/O input transfer time) × 2 + (ladder processing time) + (remote I/O output transfer time) + (output delay time)</p>
--

11. Operation

11.3.4 Remote I/O transfer points and transfer areas

You can specify one of the following for the remote I/O transfer points: 64, 128, 256, 512, 1024, 1536, and 2048 points. Figure 11-8 shows the remote I/O transfer point settings and transfer areas.

The transfer areas for settings ranging from 64 points to 256 points are shown in the following figure.

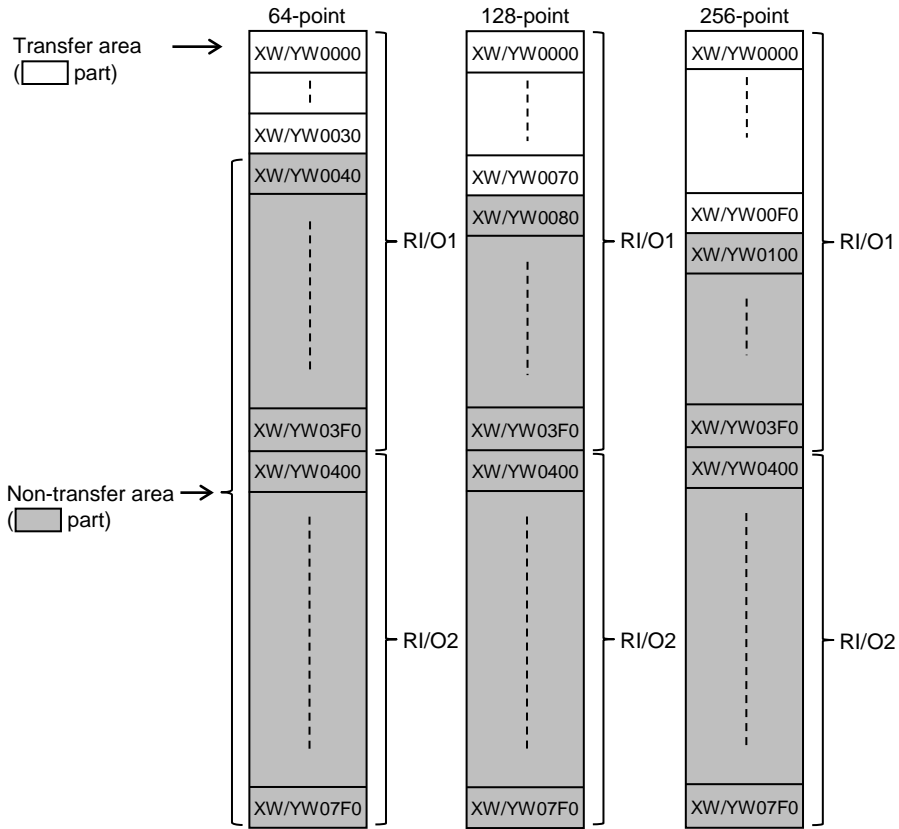

Figure 11-8 Remote I/O transfer point settings (1/2)

The transfer areas for settings ranging from 512 points to 2048 points are shown in the following figure.

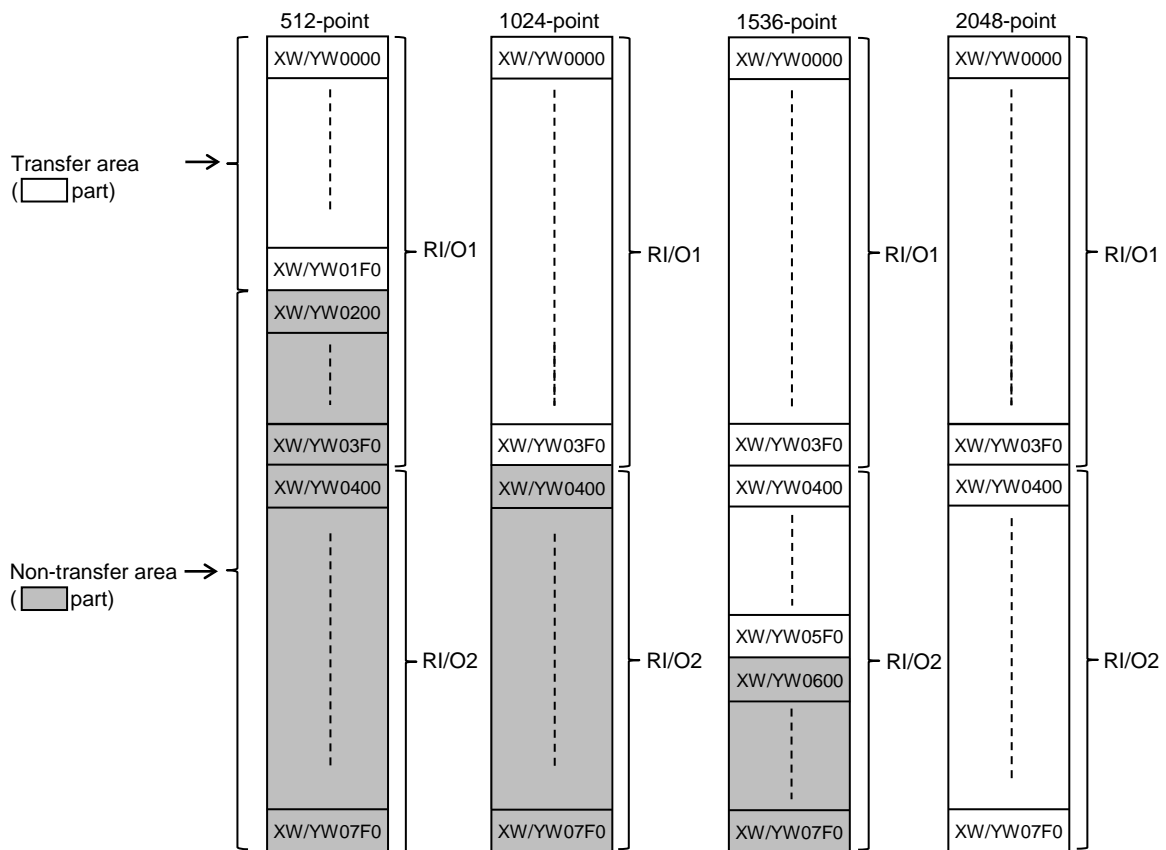

Figure 11-8 Remote I/O transfer point settings (2/2)

11.3.5 Output operations of the digital output module

When an error occurs, such as ladder operations not being possible on the CPU module or disconnection of the remote I/O line of the PI/O unit, the state of the output of the digital output module installed in each unit becomes RESET or HOLD depending on what was set in 9.3.3 *Output hold setting for digital output modules*.

If RESET is set, output is turned off. If HOLD is set, the output from immediately before the error occurred is held.

Note: The output hold setting is valid only for the digital output module.

It is not valid for the analog output module, which always operates with an output hold.

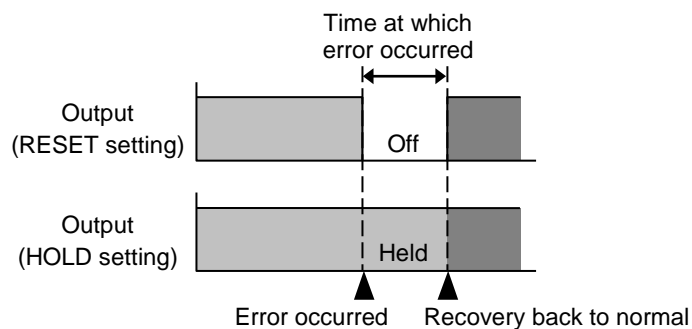

Figure 11-9 Output operation of the digital output module

11.4 List of states and state transitions

11.4.1 List of states

Table 11-3 shows the list of S10VE states.

Table 11-3 S10VE state list

No.	Item	Status	CPMS	User programs		Remote I/O communications
				C language	Ladder HI-FLOW	
1	Power supply off	Power supply off state	Stop	Stop	Stop	Stop
2	Hardware initialization	Hardware initialization state	Stop	Stop	Stop	Stop
3	CPU STOP	CPU STOP state	Stop	Stop	Stop	Stop
4	Minor failure error	- Minor failure under which control is able to continue - Failure under which usage is possible if maintenance is performed (primary battery error or optional module error)	Operation	Operation	Operation	Stop
5	Major failure error (CPU stop)	- Failure under which operation cannot continue - Failure under which incorrect controls are possible if operation continues	Stop	Stop	Stop	Stop
6	OS initialization	CPMS initialization state	Operation	Stop	Stop	Stop
7	LADDER STOP	Ladder, HI-FLOW stop state	Operation	Operation	Stop	Stop
8	Major failure error (CPMS operation in progress)	- Failure under which operation cannot continue - Failure under which incorrect controls are possible if operation continues	Stop	Operation	Stop	Stop
9	System task error (CPMS operation in progress)	- System task error state - Software watchdog timer timeout error state	Operation	Operation	Stop	Stop
10	LADDER RUN	Ladder, HI-FLOW operation state	Operation	Operation	Operation	Operation
11	SIMU RUN	Ladder program simulation state	Operation	Operation	Operation	Stop

11.4.2 State transitions

Figure 11-10 contains the transition conditions of the various states described in Table 11-3, as well as the combinations of the RUN LED, STBY LED, ERR LED, and ALARM LED in the various states.

The ERR LED being on indicates that a hardware or software error (such as a system watchdog timer timeout) has occurred.

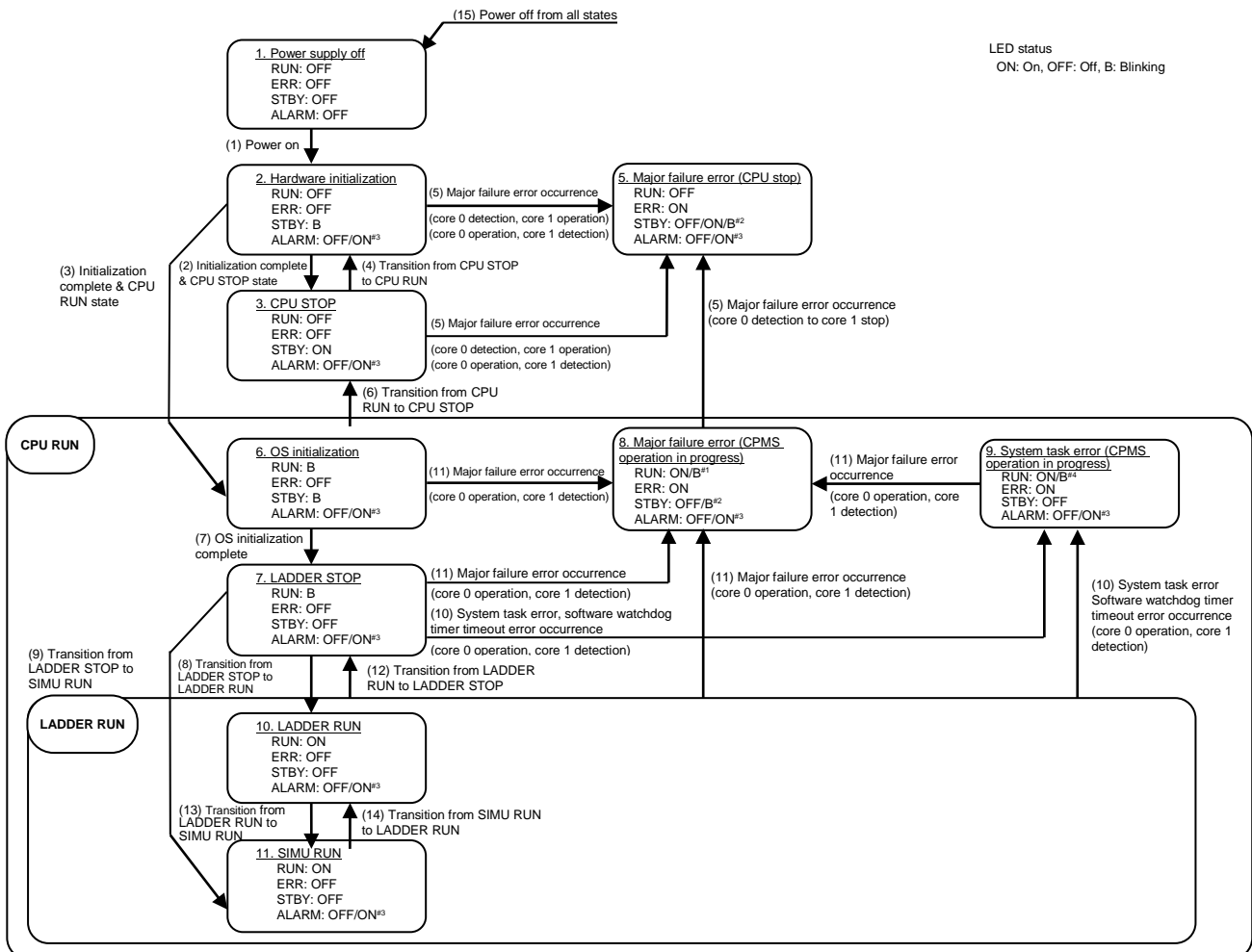

- #1: If a major failure error is detected while the OS is running, the status of the RUN LED is held as the LED status from before the error was detected.
- #2: If a major failure error is detected in the firmware, the STB LED turns off.
If a major failure error is detected while the OS is running, the status of the STB LED is held as the LED status from before the error was detected.
- #3: When a minor failure occurs, the ALARM LED turns on and operation continues.
- #4: If a system task error or software watchdog timer timeout error is detected, the status of the RUN LED is held as the LED status from before the error was detected.

Figure 11-10 S10VE state transitions

11.5 Backup functionality

S10VE has backup functionality, which retains data even when power is lost. The following data is backed up.

- Data that is backed up:
 - CPMS (OS)
 - Application programs
 - PI/O data
 - User release data
 - Time information
 - Error log information from when failures occurred

11.6 Clock functionality

This section describes the clock functionality and how to specify the relevant settings. You can set the clock by using tools and ladder programs.

The following describes how to set the clock by using ladder programs. For details about setting the clock by using tools, see *Chapter 8. Tools*.

11.6.1 System register for clock control

This is a register used for real-time control with ladder programs. It consists of a time register and a time control register.

(1) Time register

This register stores time information consisting of the year, month, day, hour, minute, and second. Set the time in this area when you want to adjust the time. The data is in binary (hexadecimal) format.

(MSB)	2^{15}	2^8 2^7	2^0 (LSB)
SW0280	Reserved		Second
SW0290	Reserved		Minute
SW02A0	Reserved		Hour
SW02B0	Reserved		Day
SW02C0	Reserved		Month
SW02D0	Year (Western calendar)		
SW02E0	Reserved		Day of the week

Notes on setting the clock

- Enter a numerical value for the day of the week.
1: Sunday, 2: Monday, 3: Tuesday, 4: Wednesday, 5: Thursday, 6: Friday, 7: Saturday
- If a non-existent time is entered (such as 0 or 13 for the month, 0 or 35 for the day, 25 for the hour, 60 for the minute, or 60 for the second), the value is ignored and not reflected.
- Enter the hour in 24-hour format.

11. Operation

(2) Time control register

This register controls the settings of the current time. The following describes the register configuration.

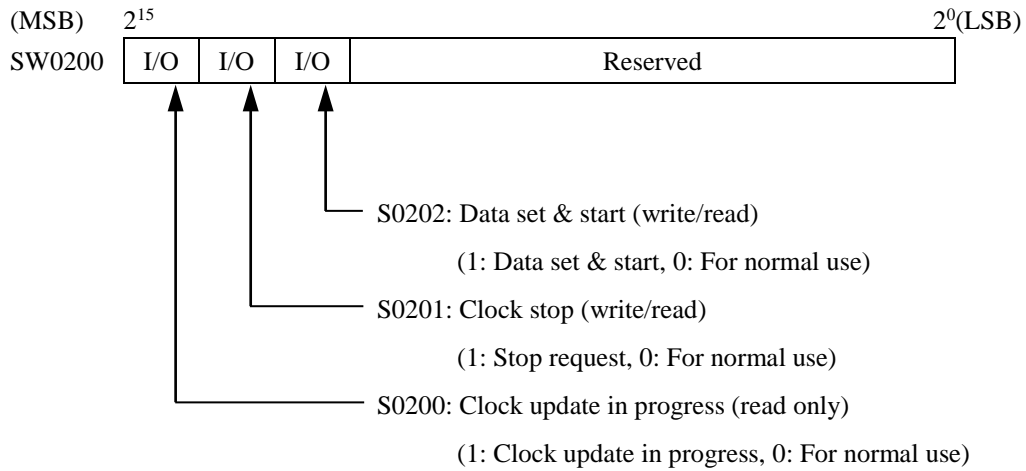

Setting the clock

Use the following procedure to specify the current time.

- [1] Specify "1" for S0201 in the clock control register to stop the clock.
- [2] Specify time data (second, minute, hour, day, month, year, and day of the week) in time storage registers SW0280 through SW02E0.
- [3] Specify "1" for S0202 in the time control register to start the clock from the time that you specified.
- [4] Change the value of S0201 and S0202 in the clock control register back to "0" to return the clock to its usual state.

11.6.2 Setting the clock by using ladder programs

The following shows a ladder program that takes the time data set in the F registers (FW100 through FW106) and specifies it in the clock control registers (SW0280 through SW02E0) when X0000 is "1" (ON). Note that Figure 11-11 explains only the items required to create the ladder program.

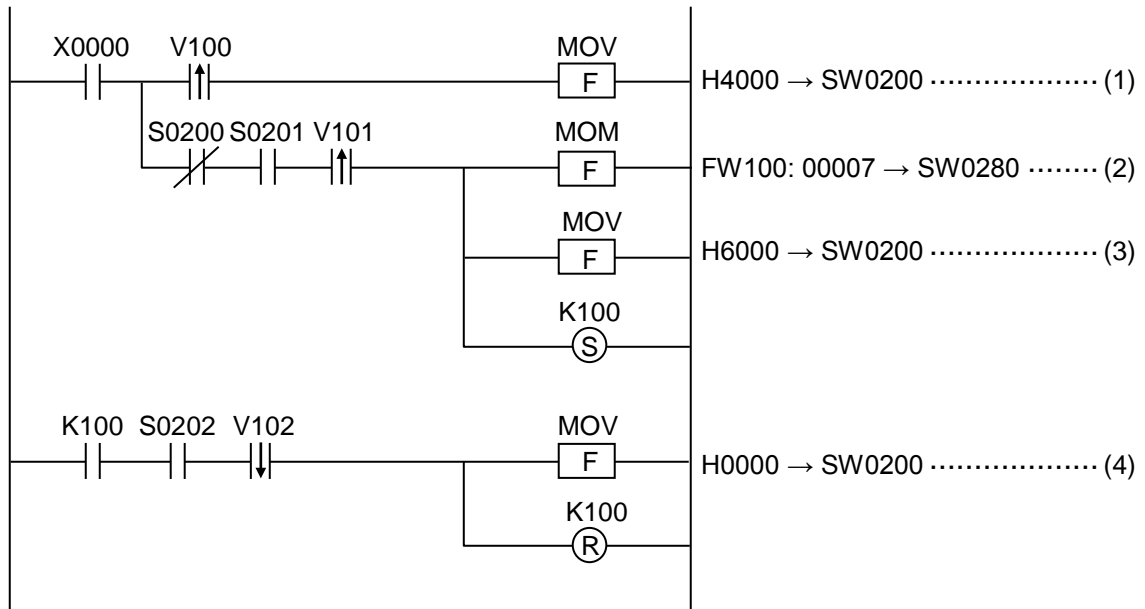
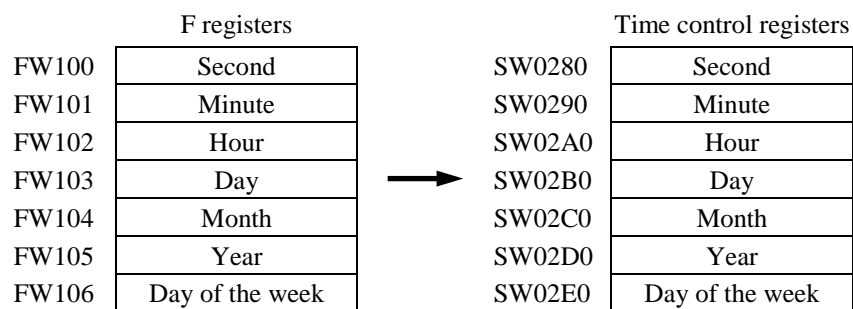

Figure 11-11 Example ladder program for setting the clock

Operation overview

- [1] When X0000 is ON, S0201 is set to "1", and a request to stop the clock is issued.
- [2] The program verifies that the clock has stopped, and takes the time data (second, minute, hour, day, month, year, and day of the week) that was previously specified in the F registers (FW100 through FW106) and specifies it in the time registers (SW0280 through SW02E0).



- [3] S0202 is set to "1", and a data set and start request is issued.
- [4] The program verifies that the data set is complete, S0201 and S0202 return to "0", and the clock settings are complete.

11. Operation

11.6.3 Updating the date

The date is updated automatically as follows:

Automatic determination of long and short months:

31 days for Jan., Mar., May, Jul., Aug., Oct., and Dec. → 1st of the next month

30 days for Apr., Jun., Sept., and Nov. → 1st of the next month

Automatic determination of leap years:

Feb. 29 in a leap year (2020, 2024, 2028) → March 1

Feb. 28 in a non-leap year (2018, 2019, 2021) → March 1

11.7 State signal timing

11.7.1 PCsOK signal

The PCsOK signal is a signal that turns on the contact output when a ladder program is set to RUN.

ON output is enabled when the RUN/STOP switch of the CPU module and the LADDER RUN/STOP switch are set to RUN.

Figures 11-12 and 11-13 show the output timing.

■ Going from STOP to RUN

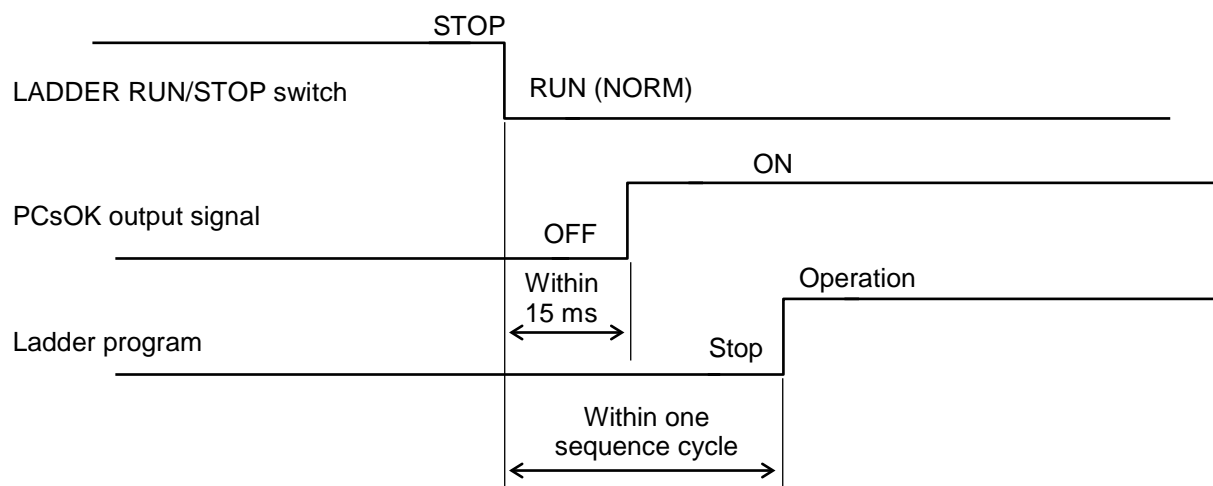

Figure 11-12 Output timing of the PCsOK signal (from STOP to RUN)

Note: If LADDER MODE is set to "SIMU", the PCsOK signal will not turn ON even when the LADDER RUN/STOP switch changes from STOP to RUN (SIMU).

■ Going from RUN to STOP

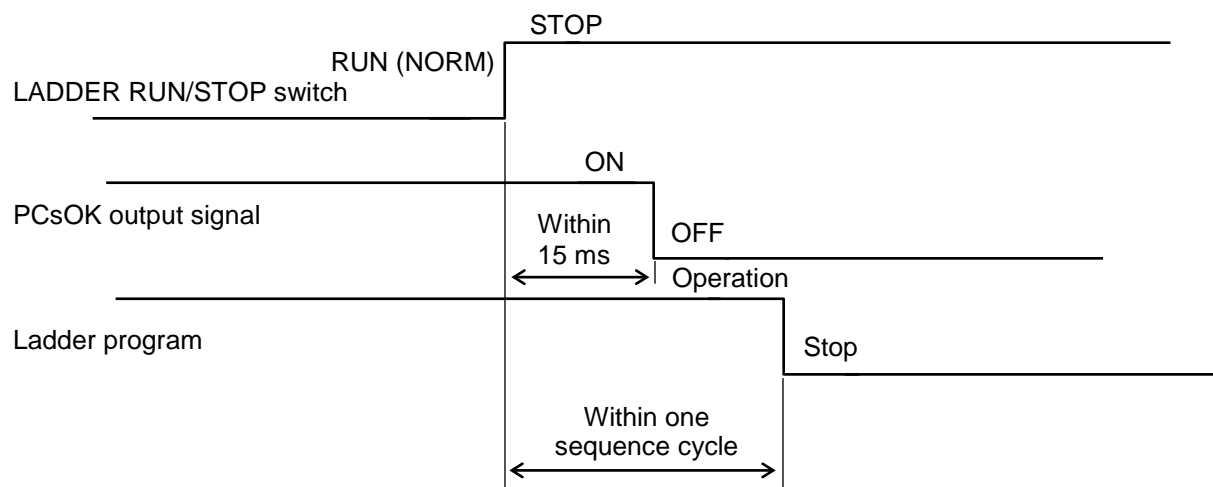

Figure 11-13 Output timing of the PCsOK signal (from RUN to STOP)

11. Operation

11.7.2 Ladder program RUN/STOP signal

The RUN/STOP signal is a signal that controls the RUN and STOP status of a ladder program externally.

When the RUN/STOP switch of the CPU module is set to RUN and the LADDER RUN/STOP switch is set to RUN, you can control the operation or stoppage of a ladder program by using the ON/OFF contact of the RUN/STOP input terminal on the RI/O-IF module.

Figures 11-14 and 11-15 show the operation timing for ladder programs.

- Changing the contact of the RUN/STOP terminal from OFF to ON

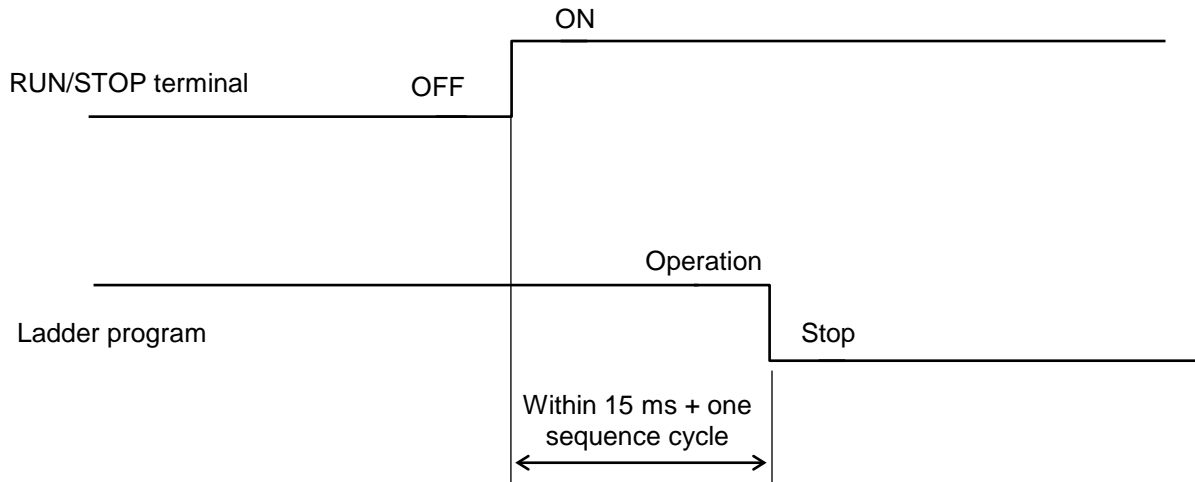

Figure 11-14 Timing of the STOP/RUN input signal (from OFF to ON)

- Changing the contact of the RUN/STOP terminal from ON to OFF

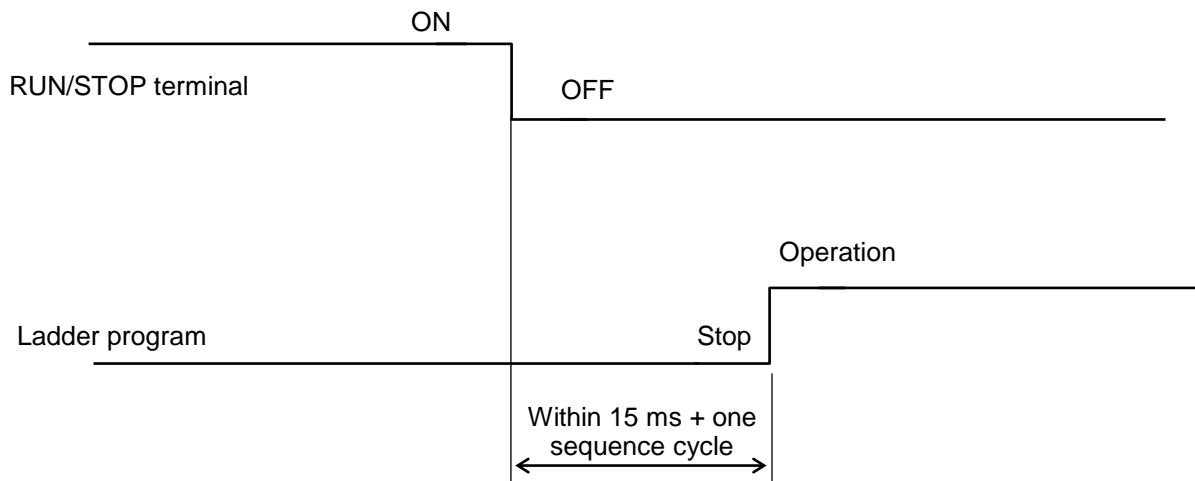

Figure 11-15 Timing of the STOP/RUN input signal (from ON to OFF)

11.7.3 RI/O STOP input signal

The RI/O STOP input signal is a signal used to externally control the stopping of remote I/O communications. When the RUN/STOP switch of the CPU module is set to RUN and the LADDER RUN/STOP switch is set to RUN, you can control the operation or stoppage of a remote I/O transfer by using the ON/OFF contact of the RI/O STOP input terminal on the RI/O-IF module.

Figures 11-16 and 11-17 show the operation timing for remote I/O communications.

- Changing the contact of the RI/O STOP terminal from OFF to ON

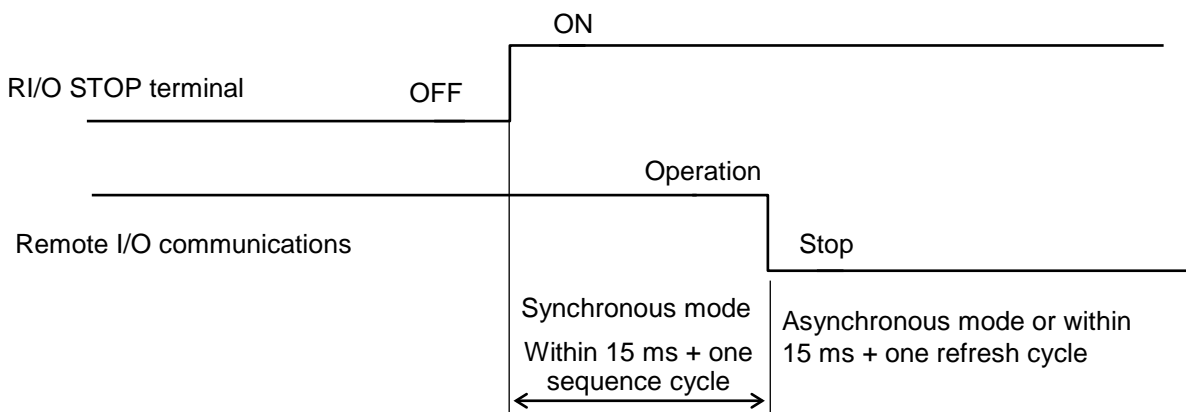

- One sequence cycle is the time specified by using LADDER SYSTEM. Alternatively, it is the time to run a longer ladder program once.
- One refresh cycle is the time for remote I/O communications for the specified points.

Figure 11-16 Timing of the RI/O STOP input signal (from OFF to ON)

Note: When LADDER MODE is set to "SIMU", the remote I/O communications are in a stop state.

- Changing the contact of the RI/O STOP terminal from ON to OFF

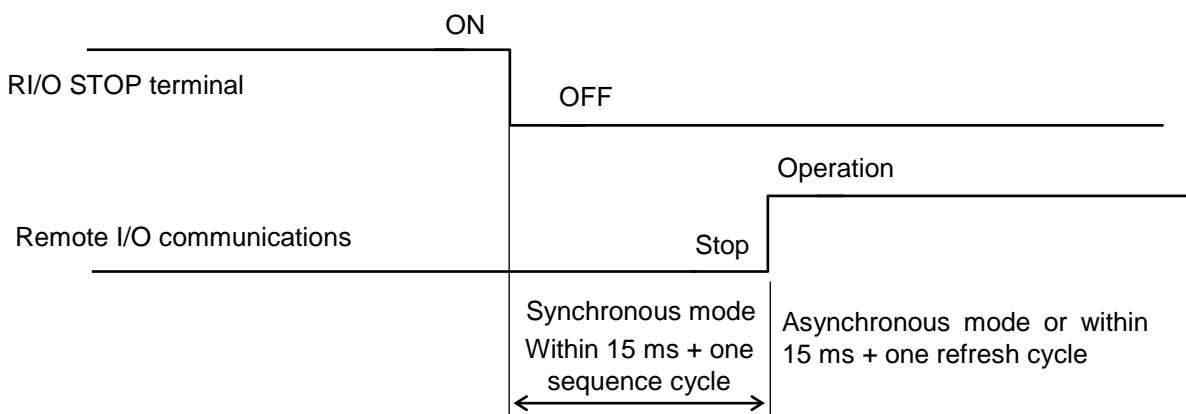

- One sequence cycle is the time specified by using LADDER SYSTEM. Alternatively, it is the time to run a longer ladder program once.
- One refresh cycle is the time for remote I/O communications for the specified points.

Figure 11-17 Timing of the RI/O STOP input signal (from ON to OFF)

Note: When LADDER MODE is set to "SIMU", the remote I/O communications continue in a stop state, even if the RI/O STOP input terminal changes from ON to OFF.

This page is intentionally left blank.

12. Inspection

12.1 Limited-life components and replacement cycle

Table 12-1 lists the limited-life components used in the S10VE, and their replacement cycle.

Table 12-1 Limited-life components and replacement cycle

Limited-life component		Replacement cycle			
Component name	Module	Replacement cycle	Unit of replacement	Model	Manufacturer
Primary battery	CPU	5 years	Primary battery	HDC5200	Hitachi, Ltd.
Aluminum electrolytic capacitor	Power supply	10 years (35°C ambient temperature)	Power supply module	LQV410	Hitachi, Ltd.

Notice

- The aluminum electrolytic capacitors in the power supply module (LQV410) have a limited lifespan. We recommend that you replace the power supply module within 10 years. The service life of the aluminum electrolytic capacitors is approximately 10 years at an ambient temperature of 35°C. The service life halves with every 10°C increase in ambient temperature. When keeping a spare power supply module in long-term storage, store it in an environment with a temperature from 15°C to 40°C and humidity of 65% or less.

12.2 Periodic check items

To keep the S10VE system in optimal condition, we recommend that you conduct routine or periodic inspections. A periodic inspection should occur at least twice a year.

Table 12-2 lists the items to be checked as part of a periodic inspection.

Table 12-2 Check items

No.	Item
(1)	External appearance of modules
(2)	Information presented by indicators and other display devices
(3)	Tightness of mounting screws, terminal block screws, and connector fittings and fixtures
(4)	Condition of cable and wire sheaths
(5)	Presence of dust or dirt
(6)	Fluid leakage from inside the power supply module
(7)	Power supply voltage (of power supply module and miscellaneous external power sources)

(1) External appearance of modules

Inspect the module housings for cracks or splits. A problem with the housing might be a sign of damage to the internal circuitry and a potential cause of system malfunction.

(2) Information presented by indicators and other display devices

Inspect the indicator and other display devices for information about abnormalities in the system.

(3) Tightness of mounting screws, terminal block screws, and connector fittings and fixtures

Turn off the power supply of the system before performing this inspection.

Make sure that no screws have come loose. This includes module fixing screws, terminal block screws, and cable connector fittings.

Tighten any loose screws you find. Loose screws can cause the system to malfunction or result in burn damage due to heating.

(4) Condition of cable and wire sheaths

Inspect the cable and wire sheaths for abnormalities or signs of heat. If a sheath has separated from its cable or become unusually hot, this can cause the system to malfunction, or pose a risk of electric shock or burn injury from a short circuit.

(5) Presence of dust or dirt

Inspect the modules for dust or dirt. Turn off all power supplies, and use a vacuum cleaner to remove dust from the module housings to prevent it from building up on surfaces. Dust buildup can cause a short circuit in the internal circuitry, potentially causing burn damage to the equipment.

- (6) Fluid leakage from inside the power supply module
Inspect the power supply module for fluid leaks.
- (7) Power supply voltage (of power supply module and miscellaneous external power sources)
Make sure that the input and output voltages of the power supply module and the voltages of any external power sources are within rated values. Voltages outside the product rating can cause the system to malfunction. You can determine the output voltage of the power supply module by checking the voltage at the output voltage check terminal. For details about the applicable rating values and the output voltage check terminal, see *Chapter 5. Part Names and Functions*.

**CAUTION**

- Make sure that the screws are securely tightened. Failing to do so can cause smoke, fire, or malfunction, or cause the module to fall.

Notice

- Static electricity might damage a module or cause it to malfunction. Discharge any static electricity from your body before touching the equipment.

This page is intentionally left blank.

13. Troubleshooting

When a failure occurs, follow the procedure in Figure 13-1 to troubleshoot the problem.

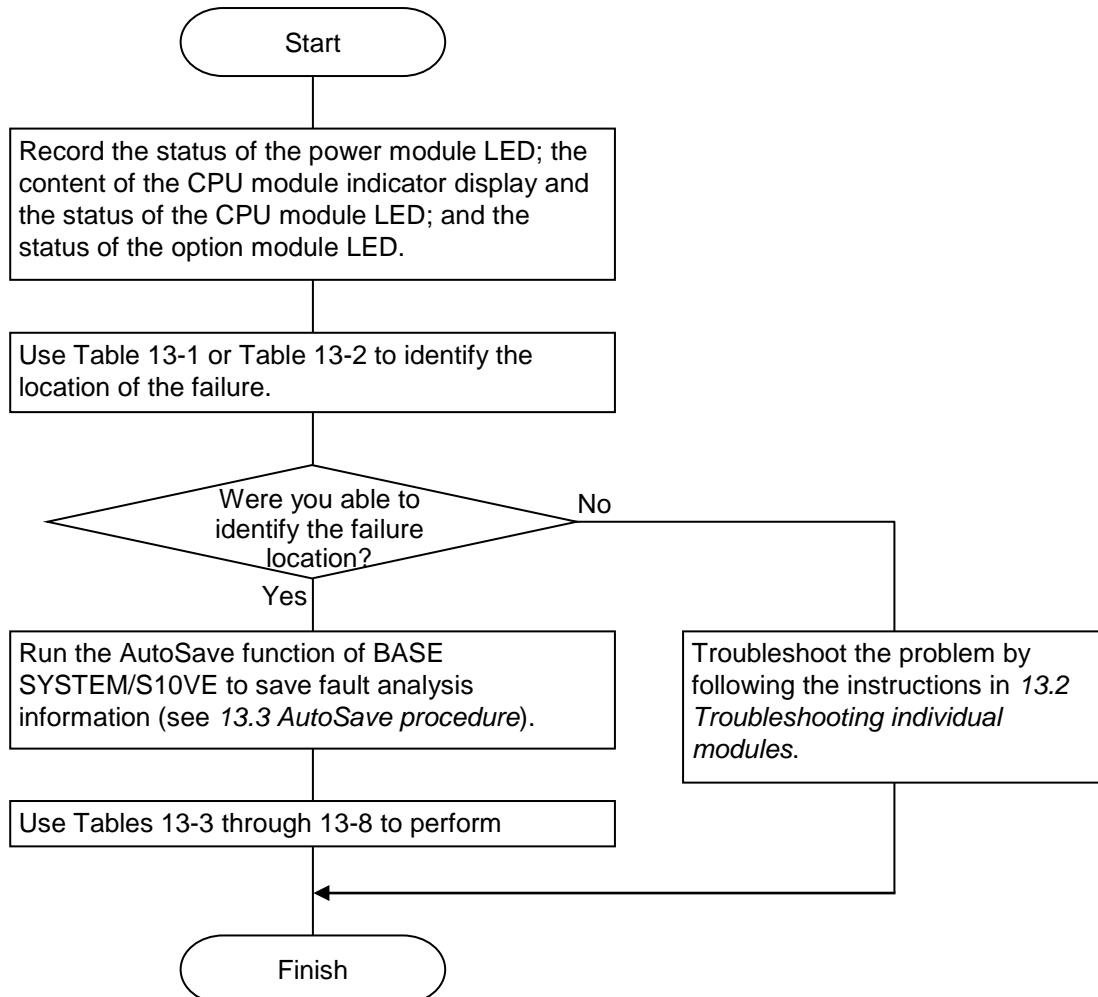

Figure 13-1 Troubleshooting procedure

13.1 Troubleshooting via visual confirmation of LEDs and indicators

13.1.1 Power supply module (model: LQV410)

Table 13-1 describes using visual confirmation of the power supply module LEDs to diagnose problems.

Table 13-1 Diagnosing problems by visually confirming the power supply module LEDs

Legend: ON: On, OFF: Off

No.	Check item			Corrective action
	POWER LED	OC LED	OV LED	
1	OFF	OFF	OFF	Verify that the correct power supply voltage is being applied. If the correct power supply voltage is applied, the power supply module has failed. Replace the power supply module.
2	OFF	ON	OFF	The total current consumption value of the modules installed in the CPU unit exceeds the rating of the power supply module (10 A). Check and correct the number of modules installed in the CPU unit. If the OC LED stays on after reviewing, the power supply module has failed. Replace the power supply module.
3	OFF	OFF	ON	The power supply module is damaged. Replace the power supply module.
4	ON	OFF	OFF	The system is operating normally.

13.1.2 CPU module (model: LQP600)

Table 13-2 describes using visual confirmation of the indicators and LEDs of the CPU module to diagnose problems.

Table 13-2 Diagnosing problems by visually confirming the CPU module LEDs

Legend: ON: On, OFF: Off, B: Blinking, --: Ignore

No.	Check item				Indicator display	Corrective action
	LED					
	RUN	STBY	ALARM	ERR		
1	--	--	--	ON	Alternating display of "ECF=xx" and "xxxxxx"	Reset the CPU module. If the problem persists even after the reset, replace the CPU module.
2	--	--	--	ON	Alternating display of "ECC=xx" and "xxxxxx"	Use Table 13-3 to identify the error, and then take corrective action.
3	--	--	ON	OFF	AL9002	The voltage of the primary battery has fallen. Replace the primary battery by referring to <i>14.2.2 Replacing the primary battery</i> .
4					01xxxx	An error has occurred in the OD.RING module. Use Table 13-4 to eliminate the cause of the error.
5					02xxxx	An error has occurred in the FL.NET module. Use Table 13-5 to eliminate the cause of the error.
6	--	--	ON	OFF	03xxxx	An error has occurred in the J.NET module. Use Table 13-6 to eliminate the cause of the error.
7					04xxxx	An error has occurred in the D.NET module. Use Table 13-7 to eliminate the cause of the error.
8					0Exxxx	An error has occurred in the ET.NET module. Use Table 13-8 to eliminate the cause of the error.
9	OFF	ON	OFF	OFF	CPUSTP	The CPU module is stopped. Set CPMS loading or the CPU RUN/STOP switch to RUN.
10	OFF	B	OFF	OFF	LDRSTP	Ladder program execution is stopped. Set the LADDER RUN/STOP switch to the RUN position.
11	--	B	OFF	OFF	H-0000 to H-0070 W-0000 to W-00A0 oSLD:0 to oSLD:8	These are displayed after the power has been turned on and when the system is starting up. If one of the items to the left is displayed continuously for one minute or more, reset the CPU module. If the problem persists even after the reset, replace the CPU module.
12	ON	OFF	OFF	OFF	--	The system is operating normally.

Table 13-3 CPU module troubleshooting (1/2)

#: The indicator display alternates between displaying the first six characters and the last six characters.

Example: "ECC=03030000" is displayed as "ECC=03" and "030000" alternating.

No.	LED status		Indicator display#	Description	Recovery operation
	ERR LED	ALARM LED			
1	On	--	ECC=03030000	Instruction alignment error	Reset the system. If the error occurs repeatedly, replace the hardware.
2	On	--	ECC=03040000	Illegal instruction error	
3	On	--	ECC=030F0000	Illegal exception error	
4	On	--	ECC=03380000	Floating-point unavailable exception	
5	On	--	ECC=03390000	Floating-point calculation error	
6	On	--	ECC=03400000	Instruction access page fault	
7	On	--	ECC=03470000	Data alignment error	
8	On	--	ECC=03600000	Data access page fault	
9	On	--	ECC=03660000	Data access protect error	
10	On	--	ECC=03E00000	System task table address acquisition error	Reload the CPMS. If the error occurs repeatedly, replace the hardware.
11	On	--	ECC=03E00001	System task startup error	
12	On	--	ECC=05700000	System down (system error)	
13	On	--	ECC=05700001	CP-side OS infinite loop detected	Reset the system. If the error occurs repeatedly, replace the hardware.
14	On	--	ECC=05700002	HP-side OS infinite loop detected	
15	On	--	ECC=05800000	System down (kernel trap)	Reload the CPMS. If the error occurs repeatedly, replace the hardware.
16	On	--	ECC=05900000	System down (CP Down)	Recover from the other errors that occurred at the same time.
17	On	--	ECC=05C70000	WDT timeout	Check and correct the user tasks, ladder programs, and HI-FLOW programs.
18	On	--	ECC=03820000	Memory error	Reset the system. If the error occurs repeatedly, replace the hardware.
19	On	--	ECC=03B60000	RI/O-IF module error	
20	On	--	ECC=03B80000	System bus error serious fault invalid interrupt status (ten times in a row)	Replace the hardware.
21	On	--	ECC=03B80001	CPU master access system bus error	Reset the system. If the error occurs repeatedly, replace the hardware.
22	On	--	ECC=03B90000	PCI bus error	
23	On	--	ECC=03BD0000	LSI internal timeout error	
24	On	--	ECC=03BE0000	SPU error	
25	On	--	ECC=03BF0000	RI/O error	
26	On	--	ECC=0500F001	Serious fault invalid interrupt status (ten times in a row)	Replace the hardware.
27	On	--	ECC=0500F003	PCI bus error serious fault invalid interrupt status (twice in a row)	
28	On	--	ECC=0500F004	CP to HP serious fault invalid interrupt status (twice in a row)	
29	On	--	ECC=0500F005	HP to CP serious fault invalid interrupt status (twice in a row)	
30	On	--	ECC=0500F00B	NPU serious fault invalid interrupt status (twice in a row)	

Table 13-3 CPU module troubleshooting (2/2)

No.	LED status		Indicator display#	Description	Recovery operation
	ERR LED	ALARM LED			
31	On	--	ECC=0D010001	Memory patrol error	Replace the hardware.
32	On	--	ECC=0D810000	BPU Error	
33	On	--	ECC=05140000	System down (built-in sub-stop)	Check and correct the embedded subroutines (see the <i>SIOVE Software Manual Operation RPD for Windows®</i> (manual number SEE-3-133)).

Table 13-4 OD.RING module troubleshooting

No.	CPU display			OD.RING display	Description	Recovery operation
	ERR LED	ALARM LED	Indicator display	ERR LED		
1	--	On	010100	On	OD.RING module switch setting error	Use the Module No. setting switch to set the appropriate value.
2	--	On	010101	On	OD.RING CPL switch setting error	Use the CPL No. setting switch to set the appropriate value.
3	--	On	010111	On	Duplicate OD.RING CPL No.	Specify the settings so that no CPL No. is duplicated.
4	--	On	010112	On	OD.RING parameter error (SUM value error)	Reconfigure the parameters.
5	--	On	010010	On	OD.RING bus error	Reset the system. If the same error message is displayed after a reset, the OD.RING module might be faulty. Replace the OD.RING module.
6	--	On	010011	On	OD.RING address error	
7	--	On	010012	On	OD.RING invalid instruction	
8	--	On	010013	On	OD.RING division-by-zero	
9	--	On	010014	On	OD.RING privilege violation	
10	--	On	010015	On	OD.RING WDT timeout error	
11	--	On	010016	On	OD.RING format error	
12	--	On	010017	On	OD.RING spurious interrupt	
13	--	On	010018	On	OD.RING unused exception	
14	--	On	010019	On	OD.RING parity error	
15	--	On	01001A	On	OD.RING GR notice	
16	--	On	010102	On	OD.RING ROM1 checksum error	
17	--	On	010103	On	OD.RING RAM1 compare error	
18	--	On	010105	On	OD.RING RAM2 compare error	
19	--	On	01010B	On	OD.RING ROM3 checksum error	
20	--	On	01010C	On	OD.RING ROM3 erase error (program)	
21	--	On	01010D	On	OD.RING ROM3 write error (program)	
22	--	On	01010E	On	OD.RING ROM3 erase error (parameter)	
23	--	On	01010F	On	OD.RING ROM3 write error (parameter)	
24	--	On	010110	On	OD.RING ROM rewrite count limit exceeded	

Table 13-5 FL.NET module troubleshooting (1/3)

No.	CPU display			FL.NET display		Description	Recovery operation	
	ERR LED	ALARM LED	Indicator display	LER LED	ERR LED			
1	--	On	027D10	--	On	FL.NET wrong setting error in the MAIN/SUB setting switch	Check and correct the setting of the MAIN/SUB setting switch.	
2	--	On	027D12	--	Blinking	FL.NET duplicate setting of the MAIN/SUB setting switch		
3	--	On	02010B	--	On	FL.NET ROM3 sum error	Reconfigure the parameters.	
4	--	On	020113	--	Blinking	FL.NET IP address not registered		
5	--	On	020201	--	Blinking	FL.NET duplicate common memory setting		
6	--	On	020202	On	Blinking	FL.NET duplicate node numbers		
7	--	On	020203	On	Blinking	FL.NET module setting error		
8	--	On	027512	--	On	FL.NET duplicate IP address error		
9	--	--	--	On	--	FL.NET token hold timeout		Check and correct the line load, or replace the FL.NET module.
10	--	--	--	--	On	FL.NET network participation not completed		Connect to the network.
11	--	On	020114	--	On	FL.NET MAC address not registered	Reset the system. If the same error message is displayed after a reset, the FL.NET module might be faulty. Replace the FL.NET module.	
12	--	On	023031	--	On	FL.NET instruction alignment error		
13	--	On	023041	--	On	FL.NET illegal instruction error		
14	--	On	023081	--	On	FL.NET privileged instruction error		
15	--	On	0230F9	--	On	FL.NET illegal exception error		
16	--	On	023389	--	On	FL.NET floating-point unavailable exception		
17	--	On	023391	--	On	FL.NET floating-point calculation error		
18	--	On	023401	--	On	FL.NET instruction access page fault		
19	--	On	023421	--	On	FL.NET instruction access error		
20	--	On	023461	--	On	FL.NET instruction access protection error		
21	--	On	023471	--	On	FL.NET data alignment error		
22	--	On	023601	--	On	FL.NET data access page fault		
23	--	On	023621	--	On	FL.NET data access error		
24	--	On	023661	--	On	FL.NET data access protection error		

Table 13-5 FL.NET module troubleshooting (2/3)

No.	CPU display			FL.NET display		Description	Recovery operation
	ERR LED	ALARM LED	Indicator display	LER LED	ERR LED		
25	--	On	023820	--	On	FL.NET memory error	Reset the system. If the same error message is displayed after a reset, the FL.NET module might be faulty. Replace the FL.NET module.
26	--	On	0238A0	--	On	FL.NET memory access error	
27	--	On	0238B0	--	On	FL.NET internal bus parity error	
28	--	On	0238C0	--	On	FL.NET system bus parity error	
29	--	On	0238F0	--	On	FL.NET undefined machine check error	
30	--	On	023B70	--	On	FL.NET bus target abort	
31	--	On	025000	--	On	FL.NET invalid interrupt	
32	--	On	025001	--	On	FL.NET undefined invalid interrupt	
33	--	On	025002	--	On	FL.NET INTEVT invalid interrupt	
34	--	On	025011	--	On	FL.NET RQI3 invalid status	
35	--	On	025012	--	On	FL.NET RQI3 invalid link status	
36	--	On	025013	--	On	FL.NET RQI3 invalid module status	
37	--	On	025031	--	On	FL.NET level 3 invalid interrupt status	
38	--	On	025032	--	On	FL.NET RQI6 invalid status	
39	--	On	025051	--	On	FL.NET RINT invalid status	
40	--	On	0250B1	--	On	FL.NET PUINT invalid status	
41	--	On	0250C1	--	On	FL.NET NINT invalid status	
42	--	On	0250F1	--	On	FL.NET serious fault invalid interrupt	
43	--	On	0250F2	--	On	FL.NET serious fault invalid interrupt 2	
44	--	On	0250F3	--	On	FL.NET bus error serious fault invalid interrupt status	
45	--	On	0250F6	--	On	FL.NET memory serious fault interrupt status invalid	
46	--	On	0250F7	--	On	FL.NET memory ECC 2-bit error serious fault invalid status	
47	--	On	0250F8	--	On	FL.NET RERR invalid interrupt status	
48	--	On	025110	--	On	FL.NET macro parameter error	
49	--	On	025130	--	On	FL.NET undefined macro issued	
50	--	On	025700	--	On	FL.NET system down (system error)	

Table 13-5 FL.NET module troubleshooting (3/3)

No.	CPU display			FL.NET display		Description	Recovery operation
	ERR LED	ALARM LED	Indicator display	LER LED	ERR LED		
51	--	On	025800	--	On	FL.NET system down (kernel trap)	Reset the system. If the same error message is displayed after a reset, the FL.NET module might be faulty. Replace the FL.NET module.
52	--	On	025C70	--	On	FL.NET WDT timeout	
53	--	On	027308	--	On	FL.NET transmission timeout error	
54	--	On	02730A	--	On	FL.NET hardware reset error	
55	--	On	02730E	--	On	FL.NET memory error	
56	--	On	027370	--	On	FL.NET PCI error detected by the communication LSI	
57	--	On	027400	--	On	FL.NET PCI bus error	
58	--	On	027505	--	On	FL.NET invalid interrupt generated from the line	
59	--	On	027510	--	On	FL.NET network interface initialization error	
60	--	On	027D01	--	On	FL.NET invalid exception generated	
61	--	On	027D13	--	On	FL.NET LANCE diagnosis error	
62	--	On	027D14	--	On	FL.NET SDRAM initialization error	
63	--	On	027D15	--	On	FL.NET ROM checksum error (CPMS)	
64	--	On	027D18	--	On	FL.NET ROM checksum error (communication task)	
65	--	On	02D010	--	On	FL.NET memory 1-bit error (solid)	
66	--	On	02D330	--	On	FL.NET hardware WDT timeout	
67	--	On	02D340	--	On	FL.NET software WDT timeout	
68	--	On	02D810	--	On	FL.NET BPU error	

Table 13-6 J.NET module troubleshooting

No.	CPU display			J.NET display	Description	Recovery operation
	ERR LED	ALARM LED	Indicator display	ERR LED		
1	--	On	030100	On	J.NET module switch setting error	Check the setting of the Module No. setting switch. Check the setting of the bit rate setting switch. Reconfigure the parameters. Reset the system. If the same error message is displayed after a reset, the J.NET module might be faulty. Replace the J.NET module.
2	--	On	030101	On	J.NET bit rate switch setting error	
3	--	On	030112	On	J.NET parameter error (SUM error)	
4	--	On	030010	On	J.NET bus error	
5	--	On	030011	On	J.NET address error	
6	--	On	030012	On	J.NET invalid instruction	
7	--	On	030013	On	J.NET division-by-zero	
8	--	On	030014	On	J.NET privilege violation	
9	--	On	030015	On	J.NET WDT timeout error	
10	--	On	030016	On	J.NET format error	
11	--	On	030017	On	J.NET spurious interrupt	
12	--	On	030018	On	J.NET unused exception	
13	--	On	030019	On	J.NET parity error	
14	--	On	030102	On	J.NET ROM1 checksum error	
15	--	On	030103	On	J.NET RAM1 compare error	
16	--	On	030105	On	J.NET RAM2 compare error	
17	--	On	030107	On	J.NET DMA1 transfer error (transmission)	
18	--	On	030108	On	J.NET DMA2 transfer error (transmission)	
19	--	On	030109	On	J.NET DMA1 transfer error (reception)	
20	--	On	03010A	On	J.NET DMA2 transfer error (reception)	
21	--	On	03010B	On	J.NET ROM3 sum error	
22	--	On	03010C	On	J.NET ROM erase error (program)	
23	--	On	03010D	On	J.NET ROM write error (program)	
24	--	On	03010E	On	J.NET ROM erase error (parameter)	
25	--	On	03010F	On	J.NET ROM write error (parameter)	
26	--	On	030110	On	J.NET ROM rewrite count limit exceeded	

Table 13-7 D.NET module troubleshooting

No.	CPU display			D.NET display		Description	Recovery operation
	ERR LED	ALARM LED	Indicator display	MS LED	NS LED		
1	--	On	04140A	Green	Green	D.NET module switch setting error	Check the setting value of the MODU No. setting switch.
2	--	On	044181	Red	--	D.NET MAC ID duplicate (other node stopped)	Check the node address settings.
3	--	On	044281	Red	--	D.NET MAC ID duplicate (local node stopped)	
4	--	On	045188	Green	Green	D.NET transmission word count setting error	When the communication speed was set to 500 kbps or 250 kbps, transmission of 17 frames or more over a 10 ms interval was set. When 125 kbps was set, transmission of 9 frames or more over a 10 ms interval was set. Revise the communication parameters.
5	--	On	045189	Green	Green	D.NET parameter error (SUM value error)	Reconfigure the communication parameters.
6	--	On	041401	Red	--	D.NET MPU register compare error	Reset the system. If the same error message is displayed after a reset, the D.NET module might be faulty. Replace the D.NET module.
7	--	On	041402	Red	--	D.NET MPU operation check error	
8	--	On	041403	Red	--	D.NET CAN register compare check error	
9	--	On	041405	Red	--	D.NET FROM compare check error	
10	--	On	041406	Red	--	D.NET FROM checksum error (microprogram)	
11	--	On	041407	Red	--	D.NET SRAM compare check error	
12	--	On	041409	Red	--	D.NET MPU built-in timer diagnosis error	
13	--	On	04140D	Red	--	D.NET FROM checksum error (parameter)	
14	--	On	042404	Red	--	D.NET watchdog timer timeout error	
15	--	On	043400	Red	--	D.NET undefined interrupt generated	
16	--	On	043404	Red	--	D.NET general illegal instruction	
17	--	On	043406	Red	--	D.NET slot illegal instruction	
18	--	On	043409	Red	--	D.NET address error	

Table 13-8 ET.NET module troubleshooting (1/2)

No.	CPU display			ET.NET display		Description	Recovery operation
	ERR LED	ALARM LED	Indicator display	ERR LED	ALARM LED		
1	--	On	0E7D12	--	On	ET.NET duplicate MAIN/SUB switch setting	Check and correct the setting of the MAIN/SUB setting switch.
2	--	On	0E7D1A	--	On	ET.NET MAIN/SUB switch setting error	Check and correct the setting of the MAIN/SUB setting switch.
3	--	On	0E7D1B	--	On	ET.NET ST.no. switch setting error	Check and correct the setting of the ST.No. setting switch.
4	--	On	0E7D1C	--	On	ET.NET communication setting undefined	Specify the communication settings.
5	--	On	0E7512	--	On	ET.NET duplicate IP address error (system setup setting error detected on startup)	Check and correct the IP address settings.
6	--	On	0E7512	--	--	ET.NET duplicate IP address error (system setup setting error detected when online)	Check and correct the IP address settings.
7	--	On	0E7510	--	On	ET.NET network driver initialization error	Check and correct the communication settings.
8	--	On	0E7511	--	On	ET.NET duplicate network address error (system setup setting error)	Check and correct the network settings.
9	--	On	0E3031	On	--	ET.NET instruction alignment error	Reset the system. If the same error message is displayed after a reset, the ET.NET module might be faulty. Replace the ET.NET module.
10	--	On	0E3041	On	--	ET.NET illegal instruction error	
11	--	On	0E3081	On	--	ET.NET privileged instruction error	
12	--	On	0E30F9	On	--	ET.NET illegal exception error	
13	--	On	0E3389	On	--	ET.NET floating-point unavailable exception	
14	--	On	0E3391	On	--	ET.NET floating point operation error	
15	--	On	0E3401	On	--	ET.NET instruction access page fault	
16	--	On	0E3421	On	--	ET.NET instruction access error	
17	--	On	0E3461	On	--	ET.NET instruction access protection error	
18	--	On	0E3471	On	--	ET.NET data alignment error	
19	--	On	0E3601	On	--	ET.NET data access page fault	
20	--	On	0E3621	On	--	ET.NET data access error	
21	--	On	0E3661	On	--	ET.NET data access protection error	
22	--	On	0E3820	On	--	ET.NET memory error	
23	--	On	0E3B70	--	--	ET.NET bus target abort	

Table 13-8 ET.NET module troubleshooting (2/2)

No.	CPU display			ET.NET display		Description	Recovery operation
	ERR LED	ALARM LED	Indicator display	ERR LED	ALARM LED		
24	--	On	0E3B81	On	--	System bus error (access from ET.NET module)	Reset the system. If the same error message is displayed after a reset, the ET.NET module might be faulty. Replace the ET.NET module.
25	--	On	0E3B82	On	--	System bus error (access to ET.NET module)	
26	--	On	0E3B90	On	--	ET.NET PCI bus error	
27	--	On	0E5001	On	--	ET.NET undefined invalid interrupt	
28	--	On	0E5002	On	--	ET.NET INTEVT invalid interrupt	
29	--	On	0E50F1	On	--	ET.NET serious fault invalid interrupt	
30	--	On	0E50F2	On	--	ET.NET serious fault invalid interrupt 2	
31	--	On	0E50F3	On	--	ET.NET bus error serious fault invalid interrupt status	
32	--	On	0E50F6	On	--	ET.NET memory serious fault invalid interrupt status	
33	--	On	0E50F7	On	--	ET.NET memory ECC 2-bit error serious fault invalid interrupt status	
34	--	On	0E50F8	On	--	ET.NET RERR invalid interrupt status	
35	--	On	0E5110	On	--	ET.NET macro parameter error	
36	--	On	0E5130	On	--	ET.NET undefined macro issued	
37	--	On	0E5700	On	--	ET.NET system down (system error)	
38	--	On	0E5700	On	--	ET.NET system down (ULSUB STOP)	
39	--	On	0E5800	On	--	ET.NET system down (kernel trap)	
40	--	On	0E5C70	On	--	ET.NET watchdog timeout	
41	--	On	0E7308	On	--	ET.NET transmission timeout error	
42	--	On	0E730A	On	--	ET.NET hard reset error	
43	--	On	0E7505	On	--	ET.NET invalid interrupt generated from the line	
44	--	On	0E7D01	On	--	ET.NET invalid exception generated	
45	--	On	0E7D11	On	--	ET.NET MAC address error	
46	--	On	0E7D13	On	--	ET.NET LANCE diagnosis error	
47	--	On	0E7D14	On	--	ET.NET SDRAM initialization error	
48	--	On	0E7D18	On	--	ET.NET ROM checksum error	
49	--	On	0ED010	On	--	ET.NET memory 1-bit error (solid)	
50	--	On	0ED810	On	--	ET.NET BPU error	

13.2 Troubleshooting individual modules

13.2.1 CPU module troubleshooting

If the ERR LED of the CPU module is on, follow the instructions in Table 13-2 to troubleshoot the problem.

If the ERR LED is off, troubleshoot the problem according to the following instructions.

(1) Troubleshooting transient hardware failures

Check the BASE SYSTEM/S10VE error log, and then follow the instructions in Table 13-9 to troubleshoot the problem.

Table 13-9 Troubleshooting transient hardware failures (1/3)

No.	Contents of the BASE SYSTEM/S10VE error log		Description	Recovery operation
	Error code	Error message		
1	03B70000	System Bus Error (Master/Target Abort)	Bus target abort	Replace the CPU module.
2	03B80002	System Bus Error (CPU Target)	CPU target access system bus error	
3	03D00002	Ladder Program error (Stack Overflow)	Stack overflow error	
4	03D00003	Ladder Program error (Illegal Instruction)	Illegal instruction error	
5	03D00004	Ladder Program error (FP Program Error)	Floating-point operation error	
6	03D00006	Ladder Program error (Illegal SH Instruction)	SH illegal instruction error	
7	03D01101	Ladder Program error (P-Coil CP DOWN Detect)	P coil CP down detected	
8	03D0120A	Ladder Program error (Illegal User Function)	User operation function address error	
9	03D01212	Ladder Program error (Ladder Table Empty)	Table not registered	Reload the CPMS. If the error occurs repeatedly, replace the CPU module.
10	03D01214	Ladder Program error (Illegal Factor)	Initiation factor error	
11	05000000	Module Error (Invalid Interrupt)	Invalid interrupt	Replace the CPU module.
12	05000001	Module Error (Undefined Interrupt)	Undefined invalid interrupt	
13	05000002	Module Error (INTEVT Invalid Interrupt)	INTEVT invalid interrupt	
14	05001001	Module Error (RQI3 INF Invalid Interrupt)	RQI3 invalid interrupt status	

Table 13-9 Troubleshooting transient hardware failures (2/3)

No.	Contents of the BASE SYSTEM/S10VE error log		Description	Recovery operation
	Error code	Error message		
15	05001002	Module Error (RQI3 Sub-OS registration error)	RQI3 sub-OS registration error	Replace the CPU module.
16	05001011	Module Error (RI/O INTR Invalid Interrupt)	RI/O invalid interrupt status	
17	05003001	Module Error (LV3 INTST Invalid Interrupt)	Level 3 invalid interrupt status	
18	05003002	Module Error (RQI6 INF Invalid Interrupt)	RQI6 invalid status	
19	05004001	Module Error (RINTR Invalid Interrupt)	RINT invalid status	
20	05006001	Module Error (SPU INTR Invalid Interrupt)	SPU invalid interrupt status	
21	0500A001	Module Error (NINTR Invalid Interrupt)	NINT invalid status	
22	0500B001	Module Error (PUINTR Invalid Interrupt)	PUINT invalid status	
23	0500F001	Module Error (HERST Invalid Interrupt)	Serious fault invalid interrupt	
24	0500F002	Module Error (HERST Invalid Interrupt(2))	Serious fault invalid interrupt 2	
25	0500F003	Module Error (BUERRSTAT Invalid Interrupt)	PCI bus error serious fault invalid interrupt status	
26	0500F004	Module Error (P2NHERREQ Invalid Interrupt)	CP to HP serious fault invalid interrupt status	
27	0500F005	Module Error (N2PHERREQ Invalid Interrupt)	HP to CP serious fault invalid interrupt status	
28	0500F006	Module Error (NHPMCLG Invalid Interrupt)	Memory serious fault invalid interrupt status	
29	0500F007	Module Error (ECC 2bit Master Invalid Interrupt)	Memory ECC 2 bit error serious fault invalid status	
30	0500F008	Module Error (RERRMST Invalid Interrupt)	PERR invalid interrupt status	
31	0500F009	Module Error (Invalid P2NHERR Interrupt (CP Alive))	CP to HP serious fault invalid interrupt	
32	0500F00B	Module Error (NP_ERRLOGMP Invalid Interrupt)	NPU serious fault invalid interrupt	
33	0500F00C	Module Error (SPU HERR Invalid Interrupt)	SPU serious fault invalid interrupt	

Table 13-9 Troubleshooting transient hardware failures (3/3)

No.	Contents of the BASE SYSTEM/S10VE error log		Description	Recovery operation
	Error code	Error message		
34	0500F00D	Module Error (RIO HERR Invalid Interrupt)	RI/O serious fault invalid interrupt	Replace the CPU module.
35	05110000	Module Error (Macro Parameter Error)	Failure to issue a macro to a PU other than itself	
36	05A00001	Kernel warning	Clock synchronization (>15sec)	
37	05C70005	Program error (Program WDT Timeout Error)	WDT timeout error	Reload the CPMS. If the error occurs repeatedly, replace the CPU module.
38	07395020	I/O error (ROM (NANDF) Error)	ROM (NAND-Flash) memory access failure	Replace the CPU module.
39	0739D001	Module Error (RQI6 Interrupt Received)	RQI6 interrupt generated	
40	0739D002	Module Error (RQI6 Interrupt Factor (ISW6) Clear Error)	RQI6 interrupt request clear error	
41	07801308	I/O error (SEND_TIMEOUT)	Transmission timeout error	
42	0780130A	I/O error (RESET_ERROR)	Hardware reset error	
44	07801311	I/O error (RETRY)	Retry error	
45	07801312	I/O error (LATE)	Late collision error	Check and correct the transmission line.
46	07801505	I/O error (INV_INTR)	Invalid interrupt generated (detected by OS)	Replace the CPU module.
47	0D010000	Module Error (Memory Alarm)	Memory 1-bit error (solid)	
48	0D300010	Module Error (Primary Battery Error)	Primary battery error	
49	0D320000	Module Error (Memory Error)	Memory error	
50	0D330000	Module Error (Hardware WDT timeout)	Hardware WDT timeout	
51	0D360000	Module Error (ROM Sum Check Error)	ROM checksum error	
52	0D370000	Module Error (External Error)	External error	
53	0D390000	Module Error (Clock Stop Error)	Clock stop error	
54	0D800000	Module Error (TOD Error)	Backup clock error	
55	51000001	Module Error (System Register Clear Time Out)	System register initialization timeout error	Replace the CPU module.

(2) Troubleshooting user programs

Check the BASE SYSTEM/S10VE error log, and then follow the instructions in Table 13-10 to troubleshoot the problem.

Table 13-10 User program troubleshooting (1/2)

No.	Contents of the BASE SYSTEM/S10VE error log		Description	Recovery operation
	Error code	Error message		
1	03030000	Program error (Inst. Alignment Error)	Instruction alignment error	Check and review the user tasks. ^{#1}
2	03040000	Program error (Illegal Instruction)	Illegal instruction error	
3	03080000	Program error (Privileged Instruction)	Privileged instruction error	
4	03390000	Program error (FP Program Error)	Floating-point calculation error	
5	03400000	Program error (Instruction Page Fault)	Instruction access page fault	
6	03420000	Program error (Invalid Inst. Access)	Instruction access error	
7	03460000	Program error (Inst. Access Protection)	Instruction access protect error	
8	03470000	Program error (Data Alignment Error)	Data alignment error	
9	03600000	Program error (Data Page Fault)	Data access page fault	
10	03620000	Program error (Invalid Data Access)	Data access error	
11	03660000	Program error (Data Access Protection)	Data access protect error	
12	03B70001	System Bus Error (S10 Bus DTACK Timeout)	Timeout detected when the CPU accessed the S10 bus	No action is required. (This is not an error.)
13	03D00001	Ladder Program error (Data Access Protection)	Data access protect error	Check and correct the ladder program.
14	03D01208	Ladder Program error (N-Coil Nesting Over)	N coil overflow error	
15	03D0120C	Ladder Program error (Illegal Function Parameter)	System operation function parameter error	
16	03D01210	Ladder Program error (Ladder Area Sum Mismatch)	Ladder area SUM error	Reload the ladder program.
17	05110000	Macro parameter error	Macro parameter error	Check and review the user tasks. ^{#1}

Table 13-10 User program troubleshooting (2/2)

No.	Contents of the BASE SYSTEM/S10VE error log		Description	Recovery operation
	Error code	Error message		
18	05130000	Macro parameter error	Issuing of undefined-macro	Reload the CPMS. If the error occurs repeatedly, replace the CPU module.
19	07801310	I/O error (LOSS)	Carrier loss error	Check and correct the program. ^{#2}
20	07801508	I/O error (BUF_OVF)	Overflow of transmission/reception buffer managed by OS	Check and correct the system design. ^{#3}
21	0780150D	I/O error (STATION_NUM)	System configuration error detected by OS (mismatch in station number)	Check and correct the system configuration.
22	0780150F	I/O error (SOCKET_OVF)	Socket table overflow (detected by OS)	
23	07801510	I/O error (IFCONFIG_UP)	Initialization error (detected by OS)	
24	07801511	I/O error (NETADDR_DUPL)	Duplicate network address error (detected by OS)	Check and correct the system configuration. ^{#4}
25	07801512	I/O error (IPADDR_DUPL)	Duplicate IP address error (detected by OS)	Check and correct the system configuration. ^{#5}
26	0D340000	Module Error (Software WDT Timeout)	Software WDT timeout	Check and correct the program. If the error occurs repeatedly, replace the hardware.
27	0D350000	Module Error (RAM Sum Check Error)	RAM checksum error	
28	51000000	Module Error (Optional Module startup check error)	Optional module startup check error	Reset the system. If the error occurs repeatedly, replace the optional module.
29	51000002	Module Error (Optional Parameter size Error)	Optional module parameter size error	Reset the system. Check and correct the parameters. If the error occurs repeatedly, replace the optional module.
30	00000201	Message frame error	Message frame error	Check and correct the sender node and system configuration.
31	00000401	Buffer status	Buffer status report	Check and correct the number of send/receive buffer.
32	00000501	Socket error	Socket error	Check and correct the system configuration.
33	00000601	Transfer memory address error	Transfer area duplication error	Revise the transfer send address.

- #1: See the *SIOVE Software Manual Operation RPDP for Windows®* (manual number SEE-3-133).
- #2: This error occurs when the LINK LED of the CPU module is off (the link is not established) and a data transmission request is received from the application program.
- #3: This occurs due to an insufficient buffer when a heavy communication load is present. Check and correct the system design, such as by increasing the system configuration (net_unit.u:MBUF_CNT).
- #4: Check and correct the system configuration (adapter.u) so that each of the built-in Ethernet network addresses is uniquely defined.
- #5: The IP address is duplicated with another computer. The system configuration (adapter.u) needs to be checked and corrected.

13.2.2 Troubleshooting optional modules

13.2.2.1 OD.RING module troubleshooting

If the ERR LED of the OD.RING module is on, follow the instructions in Table 13-4 to troubleshoot the problem. If the ERR LED is off, troubleshoot the problem according to the following instructions.

(1) Troubleshooting from the TX LED and RX LED

Check whether the TX LED and RX LED of the OD.RING module are on or off, and then follow the instructions in Table 13-11 to troubleshoot the problem.

Table 13-11 Troubleshooting from the transmission LED (TX) and the reception LED (RX)

LED status	Check	Corrective action
The transmission LED (TX) is off.	Is the reception LED (RX) on?	If the reception LED (RX) is on, the module might have failed. See Table 13-2.
The transmission LED (TX) is off and the reception LED (RX) is on for all modules.	Is the optical fiber cable connected properly?	Verify that the optical fiber cable is connected properly.
	Is the optical fiber cable connector inserted properly?	Verify that the optical fiber cable connector is inserted with its key aligned with the matching slot.
The reception LED (RX) is off.	Is the transmission LED (TX) on?	If the transmission LED (TX) is off, see <i>The transmission LED (TX) is off</i> .
	Are the optical fiber cables connected properly?	Verify that the optical fiber cables are connected as described in 3.3 <i>Wiring</i> in the <i>SIOVE User's Manual Option OD.RING (LQE510-E)</i> (manual number SEE-1-101).
	Is an optical fiber cable disconnected or bent?	The recommended minimum bending radius of an optical fiber cable is 30 mm. If you bend an optical fiber cable more sharply than the minimum specified bending radius, communication over the cable becomes impossible. Use a cable recommended in 3.4.3 <i>Recommended cables</i> in the <i>SIOVE User's Manual Option OD.RING (LQE510-E)</i> (manual number SEE-1-101).
	Is the module at the other end transmitting data?	If the module at the other end is not transmitting data, the reception LED (RX) does not turn on.

(2) Troubleshooting from sent and received data

If errors occur in data sent and received, such as the inability to send or receive data to and from other OD.RING modules or the corruption of data, follow the instructions in Table 13-12 to troubleshoot the problem.

Table 13-12 Troubleshooting from sent and received data (1/2)

Sent and received data	Check	Corrective action
Data is not transferred from the module at the other end.	Is the power of the module at the other end turned on?	If the power has not been turned on, turn it on.
	Is the module at the other end transmitting data?	If the transmission LED (TX) is off and the reception LED (RX) is on, the module might have failed. See Table 13-2.
	Is the switch on the module at the other end set to "RUN"?	When the LADDER RUN/STOP switch on a CPU module is set to STOP, memory transfer is disabled.
	Are the transmission area settings of the module at the other end correct?	If the transmission area settings are not correct, specify the correct settings. If the transmission word count is set to 0, transmission is disabled.
	Are the Module No. and CPL No. settings correct?	Verify that the set values are correct. The Module No. setting switch and the CPL No. setting switch are related based on the number of connected devices. (See 4.2 Setting switches in the <i>SIOVE User's Manual Option OD.RING (LQE510-E)</i> (manual number SEE-1-101). If duplicate settings are used, data is not transferred properly.
Data is not transferred to the module at the other end.	Is the LADDER RUN/STOP switch on the CPU module set to "RUN"?	When the LADDER RUN/STOP switch on a CPU module is set to STOP, memory transfer is disabled.
	Are the transmission area settings of the module at this end correct?	If the transmission area settings are not correct, specify the correct settings. If the transmission word count is set to 0, transmission is disabled.
	Are the Module No. and CPL No. settings correct?	Verify that the set values are correct. The Module No. setting switch and the CPL No. setting switch are related based on the number of connected devices. (See 4.2 Setting switches in the <i>SIOVE User's Manual Option OD.RING (LQE510-E)</i> (manual number SEE-1-101). If duplicate settings are used, data is not transferred properly.

Table 13-12 Troubleshooting from sent and received data (2/2)

Sent and received data	Check	Corrective action
Data in a transfer area is corrupted.	Are the transmission area settings of the module that performs data transfer correct?	If the transmission area settings are not correct, specify the correct settings.
	Are multiple modules using overlapping transmission areas?	If transmission areas overlap, data in the overlapping parts is corrupted.
	Is a user program updating a transfer area?	Stop user programs and check whether they are updating a transfer area.
Transferred data is cleared to 0.	Is the module that transmits data stopped?	If the hold/clear mode is set to clear, the transfer area is cleared to 0 when data transmission is stopped.
	Is the LADDER RUN/STOP switch of the CPU module that transmits data set to "STOP"?	If the LADDER RUN/STOP switch of the CPU module is set to "STOP", the data transmission for the transfer area stops. If the hold/clear mode is set to clear at this time, the transfer area is cleared to 0.

(3) Troubleshooting from the status of communication with another node

You can verify the status of communication with another node by checking the RAS information.

For details about checking the RAS information, see 5.6 *RAS table* in the *S10VE User's Manual Option OD.RING (LQE510-E)* (manual number SEE-1-101).

(4) Error freeze

When an OD.RING module detects a hardware error, the ERR LED turns on, and error freeze information is saved. The OD.RING module then stops operating.

Figure 13-2 shows the format of the error freeze information. For information about error codes and the stack frame in the following format, see the following pages.

System bus address		2 ³¹ ——— 2 ¹⁶	2 ¹⁵ ——— 2 ⁰
Main	Sub		
/940400	/9C0400	Error code	————
		————	
/940410	/9C0410	D0 register	
/940414	/9C0414	D1 register	
/940418	/9C0418	D2 register	
/94041C	/9C041C	D3 register	
/940420	/9C0420	D4 register	
/940424	/9C0424	D5 register	
/940428	/9C0428	D6 register	
/94042C	/9C042C	D7 register	
/940430	/9C0430	A0 register	
/940434	/9C0434	A1 register	
/940438	/9C0438	A2 register	
/94043C	/9C043C	A3 register	
/940440	/9C0440	A4 register	
/940444	/9C0444	A5 register	
/940448	/9C0448	A6 register	
/94044C	/9C044C	A7 register	
/940450	/9C0450	Stack frame (4 words, 6 words, bus error)	

Figure 13-2 Error freeze information format

13. Troubleshooting

Table 13-13 shows the error codes that can be stored in the *Error code* field in Figure 13-2. Normally, /0000 is stored in the *Error code* field.

Table 13-13 Error codes

Code	Error	Corrective action
/0010	Bus error	The module might have failed. Replace the module.
/0011	Address error	
/0012	Invalid instruction	
/0013	Division by zero	
/0014	Privilege violation	
/0015	WDT error	
/0016	Format error	
/0017	Spurious interrupt	
/0018	Unused exception	
/0019	Parity error	
/001A	GR notice	
/0100	Incorrectly set Module No. setting switch	Correct the setting.
/0101	Wrong setting of the CPL No. setting switch	
/0102	ROM1 sum error	The module might have failed. Replace the module.
/0103	RAM compare error	
/0105		
/010B	ROM3 sum error	
/010C	ROM3 micro erase error	
/010D	ROM3 micro write error	
/010E	ROM3 parameter erase error	
/010F	ROM3 parameter write error	
/0111	Duplicate CPL No.	Correct the setting.
/0112	Parameter error	Reconfigure the parameters.

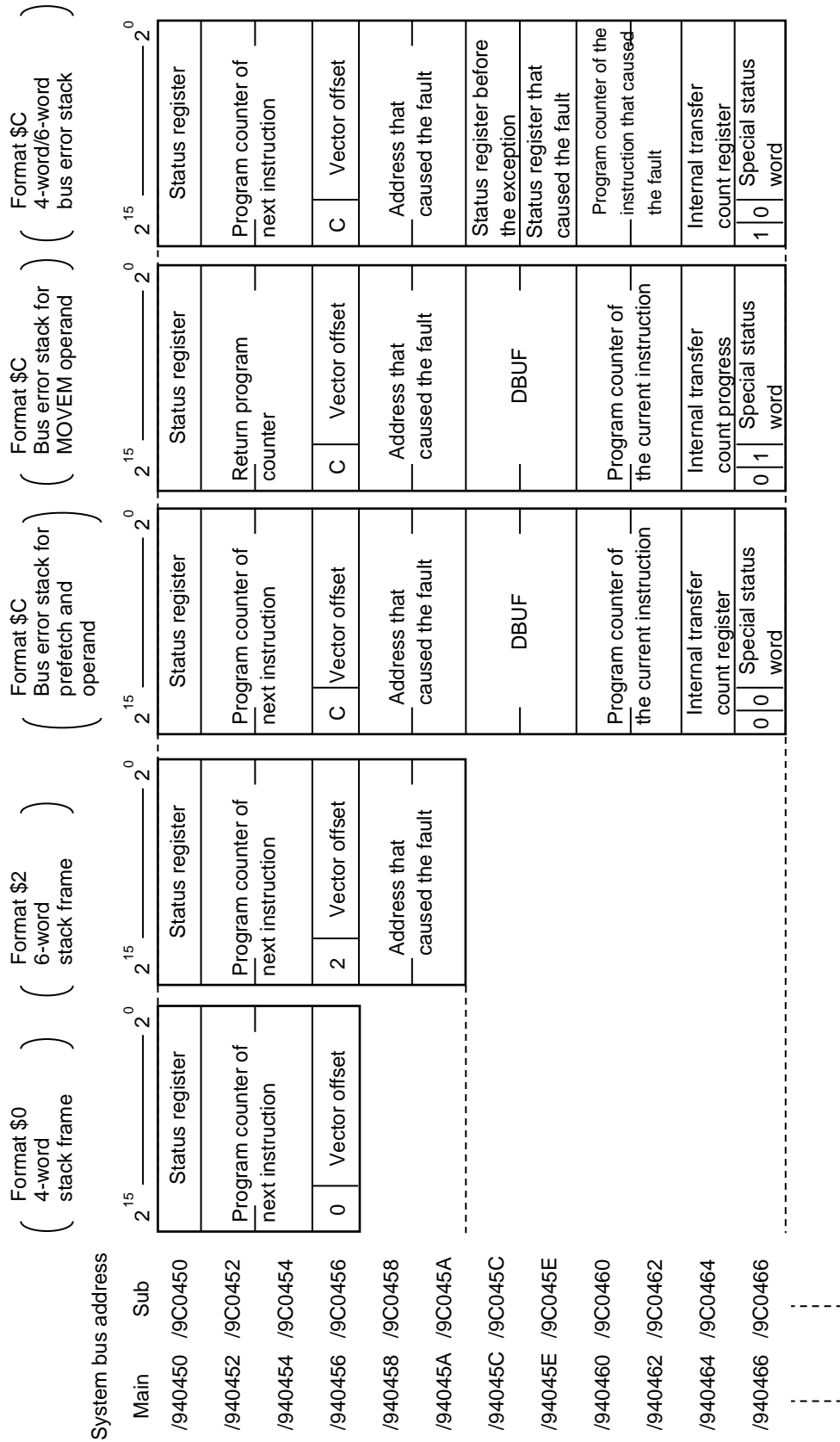

Figure 13-3 Stack frame format

13. Troubleshooting

(5) Communication trace

OD.RING modules have a function for tracing communicated information and content. You can use this function when a failure occurs to generate trace data to help investigate the cause of the failure and take corrective action.

- Configuration of the trace buffer

The trace buffer consists of an 8-word-long trace control table and 256 cases (with 32 words per case) of trace data. A pointer is used to store trace data cyclically.

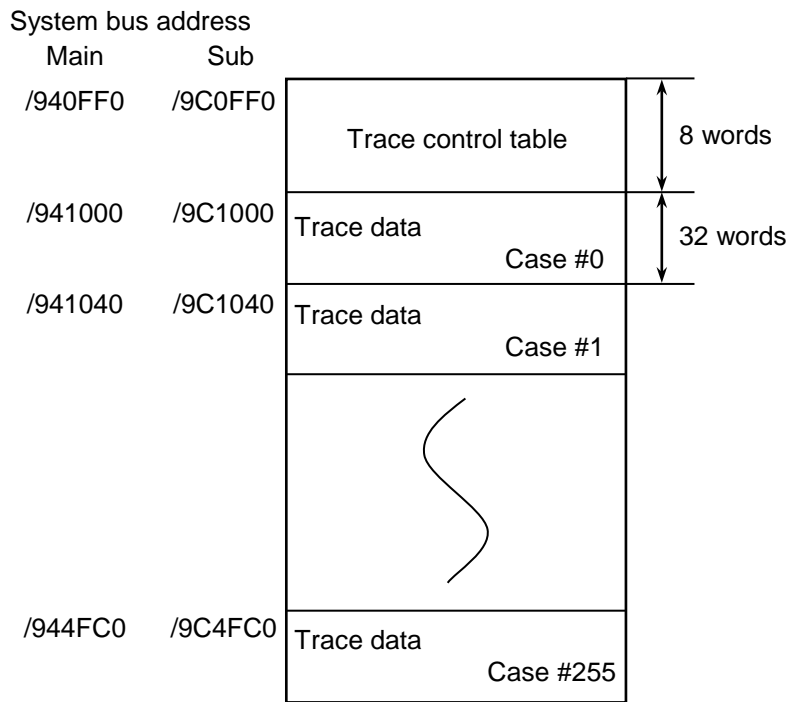

Figure 13-4 Trace buffer

Trace data is stored in case-number order, starting from case #0. After trace data is stored in the last case (case #255), the next trace data is stored in case #0 again.

- Trace control table

The trace control table consists of 8 words.

System bus address		
Main	Sub	
/940FF0	/9C0FF0	[1] Run/stop
/940FF2	/9C0FF2	Reserved
/940FF4	/9C0FF4	[2] Tracing address
/940FF8	/9C0FF8	[3] Mask data
/940FFA	/9C0FFA	[4] Comparison
/940FFC	/9C0FFC	[5] Pointer
/940FFE	/9C0FFE	Reserved

Figure 13-5 Trace control table

[1] Run/stop

Specify whether to run or stop the trace.

0: The trace stops.

1: The trace runs until the trace conditions are met.

2: The trace runs until the trace conditions are met or an error occurs.

When power is restored to the module or the module recovers from a reset, the setting is "2".

When an error occurs or the trace conditions are met, the trace stops and the setting becomes "0".

[2] Tracing address

Specify the start address of the area to be monitored by the conditional trace.

[3] Mask data

Specify the mask data to be used by the conditional trace.

Only bits set to "0" in the bit data are masked.

[4] Comparison data

Specify the comparison data to be used by the conditional trace.

The data from the tracing address of [2] is ANDed with the mask data of [3] and compared against the comparison data. If the two values are the same, the trace conditions are met.

[5] Pointer

Specifies the case used to store subsequent trace data.

13. Troubleshooting

Usage example 1:

To stop the trace when G002, which is supposed to always be "1", becomes "0", use the settings shown in Figure 13-6.

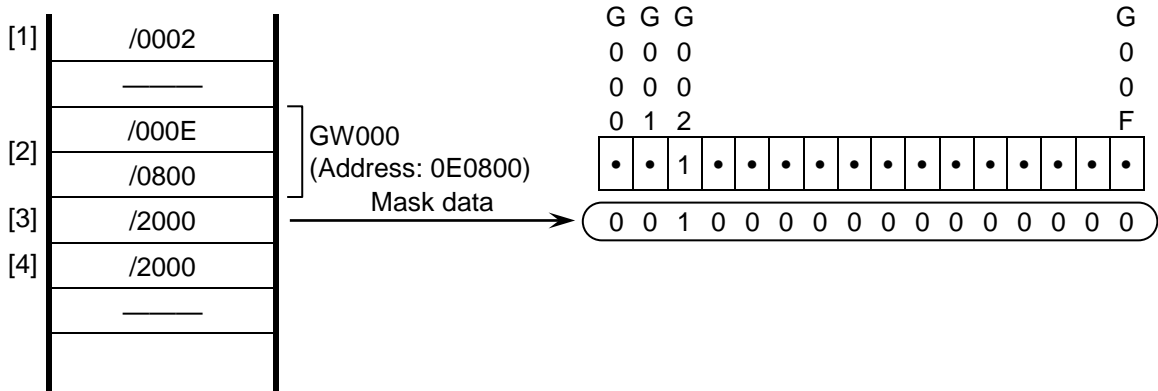

Figure 13-6 Usage example 1

Usage example 2:

To stop the trace when FW000, which is supposed to always be "1234", becomes "1111", use the settings shown in Figure 13-7.

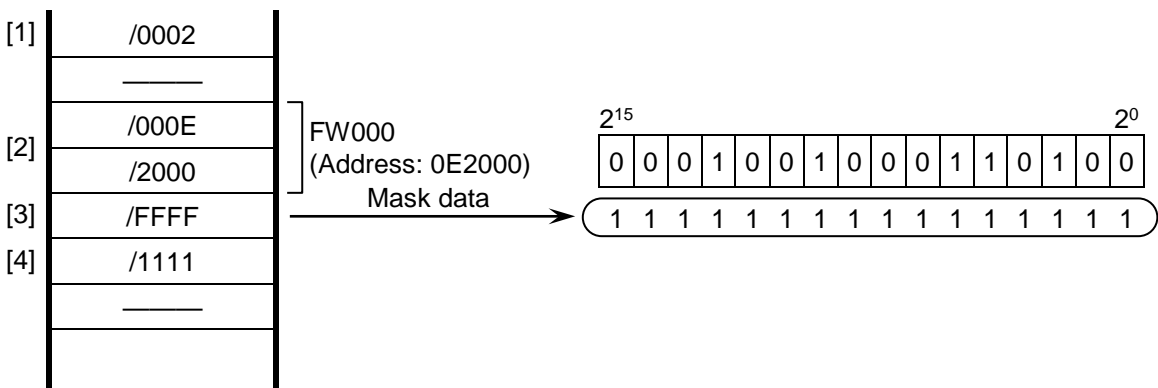

Figure 13-7 Usage example 2

(6) Trace data

Trace data consists of 32 words per case.

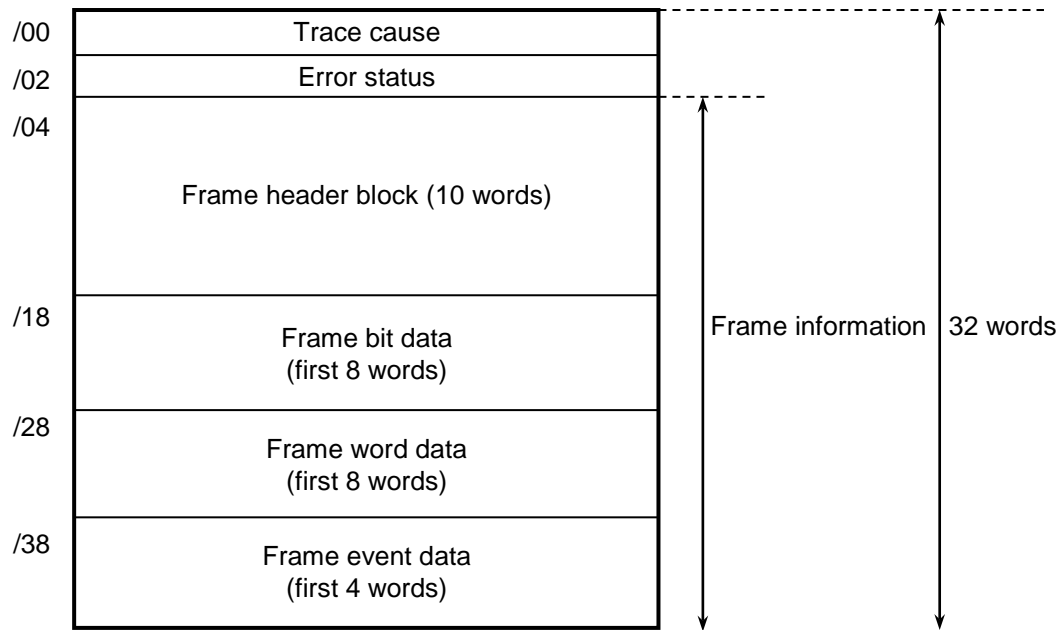

Figure 13-8 Trace data

Details of the frame header block

	15	8	7	0
/04	Destination CPL No.		Sender CPL No.	
/06	Total number of bytes in the frame			
/08	Number of bytes in the bit data			
/0A	Number of bytes in the word data			
/0C	Number of bytes in the event data			
/0E	CPU status			
/10	Address of the _____ bit area			
/14	Address of the _____ byte area			

Figure 13-9 Frame header block

13. Troubleshooting

(7) Trace events and executed trace processing

Table 13-14 shows a list of events that generate trace data and the processing performed in response to each event.

Table 13-14 Trace events and processing

Event	Condition check	Error stop	Trace cause	Error status	Frame information
Transmission started	Yes	No	Valid	Invalid	Valid
Transmission successfully completed	No	No	Valid	Invalid	Invalid
Transmission terminated with error	No	Yes	Valid	Valid	Invalid
Transmission timeout	No	Yes	Valid	Invalid	Invalid
Reception started	No	No	Valid	Invalid	Invalid
Reception successfully completed	Yes	No	Valid	Invalid	Valid
Reception terminated with error	Yes	Yes	Valid	Valid	Valid
Reception timeout	No	Yes	Valid	Valid	Valid

- Condition check

The trace conditions are checked to determine whether to stop the communication trace. When a trace condition is met, the condition-met flag in the trace condition is set, and the trace stops.

- Error stop

If the run/stop setting is "2", processing is performed to stop the communication trace when an error occurs.

- Trace cause

The cause of the generation of the trace data is set in the trace cause.

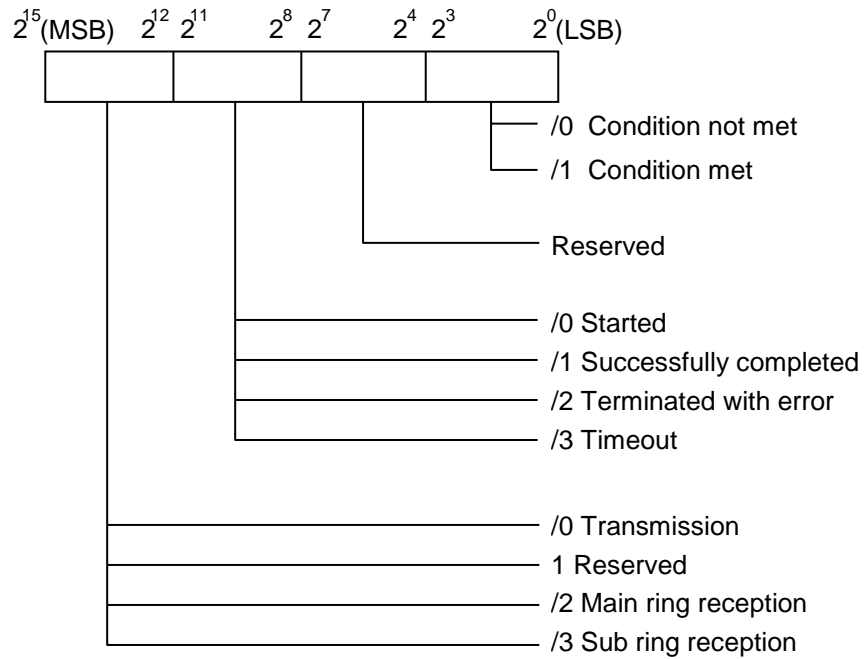

Figure 13-10 Trace cause

- Error status

Transmission error status

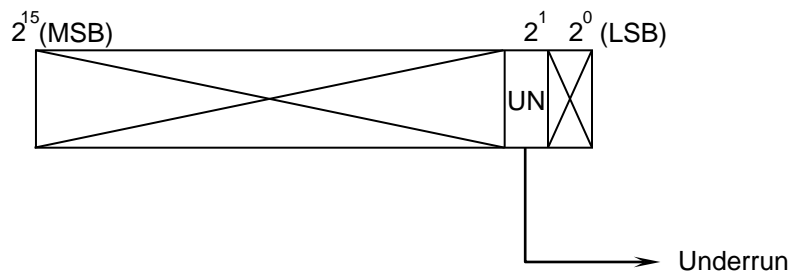

Figure 13-11 Transmission error status

13. Troubleshooting

Reception error status

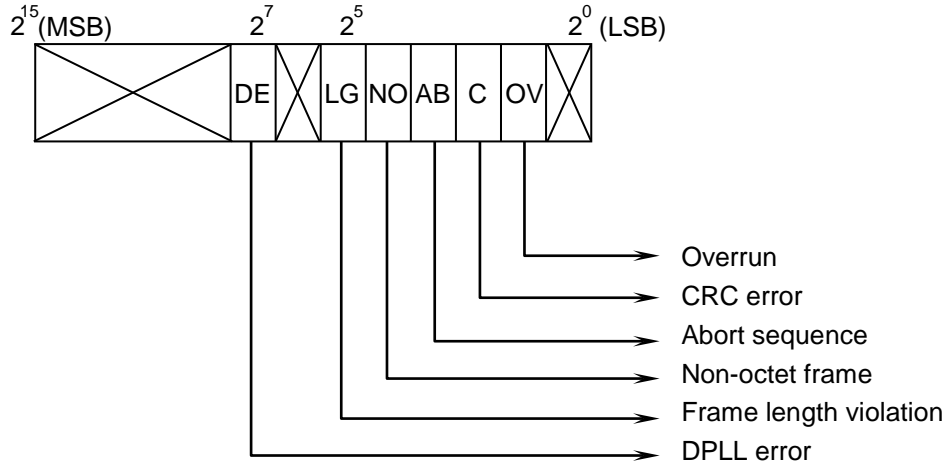

Figure 13-12 Reception error status

Note: When a reception timeout error occurs, the error status is set to "FFFF".

Table 13-15 shows the details of each error status.

Table 13-15 Error status details

Transmission or reception	Error name	Error description
Transmission	Underrun	A transmitter underrun occurred during transmission.
Reception	DPLL error	The DE bit is set when a transition is missed in the coding mode where a transition occurs for each bit.
	Frame length violation	A frame longer than the maximum value defined for this channel was detected.
	Non-octet frame	A frame whose bit length is not a multiple of 8 was received.
	Abort sequence	At least seven consecutive 1s were received during frame reception.
	CRC error	A frame contains a CRC error.
	Overrun	A receiver overrun occurred during frame reception.
	Reception timeout error	A frame that exceeds the specified limit was transmitted or received.

- Frame information
This stores the frame information.

13.2.2.2 J.NET module troubleshooting

If the ERR LED of the J.NET module is on, follow the instructions in Table 13-6 to troubleshoot the problem. If the ERR LED is off, troubleshoot the problem according to the following instructions.

(1) Troubleshooting from the transmission LED (TX) and the reception LED (RX)

Check whether the transmission LED (TX) and reception LED (RX) of the J.NET module are on or off, and then follow the instructions in Table 13-16 to troubleshoot the problem.

Table 13-16 Troubleshooting from the transmission LED (TX) and the reception LED (RX)

LED status	Check	Corrective action
Both the TX and RX LEDs are off.	Is the system information or NET information set up correctly?	Set up the information correctly.
	Have the MODU No. switch and BIT RATE switch been set correctly?	Correct the settings.
	Is the RI/O STOP input of the RI/O-IF module turned on?	Turn off the RI/O STOP input.
The TX LED is blinking, and the RX LED is off.	Are the cables connected correctly?	Connect the cables correctly.
	Is the termination resistor connected correctly?	Connect the termination resistor correctly.
	Is the slave device power turned on?	Turn on the slave device power.
	Are the NET information settings appropriate for the slave device?	Set up the NET information settings according to the slave device specifications.
Both the TX and RX LEDs are blinking.	Are the cables connected correctly?	Connect the cables correctly.
	Is the termination resistor connected correctly?	Connect the termination resistor correctly.
	Are the NET information settings appropriate for the slave device?	Set up the NET information settings according to the slave device specifications.

13. Troubleshooting

(2) Troubleshooting from sent and received data

Table 13-17 Troubleshooting from sent and received data

Sent and received data	Check	Corrective action
DO output is cleared.	Is the refresh cycle (monitoring time) setting value too small?	As the refresh cycle (monitoring time) (J.NET SYSTEM/S10VE [Edit NET1 (NET2) information] – Select an ID – [Edit]), in the [Edit system information] window, specify a value at least five times the NET1 (NET2) refresh cycle. Alternatively, specify "0" for the refresh cycle (monitoring time).
Transmission and reception data is not updated.	Are the transfer areas correctly set up in the NET information?	Set up the transfer areas correctly.
Communication times out.	Are there any sources of noise, such as an AC power cable, near the communication cables?	Separate the communication cables from noise sources.

(3) Error freeze

When a J.NET module detects a hardware error, the ERR LED turns on, and error freeze information is saved. The J.NET module then stops operating.

Figure 13-13 shows the format of the error freeze information. For information about error codes and the stack frame in the following format, see the following pages.

Main module Sub module

		2 ³¹ — 2 ¹⁶	2 ¹⁵ — 2 ⁰	No.	Error code	Description
/A40400	/AC0400	Error code	—	1	/0010	Bus error
/A40404	/AC0404	Time after recovery from reset (in ms)		2	/0011	Address error
		—		3	/0012	Invalid instruction
		—		4	/0013	Division by zero
/A40410	/AC0410	D0 register		5	/0014	Privilege violation
/A40414	/AC0414	D1 register		6	/0015	WDT error
/A40418	/AC0418	D2 register		7	/0016	Format error
/A4041C	/AC041C	D3 register		8	/0017	Spurious interrupt
/A40420	/AC0420	D4 register		9	/0018	Unused exception (for example, CHK, TRAPV, or L1010)
/A40424	/AC0424	D5 register		10	/0019	Parity error
/A40428	/AC0428	D6 register		11	/001A	Power shutdown notice
/A4042C	/AC042C	D7 register		12	/0100	Module No. setting switch setting error
/A40430	/AC0430	A0 register		13	/0101	BIT RATE setting switch setting error
/A40434	/AC0434	A1 register		14	/0102	ROM1 sum error
/A40438	/AC0438	A2 register		15	/0103	RAM1 compare error
/A4043C	/AC043C	A3 register		16	/0105	RAM2 compare error
/A40440	/AC0440	A4 register		17	/0107	DMA transfer error (NET1 transmission)
/A40444	/AC0444	A5 register		18	/0108	DMA transfer error (NET2 transmission)
/A40448	/AC0448	A6 register		19	/0109	DMA transfer error (NET1 reception)
/A4044C	/AC044C	A7 register		20	/010A	DMA transfer error (NET2 reception)
/A40450	/AC0450	Stack frame (4 words, 6 words, bus error)		21	/010B	ROM3 sum error
				22	/010C	ROM erase error
				23	/010D	ROM write error (communication control program block)
				24	/010E	ROM erase error (parameter block)
				25	/010F	ROM write error (parameter block)
				26	/0110	Parameter rewrite count limit exceeded
				27	/0112	Parameter error
/A404FC	/AC04FC					

Note 1: For details about the stack frame, see the next page.

Note 2: The above freezing error information is stored in /C40400 and up for the sub 2 module, and in /CC0400 and up for the sub 3 module.

Figure 13-13 Error freeze information

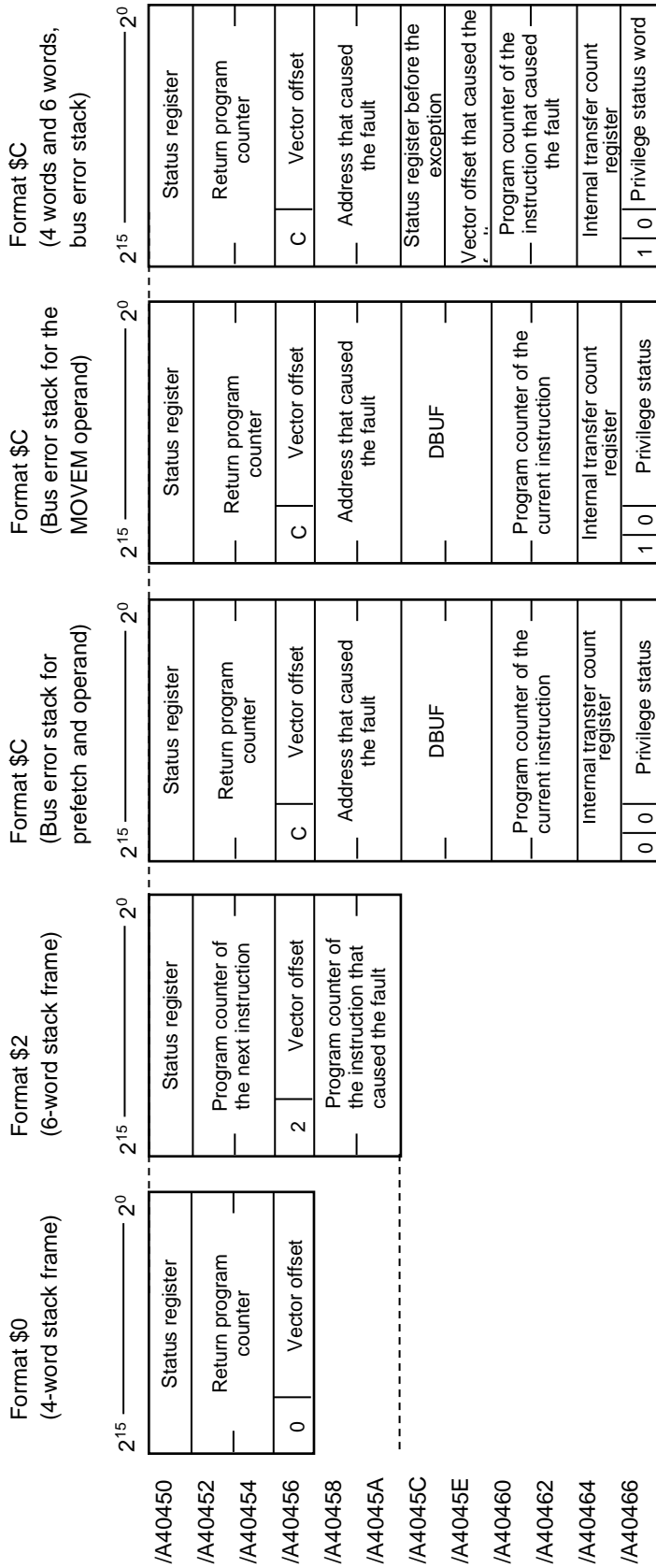

Figure 13-14 Address map of the stack frame

(4) Communication errors

(a) BASE SYSTEM/S10VE error log

When an error is detected in the J.NET module, information is recorded in the error log. You can check the error log from BASE SYSTEM/S10VE. For the procedure for checking the error log, see 8.4.6 *RAS functions*. If information is recorded in the error log, follow the instructions in Table 13-18 to perform recovery operations.

Table 13-18 J.NET module troubleshooting

Contents of the BASE SYSTEM/S10VE error log		Description	Recovery operation
Error code	Error message		
EC=50032010	I/O error (J.NET CRC error)	J.NET CRC error	- Check the network line connection and the termination resistor connection. - Verify that the SVPT settings match the station settings.
EC=50032020	I/O error (J.NET Station No. error)	J.NET station number error	
EC=50032030	I/O error (J.NET Undefined service operated)	J.NET undefined service instruction	
EC=50032040	I/O error (J.NET I / UI-frame length error)	J.NET I-frame length/UI-frame length error	
EC=50032041	I/O error (J.NET I-frame format error(non Exist))	J.NET I response error (I-frames not included)	
EC=50032042	I/O error (J.NET I-frame format error(Exist))	J.NET supervisory frame error (I-frames included)	
EC=50032050	I/O error (J.NET Data link sequence error)	J.NET data link sequence error	- Turn off and then turn on the power to the slave device. - Verify that the switch settings of the J.NET module and the slave device are correct.
EC=50032060	I/O error (J.NET Slave response Timeout error)	J.NET timeout generated (no response from the slave)	
EC=50032061	I/O error (J.NET recover not successful)	J.NET recovery after retry failed	- Check the network line connection and the termination resistor connection. - Verify that the SVPT settings match the station settings.
EC=50032070	I/O error (J.NET Transmit/Receive error)	J.NET line frame transmission/reception error	
EC=50032080	I/O error (J.NET error occurred (.etc))	J.NET error generated (miscellaneous error)	If the error occurs repeatedly, replace the J.NET module.
EC=50037061	I/O error (J.NET Waiting Input data)	J.NET input data pending	This is not an error.
EC=50037110	I/O error (J.NET Undefined service operated)	J.NET undefined service instruction	If the error occurs repeatedly, replace the J.NET module.
EC=50037120	I/O error (J.NET Transmission data length error)	J.NET data length error	
EC=50037130	I/O error (J.NET Transmission packet error)	J.NET packet structure error	
EC=50038020	I/O error (J.NET Initialize refused)	J.NET SVPT error (initialization command refused)	Reconfigure SVPT to match the slave device. If the error occurs repeatedly even after doing so, replace the slave device.
EC=50038081	I/O error (J.NET SVPT TX Bytes unmatched(Auto mode))	J.NET SVPT error (mismatch in transfer byte count in AUTO mode)	
EC=50038082	I/O error (J.NET SVPT TX Bytes unmatched(Slot))	J.NET SVPT error (mismatch in transfer byte count when the slot is specified)	
EC=50039001	I/O error (J.NET Station stopped)	J.NET station stopped	Turn off and then turn on the power to the slave device, and then reset the CPU. If the error occurs repeatedly even after doing so, replace the slave device.
EC=50039002	I/O error (J.NET Station error status detected)	J.NET station error	
EC=50039003	I/O error (J.NET St.err status detected and Stopped)	J.NET station error detected and stopped	
EC=5003A020	I/O error (J.NET PUT/GET (Insufficient address data))	J.NET PUT/GET error (insufficient address data)	Check and correct the PUT/GET service request from the slave device.
EC=5003A021	I/O error (J.NET PUT/GET(addr field number illegal))	J.NET PUT/GET error (address field number error)	
EC=5003A022	I/O error (J.NET PUT/GET(addr field format error))	J.NET PUT/GET error (numerical address field)	
EC=5003A040	I/O error (J.NET PUT/GET(Slot setting))	J.NET PUT/GET error (odd address)	

13. Troubleshooting

(b) Return code errors

When a J.NET module detects an error on the communications line, the module sets the ALM of the S register and the error flag of the NET status to ON. The module then writes an error code in the S table to record the error information.

Table 13-19 Error codes for communication errors

Error code	Description	Corrective action
7110	An undefined service was requested.	<ul style="list-style-type: none"> - Reset the CPU. If the error occurs after the reset, restart the system. - If the error persists, replace the J.NET module.
7120	The data length is incorrect.	
7130	The packet structure is incorrect.	
7061	Input data has not been completely acquired by the station.	<ul style="list-style-type: none"> - This is not an error. - The module returns to normal as soon as the input data is completely acquired.
2010	An error occurs during a CRC check.	<ul style="list-style-type: none"> - Verify that the network status is normal. - Verify that the SVPT settings match the station settings. - If the error persists, replace the J.NET module.
2020	The station number is between 128 and 254. The station number of the receiver is incorrect.	
2030	An undefined service was specified.	
2040	I frame length is 137 bytes or longer, and UI frame length is 134 bytes or longer.	
2041	An I frame is not included in the I response.	
2042	An I frame is included in the monitoring frame.	
2050	There is an error in the data link procedure.	
2060	A timeout occurred (no response was received from the slave device within the specified time).	
2061	Recovery was not possible after retries.	<ul style="list-style-type: none"> - Turn off and then turn on the power to the station. - Verify that the switch settings of the J.NET module and the station are correct. - If the error persists, replace the station.
2070	A frame could not be transmitted to the network. Alternatively, an error was detected while a frame was being received.	<ul style="list-style-type: none"> - Check the network line connection and the termination resistor connection. - Verify that the SVPT settings match the station settings. - Reset the CPU. If the error occurs after the reset, restart the system. - If the error persists, replace the J.NET module.
2080	A miscellaneous error occurred.	<ul style="list-style-type: none"> - Reset the CPU. If the error occurs after the reset, restart the system. - If the error persists, replace the J.NET module.

(c) Result and status errors

When a station connected to a J.NET module detects an error, the module sets the ALM of the S register and the error flag of the NET status to ON. The module then writes an error code in the S table to record the error information.

Table 13-20 Error codes for errors detected by a station

Error code	Description	Corrective action
9001	The station is currently stopped.	Turn off and then turn on the power to the station, and then reset the CPU. If the error persists, replace the station.
9002	A station error occurred. (An error occurred in the station.)	
9003	The station is currently stopped, and a station error has occurred.	
8020	An initialization request was rejected.	The SVPT settings are not consistent with the station. Reconfigure the SVPT to match the station. If the error persists, replace the station.
8081	In the AUTO mode, the registered transfer byte count is not consistent with the response I/O size from the station.	
8082	When the slot is specified, the registered transfer byte count is not consistent with the response I/O size from the station.	

(d) Polling errors

When a station connected to a J.NET module can perform polling and the module detects an error in a PUT/GET service request from the station, the module sets the ALM of the S register and the error flag of the NET status to ON. The module then writes an error code in the S table to record the error information.

Table 13-21 Polling error codes

Error code	Description	Corrective action
A020	Address data is insufficient. No corresponding symbol exists.	Check and correct the PUT/GET service request from the station.
A022	The address field is a numerical value.	
A021	An address field count error occurred.	
A040	The address is an odd number.	

13. Troubleshooting

(5) Error accumulation counters

Error accumulation counters count the number of communication errors between a J.NET module (master station) and a station (slave station). Error accumulation counters are initialized when the system is reset. (The following data is stored in /AC2*** for the sub module, /C42*** for the sub 2 module, and /CC2*** for the sub 3 module.)

[N1]	[N2]		2 ⁷ _____ 2 ⁰	
/A42000	/A42400	(For simultaneous	+00	Transmitter underrun (TXUN)
/A42020	/A42420	Station ID: 01	02	Missing CTS (TXCT)
/A42040	/A42440	Station ID: 02	04	Frame length violation (RXLG)
/A42060	/A42460	Station ID: 03	06	Non-octet array frame (RXNO)
/A42080	/A42480	Station ID: 04	08	Abort sequence (RSAB)
/A420A0	/A424A0	Station ID: 05	0A	CRC error (RXCR)
/A420C0	/A424C0	Station ID: 06	0C	Overrun (RXOV)
/A420E0	/A424E0	Station ID: 07	0E	Missing CD (RXCD)
/A42100	/A42500	Station ID: 08	10	Timeout (RXTO)
/A42120	/A42520	Station ID: 09	12	Reserved
/A42140	/A42540	Station ID: 0A	+1E	(14 bytes)
/A42160	/A42560	Station ID: 0B		
/A42180	/A42580	Station ID: 0C		
/A421A0	/A425A0	Station ID: 0D		
/A421C0	/A425C0	Station ID: 0E		
/A421E0	/A425E0	Station ID: 0F		
/A42200	/A42600	Station ID: 10		
/A42220	/A42620	Station ID: 11		
/A42240	/A42640	Station ID: 12		
/A42260	/A42660	Station ID: 13		
/A42280	/A42680	Station ID: 14		
/A422A0	/A426A0	Station ID: 15		
/A422C0	/A426C0	Station ID: 16		
/A422E0	/A426E0	Station ID: 17		
/A42300	/A42700	Station ID: 18		
/A42320	/A42720	Station ID: 19		
/A42340	/A42740	Station ID: 1A		
/A42360	/A42760	Station ID: 1B		
/A42380	/A42780	Station ID: 1C		
/A423A0	/A427A0	Station ID: 1D		
/A423C0	/A427C0	Station ID: 1E		
/A423E0	/A427E0	Station ID: 1F		

Figure 13-15 Address of the error accumulation counters

(6) Trace

A J.NET module traces the communication status for each network (N1 and N2) independently. Tracing starts in the error stop mode (that is, tracing stops when an error occurs) after a CPU reset or power restoration and records transmission and reception for each service individually.

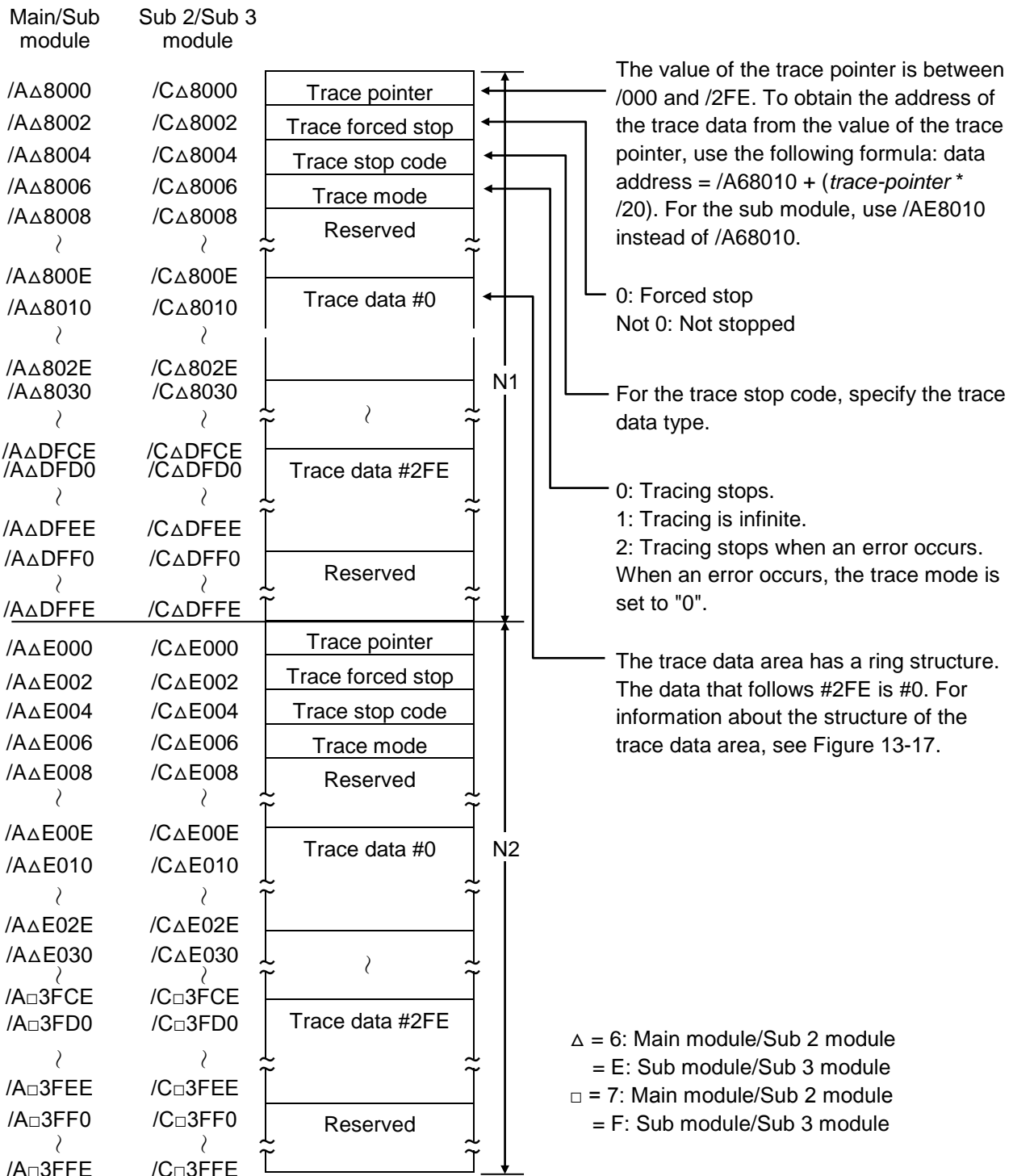

Figure 13-16 Structure of the trace area

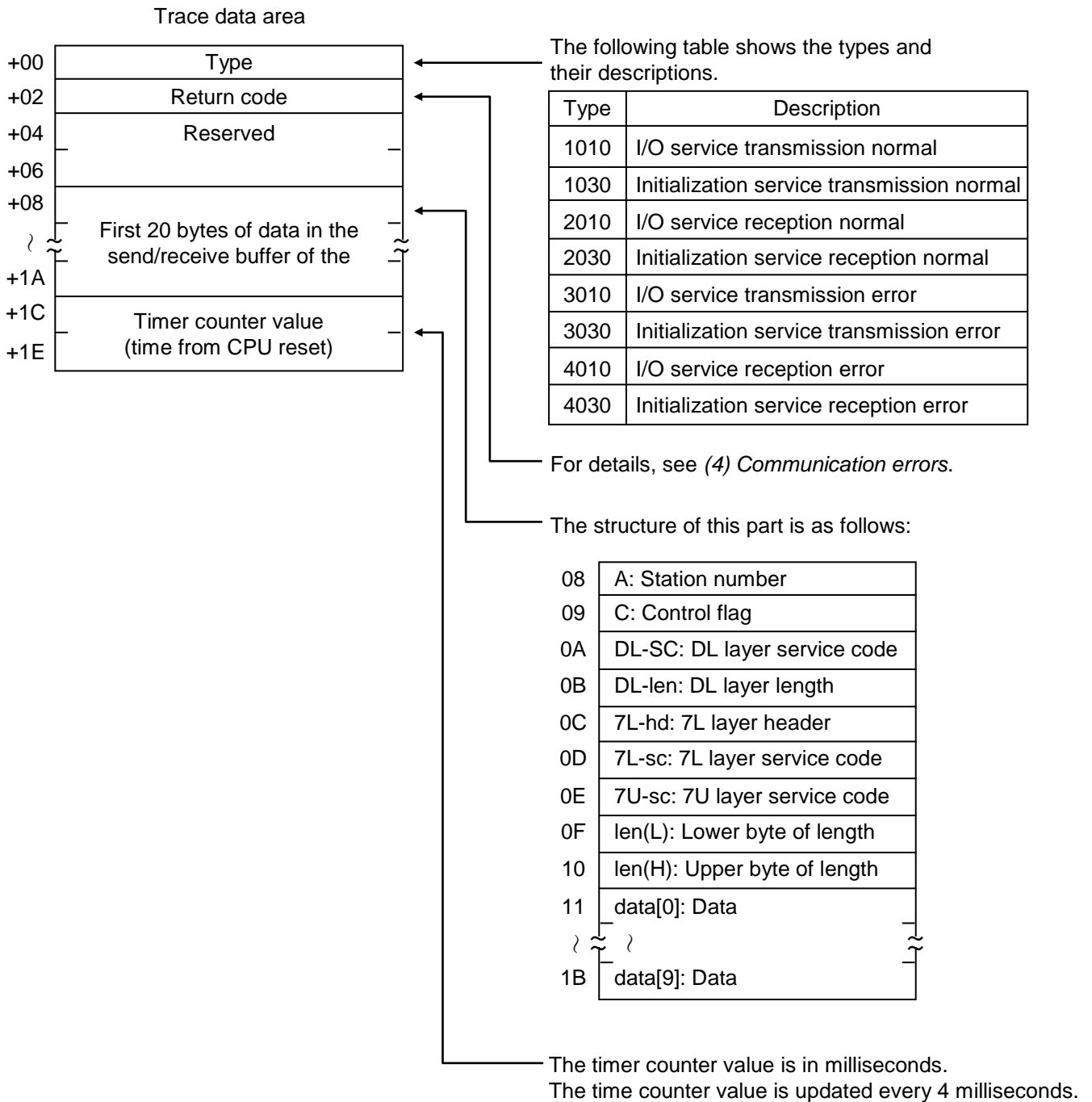

Figure 13-17 Structure of the trace data area

13.2.2.3 D.NET module troubleshooting

Check whether the MS LED and NS LED of the D.NET module are on or off, and then follow the instructions in Table 13-22 to troubleshoot the problem.

(1) Troubleshooting from the MS LED and NS LED

Table 13-22 Troubleshooting from the LED status

MS LED	NS LED	Description	Corrective action
OFF	OFF	Power off	--
ON (green)	OFF	<ul style="list-style-type: none"> • Objects are currently being initialized. • Duplicate MAC IDs are currently being checked. 	The D.NET module is in this state if communication is not possible after the module starts. See <i>Table 13-23 Causes of D.NET module communication failures</i> , and then take corrective action.
ON (green)	B (green)	<ul style="list-style-type: none"> • Configuration information is currently being received. • Objects are currently being constructed. 	If the bus goes off and recovers repeatedly during communication, the MS and NS LEDs (green) might appear to be blinking. The D.NET module is in this state if no communication destinations are registered.
ON (green)	B (red)	A connection timed out.	The D.NET module is in this state if an error occurs during communication with a slave device.
ON (green)	ON (green)	Communication is in progress. (A minor failure might have occurred.)	In the master mode, the D.NET module is in this state if the communication destination (slave device) is not connected or is turned off. In the slave mode, the D.NET module is in this state if communication is inactive (when the slave device is turned on first and is waiting for the master device to start communication).
ON (green)	B (red)	The bus is currently off.	The LED flash cycle is 0.5 seconds. Depending on how soon the module recovers from the bus going off, you might not notice the LED blinking even when the bus goes off.
	ON (red)	The module does not recover from the bus going off for at least 10 seconds (for one channel only).	
ON (red)	ON (red)	The module does not recover from the bus going off for at least 10 seconds (for both channels).	
ON (green)	ON (red)	A duplicate MAC ID was detected.	Check the S table to check the details of the duplicate MAC ID and the major failure.
ON (red)	OFF	A major failure occurred.	
		The Module No. setting switch is incorrectly set.	Set the Module No. setting switch correctly according to <i>2.1 Names and functions of each part</i> in the <i>SIOVE User's Manual Option D.NET (LQE770-E)</i> (manual number SEE-1-103).

ON: On, OFF: Off, B: Blinking

13. Troubleshooting

(2) Troubleshooting from the cabling and the communication settings

The following describes the causes of D.NET module communication failures. Take corrective action according to the relevant causes.

Table 13-23 Causes of D.NET module communication failures

No.	Cause of communication failure	Corrective action
1	Only one D.NET module exists in the network. (If no other nodes exist, communication is not possible.)	This is not an error. Connect other nodes to the network, and turn on the power to the nodes. Communication will then start normally.
2	Multiple nodes exist in the network, but transfer speed is inconsistent among the nodes.	Use the same transfer speed setting for all nodes in the network.
3	Multiple nodes exist in the network, but the network load is extremely high, and transmissions over the network are not possible. (This situation might occur when the MAC ID priority of the local node is lower than that of the other nodes. Smaller MAC IDs have higher priority.)	Reduce the network load, such as by choosing a longer transmission cycle for each node or reducing the number of nodes.
4	Network power is not being supplied. The LQE770-E does not require a power supply, but third-party DeviceNet products require it.	Connect network power to the devices that require it.
5	Network power is being supplied, but is of insufficient capacity.	Reconsider the network power capacity by referring to <i>3.3.5 Communication power supply location considerations</i> in the <i>S10VE User's Manual Option D.NET (LQE770-E)</i> (manual number SEE-1-103).
6	The cable length exceeds the maximum limit.	Reconsider the cable length by referring to <i>3.3.4 Restriction on the cable length</i> in the <i>S10VE User's Manual Option D.NET (LQE770-E)</i> (manual number SEE-1-103).
7	A termination resistor is not connected.	Connect a termination resistor according to <i>3.3.3 Components (4) Terminating resistor</i> in the <i>S10VE User's Manual Option D.NET (LQE770-E)</i> (manual number SEE-1-103).
8	A connection to the D.NET module is loose.	Verify that the connectors are securely inserted.
9	The CAN-H or CAN-L cable is loose.	Verify that the cables are securely connected.
10	The bit inversion mode is not selected when the module is connected to a third-party slave device.	Select the bit inversion mode when the module is connected to a third-party DI/O slave device.

(3) BASE SYSTEM/S10VE error log

When an error is detected in the D.NET module, information is recorded in the error log. You can check the error log from BASE SYSTEM/S10VE. For the procedure for checking the error log, see 8.4.6 *RAS functions*. If information is recorded in the error log, follow the instructions in Table 13-24 to perform recovery operations.

Table 13-24 D.NET module troubleshooting

D.NET display		CPU display			Contents of the BASE SYSTEM/S10VE error log		Description	Recovery operation
MS LED	NS LED	ERR LED	ALARM LED	Indicator display	Error code	Error message		
--	--	--	--	--	EC=50047082	I/O error (D.NET Recover from Transmission Bus Off)	D.NET recovery from bus off	This is simply a notification message stating that the system recovered from the bus going off, and does not indicate an error. No recovery operation is required.
Red	Red	--	--	--	EC=50047381	I/O error (D.NET Transmission Bus Off)	D.NET transmission line bus off	Check for loose connectors, and check the cabling, transmission speed, MAC ID, and MODU No. settings.
Red	Red	--	--	--	EC=50048181	I/O error (D.NET CAN Transmission Timeout Error.)	D.NET CAN transmission timeout error	

13. Troubleshooting

13.2.2.4 FL.NET module troubleshooting

If the ERR LED or LER LED of the FL.NET module is on, follow the instructions in Table 13-5 to troubleshoot the problem. If the ERR LED or LER LED is off, troubleshoot the problem according to the following instructions.

(1) BASE SYSTEM/S10VE error log

When an error is detected in the FL.NET module, information is recorded in the error log. You can check the error log from BASE SYSTEM/S10VE. For the procedure for checking the error log, see 8.4.6 *RAS functions*. If information is recorded in the error log, follow the instructions in Table 13-25 to perform recovery operations.

Table 13-25 FL.NET module troubleshooting

Contents of the BASE SYSTEM/S10VE error log		Description	Recovery operation
Error code	Error message		
EC=50027310	I/O error (FL.NET I/O CARRIER LOSS)	FL.NET carrier loss error	Check and correct the FL.NET line connection.
EC=50027311	I/O error (FL.NET I/O RETRY)	FL.NET retry error	
EC=50027312	I/O error (FL.NET I/O LATE)	FL.NET late collision error	
EC=50027351	I/O error (FL.NET I/O TX_ABORT)	FL.NET transmission aborted	
EC=50027353	I/O error (FL.NET I/O TX_DEFER)	FL.NET transmission error due to transmission delay	
EC=50027375	I/O error (FL.NET I/O RX_STAT_OVER)	FL.NET reception status FIFO overrun	Check and correct the network load.
EC=50027376	I/O error (FL.NET I/O TX_DATA_UNDER)	FL.NET reception data FIFO underrun	
EC=50027377	I/O error (FL.NET I/O RX_DATA_OVER)	FL.NET reception data FIFO overrun	
EC=50027508	I/O error (FL.NET I/O BUF_OVF)	FL.NET overflow of transmission/reception buffer managed by OS	
EC=5002750F	I/O error (FL.NET I/O SOCKET_OVF)	FL.NET socket table overflow	

(2) Network troubleshooting

(a) Network failures and corrective actions (when communication is unstable)

Table 13-26 Network failures and corrective actions (when communication is unstable)

Symptom	Check location	Check	Corrective action
Communication is not possible or is unstable.	Check the transmission line.	Does each station respond to the ping command appropriately?	Check the power supply, cables, and other items for the stations that do not respond to the ping command.
		Does the collision indicator turn on frequently?	Check the cable and connector contacts. Use an analyzer to check the details of the error.
		Is the repeater powered on?	Check the power supply, whether the power cable is disconnected, and the power voltage.
	Check the settings of the communicating stations.	Is the IP address of the network specified correctly?	Use the support tool or analyzer to double-check the selected IP address.
		Has the number of the station been specified correctly?	Use the support tool or analyzer to double-check the selected station number.
		Have the parameters of the station been specified correctly?	Use the support tool to double-check the parameters of the station that have been specified.
		Does the CD (carrier wave detection) indicator turn on continuously or intermittently?	Double-check the communication cable, hub power supply, and similar items.
Does the COM indicator turn on continuously or intermittently?	Double-check the settings of the station.		

13. Troubleshooting

(b) Checking the IP address by using the ping function on a PC

Without a dedicated tool such as an FL-net network analyzer, you can use, for example, a general-purpose PC to check the connection status and the IP address setting of an FL-net device. The following shows how to check the IP address by using the ping function.

Use the ping command to check whether there are any problems with the connection.

[1] Select **Start, All Programs, Accessories**, and then **Command Prompt**. The Command Prompt opens.

[2] Enter the ping command to run a basic communication test between the link unit and the PC. To use the ping command, enter `ping IP-address` or `ping host-name`.

Example of using an IP address: `ping 192.168.250.13`

If the applicable FL-net device was set up properly, the following message is displayed:

```
Pinging 192.168.250. 13 with 32 bytes of data
Reply from 192.168.250. 13: bytes=32 time=2ms TTL=32
Reply from 192.168.250. 13: bytes=32 time=1ms TTL=32
Reply from 192.168.250. 13: bytes=32 time=1ms TTL=32
Reply from JEMA 192.168.250. 13 : bytes=32 time=1ms TTL=32
C:¥WINDOWS>
```

[3] If the device is not connected, the following message (timeout) is displayed:

```
Pinging 192.168.250. 13 with 32 bytes of data:
Request timed out.
Request timed out.
Request timed out.
Request timed out.
C:¥WINDOWS>
```

(3) Notes on using FL-net

For details about the specifications of the FL-net transmission line, see the *SIOVE User's Manual Option FL.NET (LQE702-E)* (manual number SEE-1-104) or see IEEE 802.3. The following is a list of notes on using the FL-net:

- Make sure that no communications data from other Ethernet connections is transmitted over an FL-net communication cable.
- Do not connect an FL-net to a router.
- Using a switching hub for an FL-net is not effective.
- If you use media such as infrared or wireless communications, the real-time responsiveness of communication might deteriorate considerably.
- When using a PC, the real-time responsiveness of communication might change considerably depending on the performance level of the PC and the OS and applications being used.
- Use fixed IP addresses. The same network address must be used. (The standard network address is 192.168.250.) There is a recommended input range for the node number (station number) of the IP address. Duplication of node numbers cannot be checked at initialization, and a node number duplication error is reported only after communication starts. Use caution when setting the node numbers.

Network address	Node number
192.168.250.	1 to 249

- Securely connect the ground cable. In addition, use a ground cable with a thickness of at least 2 mm².
- Maintain a sufficient distance between communication cables and noise sources. For example, do not run a power cable alongside a communications cable.
- When cyclic data and message data are sent at the same time, the real-time responsiveness of communications might deteriorate.
- You do not have to allocate consecutive areas (common memory areas) for cyclic data communication.
- Overall on-time data communicability of the system is affected by the processing performance of connected devices. Communication speeds are only as fast as the slowest device (with the largest value for the minimum allowable frame interval). As a result, connecting or adding a single device may considerably reduce the real-time responsiveness of the overall system.
- The header block of message data communications uses big-endian, whereas the data block uses little-endian. As an exception, the system parameter of the data block for profile reading uses big-endian (meaning that MSB is sent first).

13.2.2.5 ET.NET module troubleshooting

For information about troubleshooting cases where data is not output to communications devices from the ET.NET module, or where data is not input into the ET.NET module from communications devices, see Figure 13-18. If the CPU module indicator displays an error code, take corrective action according to Table 13-8.

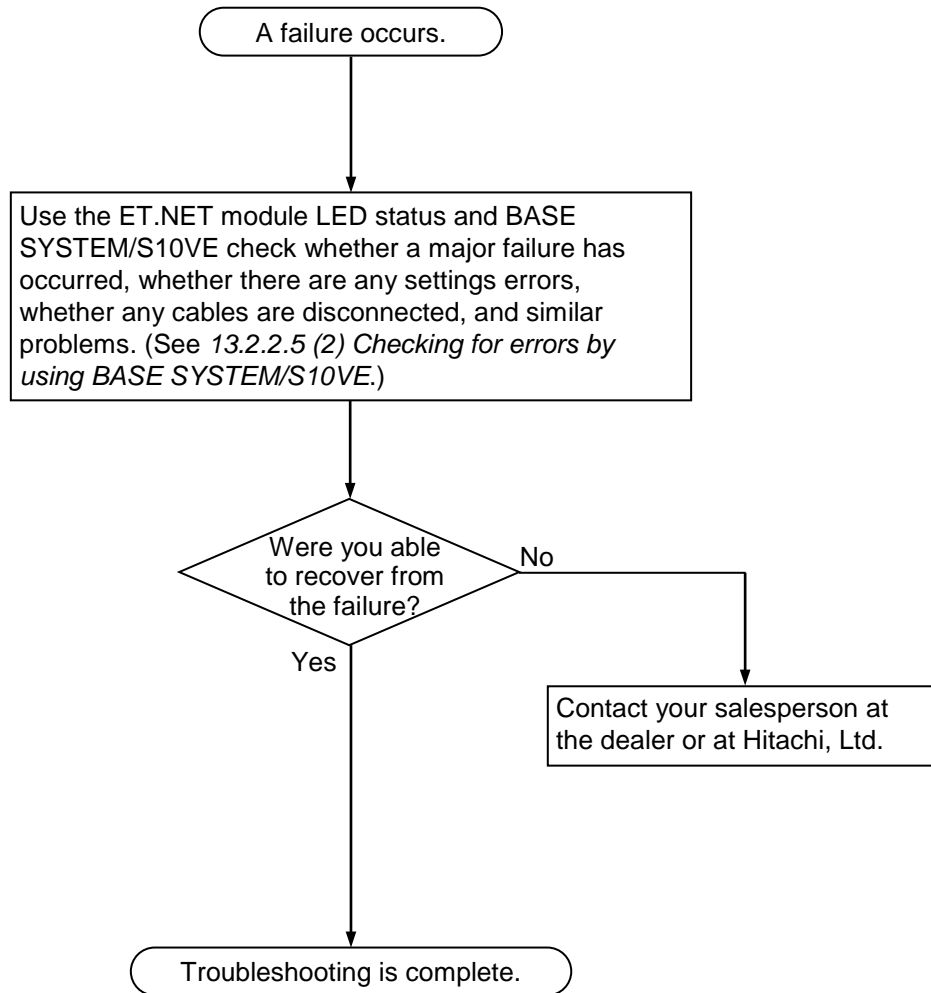

Figure 13-18 Troubleshooting procedure

- Failed parts in an example system configuration

In Figure 13-19, parts (1) through (6) indicate parts for which a failure might occur in a system configuration that uses an ET.NET module. Identification of failed parts proceeds from the ET.NET module. PADT is used to identify the part in which the failure occurred on the route from the ET.NET module to the communication devices. PADT connects to the S10VE CPU module.

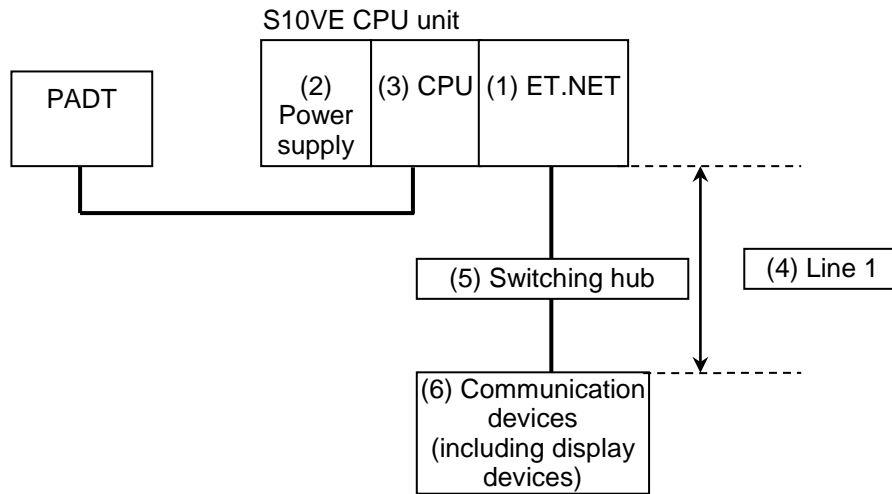

Figure 13-19 Failed parts in an example system configuration

13. Troubleshooting

(1) Checking the LED status of the ET.NET module

Check the LED status of the ET.NET module, use Table 13-27 to identify the part in which a failure occurred, and then take corrective action.

The parts labeled (1) through (6) that are assumed to contain failures correspond to (1) through (6) in Figure 13-19.

Table 13-27 Assumed failure causes and corrective action, from the LED status of the ET.NET module (1/3)

No.	LED status of the ET.NET module					Check description	Assumed failed part	Assumed failure cause	Corrective action
	RUN	ALARM	ERR	TX/RX	10M/100M				
1	OFF	OFF	OFF	OFF	OFF	The power module LED is off.	(2) Power module	The power switch of the power module is off, or the power module has failed.	Turn on the power switch of the power module. If the power switch is on and the LED of the power module is off, replace the power module.
						Other than the above	(1) ET.NET module	ET.NET module failure	Replace the ET.NET module.
2	OFF	OFF	OFF	OFF	--	Check whether the ERR LED of the CPU module is on.	(3) CPU module	The CPU module has stopped due to an error.	See Table 13-2, and eliminate the cause of the CPU module failure.
						Check whether the CPU RUN/STOP switch on the CPU module is in the STOP position.	(3) CPU module (in the STOP position)	The CPU RUN/STOP switch on the CPU module is in the STOP position.	Set the CPU RUN/STOP switch of the CPU module to the RUN position, and then start the ET.NET module.
3	B	OFF	OFF	OFF	OFF	The RUN LED is blinking, even after the CPU RUN/STOP switch on the CPU module is set to the RUN position.	(1) ET.NET module	ET.NET module failure	Replace the ET.NET module.
4	OFF	OFF	OFF	--	--	The power module LED is on.	(1) ET.NET module	ET.NET module failure	Replace the ET.NET module.
5	OFF	OFF	ON	OFF	--	Check the CPU module indicator display. For details, see Table 13-8.	(1) ET.NET module	ET.NET module failure	Replace the ET.NET module.

OFF: Off, ON: On, B: Blinking, --: On or off

Table 13-27 Assumed failure causes and corrective action, from the LED status of the ET.NET module (2/3)

No.	LED status of the ET.NET module					Check description	Assumed failed part	Assumed failure cause	Corrective action
	RUN	ALARM	ERR	TX/RX	10M/100M				
6	ON	ON	OFF	OFF	--	The CPU module indicator display shows error code 0E7D12 or 0E7D1A.	(1) ET.NET module	The setting of the MAIN/SUB setting switch is duplicated or incorrect.	Check and correct the value of the MAIN/SUB setting switch.
						The CPU module indicator display shows error code 0E7D1B.		The setting of the ST.No. setting switch is incorrect.	Check and correct the value of the ST.No. setting switch.
						The CPU module indicator display shows error code 0E7D1C.		Communication settings not specified	Specify the communication settings.
						The CPU module indicator display shows error code 0E7512.		An IP address is duplicated.	Check and correct the IP address and settings values of the connection-destination communication device to ensure that nothing is duplicated.
						The CPU module indicator display shows error code 0E7510.		Network driver initialization error	Check and correct the communication settings.
						The CPU module indicator display shows error code 0E7511.		A duplicate network address error occurred.	Check and correct the network settings.

OFF: Off, ON: On, B: Blinking, --: On or off

Table 13-27 Assumed failure causes and corrective action, from the LED status of the ET.NET module (3/3)

No.	LED status of the ET.NET module					Check description	Assumed failed part	Assumed failure cause	Corrective action
	RUN	ALARM	ERR	TX/RX	10M/100M				
7	ON	OFF	OFF	OFF	OFF	Check the power switch of the switching hub.	(5) Switching hub	The power switch of the switching hub is off.	Turn on the power switch of the switching hub.
								The switching hub has failed.	Replace the switching hub.
						Verify that the cables are connected correctly and that nothing is disconnected.	(4) Line 1	A cable connection problem exists at either the ET.NET end or the switching hub end.	Correct the connection at the ET.NET end or the switching hub end.
								A cable is disconnected.	Replace the cable.
					Other than the above	(1) ET.NET module	The Ethernet connector of the ET.NET module has failed.	Replace the ET.NET module.	
8	ON	OFF	OFF	B	ON	Check the operating status of the connection-destination communication device.	(6) Communication device	The settings of the connection-destination communication device are incorrect or the device has stopped due to an error.	Take corrective action with respect to the connection-destination communication device.
						The CPU module indicator display shows error code 0E7512.		The IP address of the connection-destination communication device is duplicated.	Check and correct the IP address and settings values of the connection-destination communication device to ensure that nothing is duplicated.

OFF: Off, ON: On, B: Blinking, --: On or off

(2) Checking for errors by using BASE SYSTEM/S10VE

You can check errors from BASE SYSTEM/S10VE. For the checking procedure, see *8.4.6 RAS functions*.

The following error information can be checked from BASE SYSTEM/S10VE:

- ET.NET module error logs (error codes and the dates and times when errors occurred)
- Ethernet communication trace logs of the ET.NET module
- DHP information of the ET.NET module
- ET.NET module network information

Sockets, interfaces, memory, routing information, protocols, count information, and various ARP information

13. Troubleshooting

(a) ET.NET module error codes and corrective action

When the ET.NET module detects an error, error information is saved in the CPU module or the ET.NET module. For details about checking the error information, see 8.4.6.2 *RAS menu: Error Log Display* and 8.4.6.3 *Displaying error log details*.

Table 13-28 shows the error codes that the ET.NET module reports to the CPU module, and Table 13-29 shows the internal ET.NET module error codes. Take corrective action according to Tables 13-28 and 13-29.

Table 13-28 Error codes reported to the CPU module from the ET.NET module (1/4)

No.	Error code	Error message	Description	ERR LED	ALARM LED	CPU module indicator display	Corrective action
1	0x500E7D13	Module error (ET.NET ETHERNET LSI CHECK ERROR)	ET.NET LANCE diagnosis error	ON	--	0E7D13	Replace the module.
2	0x500E7D14	Module error (ET.NET SDRAM CHECK ERROR)	ET.NET SDRAM initialization error	ON	--	0E7D14	Replace the module.
3	0x500E7D18	Module error (ET.NET ROM CHECKSUM ERROR)	ET.NET ROM checksum error	ON	--	0E7D18	Replace the module.
4	0x500E3031	Module error (ET.NET Inst. Alignment Error)	ET.NET instruction alignment error	ON	--	0E3031	Replace the module.
5	0x500E3041	Module error (ET.NET Illegal Instruction)	ET.NET illegal instruction error	ON	--	0E3041	Replace the module.
6	0x500E3081	Module error (ET.NET Privileged Instruction)	ET.NET privileged instruction error	ON	--	0E3081	Replace the module.
7	0x500E30F9	Module error (ET.NET Illegal Exception)	ET.NET illegal exception error	ON	--	0E30F9	Replace the module.
8	0x500E3389	Module error (ET.NET FP Unavailable)	ET.NET floating-point unavailable exception	ON	--	0E3389	Replace the module.
9	0x500E3391	Module error (ET.NET FP Program Error)	ET.NET floating point operation error	ON	--	0E3391	Replace the module.
10	0x500E3401	Module error (ET.NET Instruction Page Fault)	ET.NET instruction access page fault	ON	--	0E3401	Replace the module.
11	0x500E3421	Module error (ET.NET Invalid Inst. Access)	ET.NET instruction access error	ON	--	0E3421	Replace the module.
12	0x500E3461	Module error (ET.NET Inst. Access Protection)	ET.NET instruction access protection error	ON	--	0E3461	Replace the module.
13	0x500E3471	Module error (ET.NET Data Alignment Error)	ET.NET data alignment error	ON	--	0E3471	Replace the module.
14	0x500E3601	Module error (ET.NET Data Page Fault)	ET.NET data access page fault	ON	--	0E3601	Replace the module.
15	0x500E3621	Module error (ET.NET Invalid Data Access)	ET.NET data access error	ON	--	0E3621	Replace the module.
16	0x500E3661	Module error (ET.NET Data Access Protection)	ET.NET data access protection error	ON	--	0E3661	Replace the module.

ON: On, --: Off

Table 13-28 Error codes reported to the CPU module from the ET.NET module (2/4)

No.	Error code	Error message	Description	ERR LED	ALARM LED	CPU module indicator display	Corrective action
17	0x500E3820	Module error (ET.NET Memory Error)	ET.NET memory error	ON	--	0E3820	Replace the module.
18	0x500E3B70	Module error (ET.NET Bus Target Abort)	ET.NET bus target abort	--	--	0E3B70	Identify the failed part, and then replace the module.
19	0x500E3B81	Module error (ET.NET System Bus Error CPU Master)	System bus error (access from ET.NET module)	ON	--	0E3B81	Replace the module.
20	0x500E3B82	Module error (ET.NET System Bus Error CPU Target)	System bus error (access to ET.NET module)	ON	--	0E3B82	Replace the module.
21	0x500E3B90	Module error (ET.NET PCI_BUS_ERR)	ET.NET PCI bus error	ON	--	0E3B90	Replace the module.
22	0x500E5001	Module error (ET.NET Undefined Invalid Interrupt)	ET.NET undefined invalid interrupt	ON	--	0E5001	Replace the module.
23	0x500E5002	Module error (ET.NET INTEVT Invalid Interrupt)	ET.NET INTEVT invalid interrupt	ON	--	0E5002	Replace the module.
24	0x500E50F1	Module error (ET.NET HERST Invalid Interrupt)	ET.NET serious fault invalid interrupt	ON	--	0E50F1	Replace the module.
25	0x500E50F2	Module error (ET.NET HERST2 Invalid Interrupt)	ET.NET serious fault invalid interrupt 2	ON	--	0E50F2	Replace the module.
26	0x500E50F3	Module error (ET.NET BUERRSTAT Invalid Interrupt)	ET.NET bus error serious fault invalid interrupt status	ON	--	0E50F3	Replace the module.
27	0x500E50F6	Module error (ET.NET NHPMCLG Invalid Interrupt)	ET.NET memory serious fault invalid interrupt status	ON	--	0E50F6	Replace the module.
28	0x500E50F7	Module error (ET.NET ECC 2bit Master Invalid Interrupt)	ET.NET memory ECC 2-bit error serious fault invalid interrupt status	ON	--	0E50F7	Replace the module.
29	0x500E50F8	Module error (ET.NET RERRMST Invalid Interrupt)	ET.NET RERR invalid interrupt status	ON	--	0E50F8	Replace the module.
30	0x500E5110	Module error (ET.NET Macro parameter error)	ET.NET macro parameter error	ON	--	0E5110	Replace the module.
31	0x500E5130	Module error (ET.NET Undefined Macro)	ET.NET undefined macro issued	ON	--	0E5130	Replace the module.
32	0x500E5700	Module error (ET.NET System Error)	ET.NET system down (system error)	ON	--	0E5700	Replace the module.
33	0x500E5800	Module error (ET.NET Kernel Trap)	ET.NET system down (kernel trap)	ON	--	0E5800	Replace the module.
34	0x500E5C70	Module error (ET.NET WDT timeout error)	ET.NET watchdog timeout	ON	--	0E5C70	Replace the module.

ON: On, --: Off

Table 13-28 Error codes reported to the CPU module from the ET.NET module (3/4)

No.	Error code	Error message	Description	ERR LED	ALARM LED	CPU module indicator display	Corrective action
35	0x500E7308	Module error (ET.NET SEND_TIMEOUT)	ET.NET transmission timeout error ^{#1, #3}	ON	--	0E7308	If recovery is not possible even after restoring power, replace the module.
36	0x500E730A	Module error (ET.NET RESET_ERROR)	ET.NET hard reset error ^{#3}	ON	--	0E730A	If recovery is not possible even after restoring power, replace the module.
37	0x500E7505	Module error (ET.NET INV_INTR)	ET.NET invalid interrupt generated from the line ^{#3}	ON	--	0E7505	Replace the module.
38	0x500E7510	I/O error (ET.NET IFCONFIG_UP)	ET.NET network driver initialization error ^{#3}	--	ON	0E7510	Check and correct the settings.
39	0x500E7511	I/O error (ET.NET NETADDR_DUPL)	ET.NET duplicate network address error (system setup setting error)	--	ON	0E7511	Check and correct the network settings.
40	0x500E7512	I/O error (ET.NET IPADDR_DUPL)	ET.NET duplicate IP address error (system setup setting error detected on startup) ^{#3}	--	ON	0E7512	Check and correct the IP address settings.
41			ET.NET duplicate IP address error (system setup setting error detected when online) ^{#3}	--	--	0E7512	Check and correct the IP address settings.
42	0x500E7D1C	I/O error (ET.NET Invalid network setting)	ET.NET communication setting undefined	--	ON	0E7D1C	Specify the communication settings.
43	0x500E7D01	Module error (ET.NET INVALID EXCEPTION)	ET.NET invalid exception generated	ON	--	0E7D01	Replace the module.
44	0x500E7D11	Module error (ET.NET Invalid MAC ADDRESS)	ET.NET MAC address error	ON	--	0E7D11	Replace the module.
45	0x500E7D12	I/O error (ET.NET Invalid MAIN/SUB switch setting Duplication)	ET.NET duplicate MAIN/SUB switch setting ^{#5, #6}	--	ON	0E7D12	Check and correct the setting of the MAIN/SUB setting switch.
46	0x500E7D1A	I/O error (ET.NET Invalid MAIN/SUB switch setting)	ET.NET MAIN/SUB switch setting error ^{#5}	--	ON	0E7D1A	Check and correct the setting of the MAIN/SUB setting switch.
47	0x500E7D1B	I/O error (ET.NET Invalid ST. No. switch setting)	ET.NET ST.no. switch setting error ^{#5}	--	ON	0E7D1B	Check and correct the setting of the ST.No. setting switch.
48	0x500ED010	Module error (ET.NET Memory Alarm)	ET.NET memory 1-bit error (solid)	ON	--	0ED010	Replace the module.
49	0x500ED810	Module error (ET.NET BPU Error)	ET.NET BPU error	ON	--	0ED810	Replace the module.

ON: On, --: Off

Table 13-28 Error codes reported to the CPU module from the ET.NET module (4/4)

No.	Error code	Error message	Description	ERR LED	ALARM LED	CPU module indicator display	Corrective action
50	Nothing displayed	--#2, #4	Carrier loss error	--	--	None	If the error persists, check and correct the transmission line.
51	Nothing displayed	--#4	Retry error	--	--	None	If the error persists, check and correct the transmission line.
52	Nothing displayed	--#4	Late collision error	--	--	None	If the error persists, check and correct the transmission line.
53	Nothing displayed	--#4	Transmission/reception buffer overflow	--	--	None	Check and correct the network load.
54	Nothing displayed	--#4	Socket table overflow	--	--	None	Check and correct the application program.

ON: On, --: Off

#1: This message is output once when the error is detected five times consecutively.

#2: If a cable becomes disconnected during TCP communication, the connection is lost. If the error persists, a carrier loss error occurs, and nothing is output to the error logs.

#3: The channel on which the error occurred can be determined from the error logs.

#4: Errors related to communication failures increment the count information, and are not included in the error report.

#5: The following are checked in the given order of priority, and if an error is detected, an error is reported and operation is stopped.

- (1) No. 46 MAIN/SUB setting switch setting error
- (2) No. 45 MAIN/SUB setting switch duplicate setting
- (3) No. 47 ST.No. setting switching setting error

#6: The ALARM LED turns on for all ET.NET modules for which the MAIN/SUB settings are duplicated, and the error is output to the error log of the module with the smallest installation slot number.

#7: When accessing the CPU module or another ET.NET module from an ET.NET module, information is recorded if the ET.NET module detects a bus error.

#8: When accessing an ET.NET module from the CPU module or another ET.NET module, information is recorded if the ET.NET module detects a bus error.

Table 13-29 Internal ET.NET module error codes (1/2)

No.	Error code	Error message	Description	ERR LED	ALARM LED	CPU module indicator display	Corrective action
1	0x03030000	Inst. Alignment Error	Instruction alignment error	ON	--	0E3031	Replace the module.
2	0x03040000	Illegal Instruction	Illegal instruction error	ON	--	0E3041	Replace the module.
3	0x03080000	Privileged Instruction	Privileged instruction error	ON	--	0E3081	Replace the module.
4	0x030F0000	Illegal Exception	Illegal exception error	ON	--	0E30F9	Replace the module.
5	0x03380000	FP Unavailable	Floating-point unavailable exception	ON	--	0E3389	Replace the module.
6	0x03390000	FP Program Error	Floating-point calculation error	ON	--	0E3391	Replace the module.
7	0x03400000	Instruction Page Fault	Instruction access page fault	ON	--	0E3401	Replace the module.
8	0x03420000	Invalid Inst. Access	Instruction access error	ON	--	0E3421	Replace the module.
9	0x03460000	Inst. Access Protection	Instruction access protect error	ON	--	0E3461	Replace the module.
10	0x03470000	Data Alignment Error	Data alignment error	ON	--	0E3471	Replace the module.
11	0x03600000	Data Page Fault	Data access page fault	ON	--	0E3601	Replace the module.
12	0x03620000	Invalid Data Access	Data access error	ON	--	0E3621	Replace the module.
13	0x03660000	Data Access Protection	Data access protect error	ON	--	0E3661	Replace the module.
14	0x03820000	Memory Error	Memory error	ON	--	0E3820	Replace the module.
15	0x03B70000	Master/ Target Abort	Bus target abort	--	--	0E3B70	Identify the failed part, and then replace the module.
16	0x03B80001	System Bus Error CPU Master	CPU master access system bus error ^{#2}	ON	--	0E3B81	Replace the module.
17	0x03B80002	System Bus Error CPU Target	CPU target access system bus error ^{#3}	ON	--	0E3B82	Replace the module.
18	0x03B90000	PCI_BUS_ERR	PCI bus error	ON	--	0E3B90	Replace the module.
19	0x05000001	Undefined Invalid Interrupt	Undefined invalid interrupt	ON	--	0E5001	Replace the module.
20	0x0500**** #4	Invalid Interrupt	Invalid interrupt other than No. 19 and Nos. 21 through 27	ON	--	0E5001	Replace the module.
21	0x05000002	INTEVT Invalid Interrupt	INTEVT invalid interrupt	ON	--	0E5002	Replace the module.
22	0x0500F001	HERST Invalid Interrupt	Serious fault invalid interrupt	ON	--	0E50F1	Replace the module.
23	0x0500F002	HERST Invalid Interrupt(2)	Serious fault invalid interrupt 2	ON	--	0E50F2	Replace the module.
24	0x0500F003	BUERRSTAT Invalid Interrupt	PCI bus error serious fault invalid interrupt status	ON	--	0E50F3	Replace the module.
25	0x0500F006	MHPMCLG Invalid Interrupt	Memory serious fault invalid interrupt status	ON	--	0E50F6	Replace the module.
26	0x0500F007	ECC 2bit Master Invalid Interrupt	Memory ECC 2 bit error serious fault invalid status	ON	--	0E50F7	Replace the module.
27	0x0500F008	RERRMST Invalid Interrupt	PERR invalid interrupt status	ON	--	0E50F8	Replace the module.
28	0x05110000	Macro parameter error	Macro parameter error	ON	--	0E5110	Replace the module.

ON: On, --: Off

Table 13-29 Internal ET.NET module error codes (2/2)

No.	Error code	Error message	Description	ERR LED	ALARM LED	CPU module indicator display	Corrective action
29	0x05130000	Invalid Macro	Issuing of undefined-macro	ON	--	0E5130	Replace the module.
30	0x05140000	ULSUB STOP	System down (built-in sub-stop)	ON	--	0E5700	Replace the module.
31	0x0570000* #5	System Error	System down (system error)	ON	--	0E5700	Replace the module.
32	0x05800000	Kernel Trap	System down (kernel trap)	ON	--	0E5800	Replace the module.
33	0x05C70000	WDT timeout error	WDT timeout	ON	--	0E5C70	Replace the module.
34	0x07801308	SEND_TIMEOUT	Transmission timeout error ^{#1, #6}	ON	--	0E7308	If recovery is not possible even after restoring power, replace the module.
35	0x0780130A	RESET_ERROR	Hardware reset error ^{#6}	ON	--	0E730A	If recovery is not possible even after restoring power, replace the module.
36	0x07801505	INV_INTR	Invalid interrupt generated ^{#6}	ON	--	0E7505	Replace the module.
37	0x07801510	IFCONFIG_UP	Network driver initialization error ^{#6}	--	ON	0E7510	Check and correct the settings.
38	0x07801511	NETADDR_DUPL	Duplicate network address error	--	ON	0E7511	Check and correct the network settings.
39	0x07801512	IPADDR_DUPL	Duplicate IP address error (system configuration setting error detected on startup) ^{#6}	--	ON	0E7512	Check and correct the IP address settings.
40			Duplicate IP address error (system configuration setting error detected when online) ^{#6}	--	--	0E7512	Check and correct the IP address settings.
41	0x07807D1C	Invalid network setting	Communication settings not yet set	--	ON	0E7D1C	Specify the communication settings.
42	0x0D010000	Memory Alarm	Memory 1-bit error (solid)	ON	--	0ED010	Replace the module.
43	0x0D810000	BPU Error	BPU error	ON	--	0ED810	Replace the module.

ON: On, --: Off

#1: This message is output once when the error is detected five times consecutively.

#2: When accessing the CPU module or another ET.NET module from an ET.NET module, information is recorded if the ET.NET module detects a bus error.

#3: When accessing an ET.NET module from the CPU module or another ET.NET module, information is recorded if the ET.NET module detects a bus error.

#4: No. 20 error codes are error codes other than for No. 19 and Nos. 19 through 27.

#5: The following values take the place of the asterisk (*):

*: 0 or 1

#6: The channel on which the error occurred can be determined from the error logs.

13. Troubleshooting

(b) Error log display

To display the error log information, select an option from the BASE SYSTEM/S10VE main menu.

To display the error log, click **RAS, Error Log Display**, and **Display Error log CP** to display the error log information window. Then, from the **Module Name** drop-down list, select either **ET.NET (MAIN)** or **ET.NET (SUB)** to check the ET.NET module error codes.

(c) Ethernet communication trace logs

You can view the Ethernet communication trace log from the ET.NET module error history. From the BASE SYSTEM/S10VE main menu, click **RAS** and **Ethernet Communication of Trace Log**, and then either **LADDER** or **Socket Handler** to view the Ethernet communication trace logs. The error trace log is classified into **LADDER** for the ladder and **Socket Handler** for the socket handler.

- Ethernet communication trace log (for ladder)

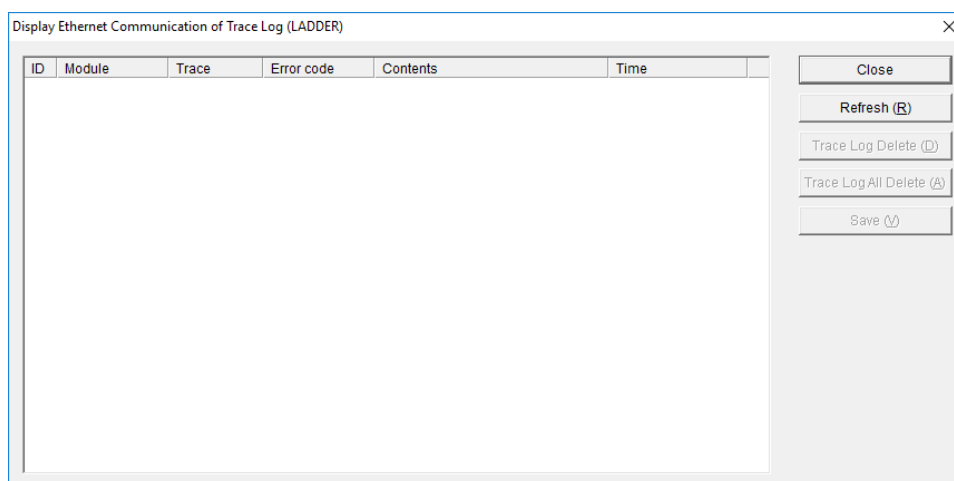

Display Ethernet Communication of Trace Log (LADDER) window

Function: This window displays the trace logs for errors that occur in ladder Ethernet communications.

Table 13-30 shows the details of the trace log.

Table 13-30 Ethernet communication trace log information (for ladder)

No.	Item	Displayed information
1	ID	The management table number for ladder Ethernet communication.
2	Module	The module name.
3	Trace	The trace code of the trace information.
4	Error code	The error code of the error.
5	Contents	The contents of the error code of the error
6	Time	The time when the error occurred.

13. Troubleshooting

- Ethernet communication trace log (for socket handler)

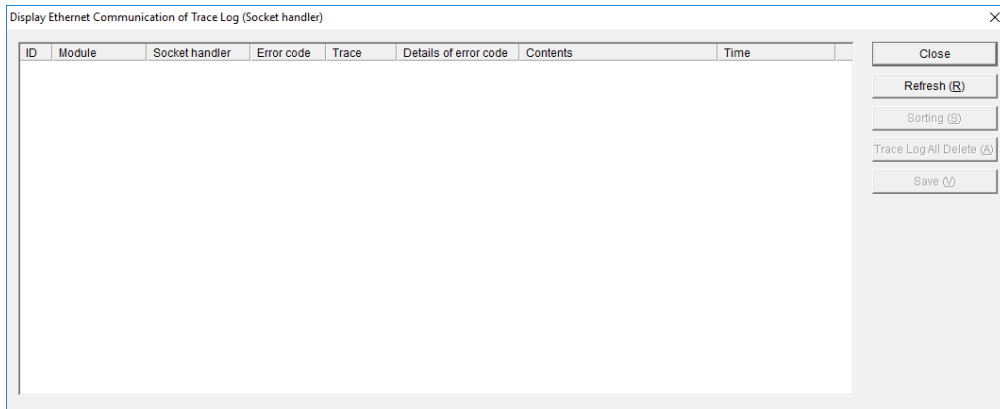

Display Ethernet Communication of Trace Log (Socket Handler) window

Function: This window displays the trace logs for errors that occur in socket handler Ethernet communications.

Table 13-31 shows the details of the trace log.

Table 13-31 Ethernet communication trace log information (for socket handler)

No.	Item	Displayed information
1	ID	The socket ID of the socket handler.
2	Module	The module name.
3	Socket handler	The name of the socket handler.
4	Error code	The error code of the error.
5	Trace	The location where the error was detected.
6	Details of error code	The detailed error code output when the error was detected.
7	Contents	The contents of the error code of the error.
8	Time	The time when the error occurred.

For details about traces, see *Appendix F. List of DHP Codes* in the *SIOVE Software Manual CPMS General Description and Macro Specifications* (manual number SEE-3-201).

For detailed error codes and descriptions, see *1.6 ET.NET socket handler* in *PART 2* in the *SIOVE Software Manual CPMS General Description and Macro Specifications* (manual number SEE-3-201).

d) DHP information

You can view DHP information from the ET.NET module operation history. From the BASE SYSTEM/S10VE main menu, click **RAS** and then **DHP Information** to view the DHP information. For **Module Name**, the names **ET.NET (Main)** and **ET.NET (Sub)** are displayed. From the **Module Name** drop-down list, select the applicable ET.NET module.

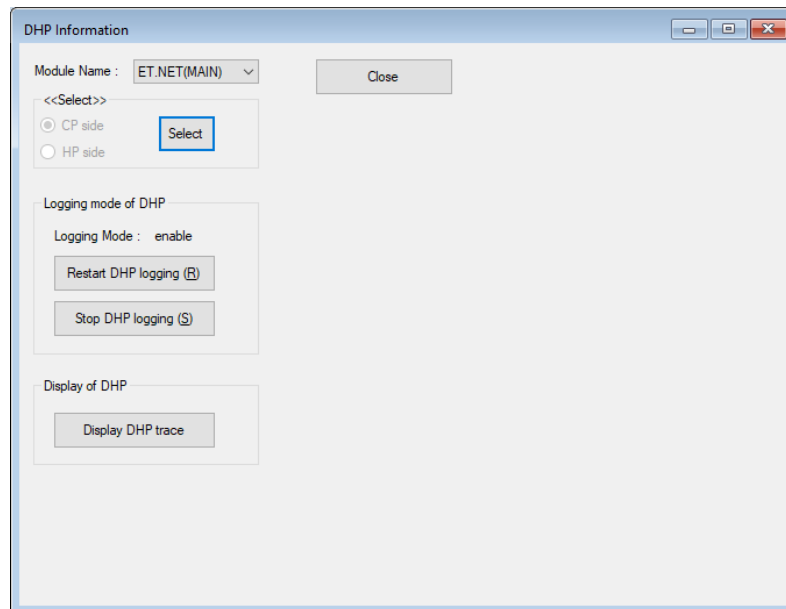

DHP Information window

Click the **Display DHP trace** button to display the DHP trace information within the ET.NET module. Table 13-32 shows the details of the DHP trace information within the ET.NET module. (The trace details are the same as for the CPU module.)

Table 13-32 DHP trace information

No.	Item	Displayed information
1	DHP	The DHP trace display number.
2	TIME	The time at which the trace was recorded. tt.tttttt ↑ Second Time output to one microsecond
3	EVENT	The trace point type.
4	TN	The task number.
5	LV	The priority level.
6	DATA1 to DATA5	The trace data (in hexadecimal format).

Note: DHP tracing includes, in addition to the display of information, settings for the DHP logging mode (permitted or prohibited DHP logging). For details, see *8.4.6.9 RAS menu: DHP Information*.

13. Troubleshooting

(e) Network information

You can view network information for the ET.NET module.

In the ET.NET module network information, you can view sockets, interfaces, memory, routing information, protocols, count information, and various ARP information.

From the BASE SYSTEM/S10VE main menu, click **RAS** and then **Network Information**, and then from the window that appears, select the module that you want to view from the **Selection of the network** drop-down list. To view information from immediately after you make your selection or to view the latest information, click the **Refresh** button.

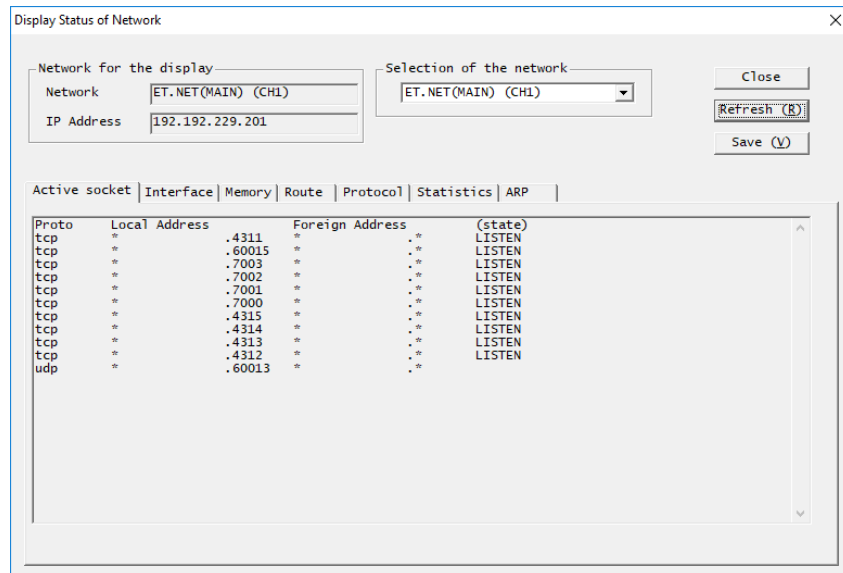

Display Status of Network window

- Socket information

The status of sockets being used is displayed. (Information about both channels is displayed.)

From the Display Status of Network window, click the **Active socket** tab, and then click the **Refresh** button.

Display example

Proto	Local Address	Foreign Address	(state)
tcp	158.212.104.163.60015	158.212.104.162.1200	ESTABLISH
tcp	158.212.104.163.60015	158.212.104.162.1199	TIMEWAIT
tcp	* .7003	* .*	LISTEN
tcp	* .7002	* .*	LISTEN
tcp	* .7001	* .*	LISTEN
tcp	* .7000	* .*	LISTEN
tcp	158.212.104.163.60015	* .*	LISTEN
tcp	* .4305	* .*	LISTEN
tcp	* .4304	* .*	LISTEN
tcp	* .4303	* .*	LISTEN
tcp	* .4302	* .*	LISTEN
udp	* .60013	* .*	

Proto: Protocol name

Local Address: IP address and port number of the local host

Foreign Address: IP address and port number of the remote host

(state): Valid only if Proto is tcp. This item shows the status of the TCP protocol.

CLOSED: Not in use

LISTEN: Wait state of a usable port

SYN_SENT: Connection (SYN) request sent to server, but no response (ACK) received

SYN_RECEIVED: State immediately after connection request received from client

ESTABLISHED: TCP connection established, and communication in progress

FINWAIT1: State in which FIN was transmitted from the server

FINWAIT2: ACK reception state

CLOSEWAIT: State in which FIN was received from the server

LASTACK: ACK wait state with respect to FIN

CLOSING: State in which FIN was received and the connection was closed

TIMEWAIT: Waiting for termination of the connection

13. Troubleshooting

- Interface information

Information about interfaces in use is displayed. (Information about both channels is displayed.) From the Display Status of Network window, click the **Interface** tab, and then click the **Refresh** button.

Display example

```
UNIT NO. 1:
  slot = 0
  kind =EPORT
  MTU = 1500
  IP address      = 192.168.1.11
  netmask         = 255.255.255.0
  broadcast address = 192.168.1.255
  output request count      = 0
  output count(success)    = 532
  output discard error count = 0
  output error count       = 0
  deliver count            = 0
  input count              = 622
  input discard error count = 0
  input error count        = 0
```

UNIT NO.: 1 = Channel 1, 2 = Channel 2

slot: Slot number

kind: Type (EPORT fixed)

MTU: Maximum number of transmitted bytes

IP address: IP address

netmask: Netmask

broadcast address: Broadcast address

output request count: Number of accepted requests for message transmission (not used)

output count(success): Number of successful message transmissions

output discard error count: Number of failed message transmissions due to insufficient memory

output error count: Number of failed message transmissions reported by hardware

deliver count: Number of deliveries of transmitted messages to the user (not used)

input count: Number of message receptions reported by hardware

input discard error count: Number of failed message receptions due to insufficient memory

input error count: Number of failed message receptions reported by hardware

- Memory information

The usage status of the network buffers (mbuf) is displayed. (The usage status for both channels is displayed.) From the Display Status of Network window, click the **Memory** tab, and then click the **Refresh** button.

Display example

```

CURRENT:
XXX/YYY mbufs in use:                               ...(a)
  XXX mbufs allocated to data                        ...(b)
  XXX mbufs allocated to packet headres             ...(c)
  XXX mbufs allocated to socket structures          ...(d)
  XXX mbufs allocated to protocol control blocks    ...(e)
  XXX mbufs allocated to routing table entries      ...(f)
  XXX mbufs allocated to fragment reassemble queue headers ...(g)
  XXX mbufs allocated to socket names and address  ...(h)
  XXX mbufs allocated to socket options            ...(i)
  XXX mbufs allocated to interface addresses       ...(j)
  XXX/YYY Kbytes allocated:(top address 0xZZZZZZZZ)
                                                    ...(k)
  XXX Kbytes allocated to mbufs                    ...(l)
  XXX Kbytes allocated to clusters                  ...(m)
XXX requests for memory denied                      ...(n)
XXX overflows                                       ...(o)
MAX:
XXX/YYY mbufs in use:
:
XXX/YYY Kbytes allocated:
:
HIGH:
XXX/YYY mbufs in use:
:
XXX/YYY Kbytes allocated:
:
DROP:
XXX/YYY mbufs in use:
:
XXX/YYY Kbytes allocated:
:
XXX requests for memory denied
XXX overflows

```

13. Troubleshooting

Description

CURRENT: Current state of mbufs

MAX: The state of mbufs at maximum usage

HIGH: Peak value of each item

DROP: The state of mbufs at overflow (Not displayed if an overflow never occurs.)

- (a) The number of mbufs in use (XXX) / Total number of mbufs (YYY)
- (b) The number of mbufs that store communication data (XXX)
- (c) The number of mbufs that store packet headers (XXX)
- (d) The number of mbufs that store the socket table (XXX)
- (e) The number of mbufs that store the protocol control table (XXX)
- (f) The number of mbufs that store routing table entries (XXX)
- (g) The number of mbufs that store data waiting for IP reassembly (XXX)
- (h) The number of mbufs that store socket addresses (XXX)
- (i) The number of mbufs that store socket options (XXX)
- (j) The number of mbufs that store network interface addresses (XXX)
- (k) Cluster memory size currently in use (XXX) / Total memory size allocated for clusters (XXX)
mbuf initial address (0xZZZZZZZZ)
- (l) Memory size used as mbufs (XXX)
- (m) Memory size used as clusters (XXX)
- (n) The number of times mbufs or clusters could not be allocated because no clusters were available (XXX)
- (o) The number of times clusters were requested after the number of clusters in use reached the maximum limit (XXX)

For items (b) through (j), (l), and (m), the corresponding line is not displayed if the value is 0.

- Routing information

The routing information currently being managed is displayed. (Information about the specified channel is displayed.) From the Display Status of Network window, click the **Route** tab, and then click the **Refresh** button.

Display example

Interface Infomation:					
Destination	Gateway	Flags	Refcnt	Metric	Interface
192.168.1.0	192.168.1.11	U	8	0	EPORT1
Generation Infomation:					
Destination	Gateway	Metric	Interface		

Destination: Network address of the final destination network

Gateway: IP address of the gateway

Flags: Status flags of the gateway routing information for the destination

U: Indicates that the route is operational

G: Indicates that the route leads to a gateway

H: Indicates that the destination is a host

Refcnt: Number of times that the routing information is currently used

Metric: The number of hops to the destination network or host

Interface: Channel number of the interface to which the routing information belongs

13. Troubleshooting

- Protocols

The following protocol information is available: IP (Internet Protocol) statistical information, ICMP (Internet Control Message Protocol) statistical information, TCP (Transmission Control Protocol) statistical information, and UDP (User Datagram Protocol) statistical information.

From the Display Status of Network window, click the **Protocol** tab, and then click the **Refresh** button.

- IP (Internet Protocol) statistical information

Protocol statistics for the IP layer are displayed. (Statistical values are the total values for both channels.)

Display example

ip:		
0 total packets received		...(a)
0 errors in IP headers		...(b)
0 invalid IP address		...(c)
0 packets forwarded		...(d)
0 unknown (or unsupported) protocol		...(e)
0 input packets discarded		...(f)
0 in delivered		...(g)
0 out requests		...(h)
0 output packets discarded		...(i)
0 packets discarded because no route		...(j)
0 fragments received		...(k)
0 packets successfully reassembled		...(l)
0 failures detected by the IP reassembly algorithm		...(m)
0 packets fragmented		...(n)
0 packets discard for they could not be fragmented		...(o)
0 fragments have been generated		...(p)
0 routing entries were discarded		...(q)

- (a) Total number of received IP packets
- (b) Total number of discarded packets due to IP header errors
- (c) Total number of discarded packets due to incorrect destination addresses
- (d) Total number of forwarded packets
- (e) Total number of discarded packets due to unknown or unsupported protocols
- (f) Total number of discarded receive packets due to buffer overflows or other reasons
- (g) Total number of received packets passed to upper protocols
- (h) Total number of packets requested by upper protocols to be transmitted (excluding (d))
- (i) Total number of discarded transmit packets due to buffer overflows or other reasons
- (j) Total number of discarded packets due to lack of routing information for the destination addresses
- (k) Total number of received fragments
- (l) Total number of successfully reassembled fragments
- (m) Total number of failures detected during reassembly of fragments
- (n) Total number of successfully fragmented packets
- (o) Total number of packets that required fragmentation but were discarded because fragmentation failed
- (p) Total number of created fragments
- (q) Total number of discarded routing entries

- ICMP (Internet Control Message Protocol) statistical information

Protocol statistics for the ICMP layer are displayed. (Statistical values are the total values for both channels.)

Display example

```
icmp:
  0 messages recieved                ...(a)
  0 error messages                   ...(b)
  0 destination unreachable          ...(c)
  0 time exceeded                    ...(d)
  0 parameter problem                ...(e)
  0 source quench                    ...(f)
  0 redirect                         ...(g)
  0 echo                             ...(h)
  0 echo reply                       ...(i)
  0 timestamp                        ...(j)
  0 timestamp reply                  ...(k)
  0 address mask request             ...(l)
  0 address mask reply               ...(m)
  0 messages sent                   ...(n)
  0 error messages                   ...(o)
  0 destination unreachable          ...(p)
  0 time exceeded                    ...(q)
  0 parameter problem                ...(r)
  0 source quench                    ...(s)
  0 redirect                         ...(t)
  0 echo                             ...(u)
  0 echo reply                       ...(v)
  0 timestamp                        ...(w)
  0 timestamp reply                  ...(x)
  0 address mask request             ...(y)
  0 address mask reply               ...(z)
```

13. Troubleshooting

- (a) Total number of received ICMP messages (including (b))
- (b) Total number of received ICMP messages with errors
- (c) Total number of received ICMP "Destination Unreachable" messages
- (d) Total number of received ICMP "Time Exceeded" messages
- (e) Total number of received ICMP "Parameter Problem" messages
- (f) Total number of received ICMP "Source Quench" messages
- (g) Total number of received ICMP "Redirect" messages
- (h) Total number of received ICMP "Echo" messages
- (i) Total number of received ICMP "Echo Reply" messages
- (j) Total number of received ICMP "Timestamp" messages
- (k) Total number of received ICMP "Timestamp Reply" messages
- (l) Total number of received ICMP "Address Mask Request" messages
- (m) Total number of received ICMP "Address Mask Reply" messages
- (n) Total number of transmitted ICMP messages (including (o))
- (o) Total number of transmitted ICMP messages with errors
- (p) Total number of transmitted ICMP "Destination Unreachable" messages
- (q) Total number of transmitted ICMP "Time Exceeded" messages
- (r) Total number of transmitted ICMP "Parameter Problem" messages
- (s) Total number of transmitted ICMP "Source Quench" messages
- (t) Total number of transmitted ICMP "Redirect" messages
- (u) Total number of transmitted ICMP "Echo" messages
- (v) Total number of transmitted ICMP "Echo Reply" messages
- (w) Total number of transmitted ICMP "Timestamp" messages
- (x) Total number of transmitted ICMP "Timestamp Reply" messages
- (y) Total number of transmitted ICMP "Address Mask Request" messages
- (z) Total number of transmitted ICMP "Address Mask Reply" messages

In the ICMP information, the cumulative total values are displayed only when the relevant packets are sent or received, with the exception of (a) and (n).

- TCP (Transmission Control Protocol) statistical information

Protocol statistics for the TCP layer are displayed. (Statistical values are the total values for both channels.)

Display example

tcp:		
0 active opens		...(a)
0 passive opens		...(b)
0 attempt fails		...(c)
0 establish resets		...(d)
0 current establish		...(e)
0 segments received		...(f)
0 segments sent		...(g)
0 segments retransmit		...(h)
0 segments received in error		...(i)
0 segments sent containing the RST flag		...(j)

(a) Total number of active opens

(b) Total number of passive opens

(c) Total number of transitions from SYN-SENT or SYN-RCVD to CLOSE

(d) Total number of transitions from ESTABLISHED or CLOSE-WAIT to CLOSE

(e) Number of TCP connections currently in the ESTABLISHED or CLOSE-WAIT state

(f) Total number of received packets

(g) Total number of transmitted packets

(h) Total number of retransmitted packets

(i) Total number of received packets with errors

(j) Total number of packets transmitted with the RST flag ON

- UDP (User Datagram Protocol) statistical information

Protocol statistics for the UDP layer are displayed. (Statistical values are the total values for both channels.)

Display example

udp:		
0 packets recieved		...(a)
0 no application at the destination port		...(b)
0 packets recieved in error		...(c)
0 packets sent		...(d)

(a) Total number of received packets

(b) Total number of received packets without an application at the destination port

(c) Total number of received packets with errors other than (b)

(d) Total number of transmitted packets

13. Troubleshooting

- Count information

You can view the count information in use. From the Display Status of Network window, click the **Statistics** tab, and then click the **Refresh** button.

The following describes the count information for the ET.NET module.

The count information consists of the LANCTL (LSI) count information and the network driver count information. The count values of the specified channel are displayed, but some of the count values are the total count values from both channels.

Table 13-33 Count information (1/7)

No.	Description	Category
LOGOUT:001	Normal received frame count	LANCTL (startup/interrupt) count information (per channel)
LOGOUT:002	Number of frames received from LAN (including both normal and error frames)	
LOGOUT:003	Number of frames transmitted to LAN	
LOGOUT:004	Total number of bytes in the frames received from LAN	
LOGOUT:005	Total number of bytes in the frames transmitted to LAN	
LOGOUT:006	Number of error frames received	
LOGOUT:007	Number of LSI received data size errors	
LOGOUT:008	Number of LSI CRC errors (including alignment errors)	
LOGOUT:009	Number of LSI carrier extension errors	
LOGOUT:010	Number of LSI sequence errors	
LOGOUT:011	Number of LSI symbol errors	
LOGOUT:012	Number of errors with no LSI reception interrupt cause	
LOGOUT:013	Number of illegal SA frames received	
LOGOUT:014	LS reception buffer BUSY count	
LOGOUT:015	Reception tail out-of-range detection count	
LOGOUT:016	Transmitted error frame count	
LOGOUT:017	LSI late collision count	
LOGOUT:018	LSI retry error count	
LOGOUT:019	Number of errors with no LSI transmission interrupt cause	
LOGOUT:020	Transmission tail out-of-range detection count	
LOGOUT:021	Transmission monitor timeout count	
LOGOUT:022	Number of transmission monitor timeouts due to link down contention	
LOGOUT:023	Number of transmission failures due to link off	
LOGOUT:024	Number of transmission failures due to LANCTL initialization	
LOGOUT:025	LANCTL reinitialization count	
LOGOUT:026	Reserved	
LOGOUT:027	Reserved	
LOGOUT:028	Reserved	
LOGOUT:029	Reserved	
LOGOUT:030	Reserved	
LOGOUT:031	Reserved	
LOGOUT:032	Reserved	
LOGOUT:033	Reserved	
LOGOUT:034	Reserved	
LOGOUT:035	Reserved	
LOGOUT:036	Number of LSI receive sequence errors	
LOGOUT:037	Number of LSI receive overrun errors	
LOGOUT:038	Number of LSI transmission queue underflow errors	
LOGOUT:039	Number of LSI link status changes	
LOGOUT:040	Number of times LSI reception descriptor final value reached	

Table 13-33 Count information (2/7)

No.	Description	Category
LOGOUT:041	Normal received frame count	LANCTL (fixed cycle) count information (by channel)
LOGOUT:042	Normal transmission frame count	
LOGOUT:043	Received frame count (64 bytes)	
LOGOUT:044	Received frame count (65 to 127 bytes)	
LOGOUT:045	Received frame count (128 to 255 bytes)	
LOGOUT:046	Received frame count (256 to 511 bytes)	
LOGOUT:047	Received frame count (512 to 1,023 bytes)	
LOGOUT:048	Received frame count (1,024 to max bytes)	
LOGOUT:049	Received broadcast frame count	
LOGOUT:050	Transmitted frame count (64 bytes)	
LOGOUT:051	Transmitted frame count (65 to 127 bytes)	
LOGOUT:052	Transmitted frame count (128 to 255 bytes)	
LOGOUT:053	Transmitted frame count (256 to 511 bytes)	
LOGOUT:054	Transmitted frame count (512 to 1,023 bytes)	
LOGOUT:055	Transmitted frame count (1,024 to max bytes)	
LOGOUT:056	Transmitted broadcast frame count	
LOGOUT:057	Number of error frames received	
LOGOUT:058	Number of illegal-length frames received	
LOGOUT:059	Number of reception CRC errors	
LOGOUT:060	Number of reception alignment errors	
LOGOUT:061	Number of reception RX errors	
LOGOUT:062	Missed packet count	
LOGOUT:063	Reception descriptor BUSY count	
LOGOUT:064	Number of reception fragment errors	
LOGOUT:065	Number of reception jabber errors	
LOGOUT:066	Reserved	
LOGOUT:067	Reserved	
LOGOUT:068	Reserved	
LOGOUT:069	Transmitted error frame count	
LOGOUT:070	Collision retry limit exceeded count	
LOGOUT:071	Late collision count	
LOGOUT:072	Number of carrier extension errors	
LOGOUT:073	Single collision count	
LOGOUT:074	Multiple collision count	
LOGOUT:075	Transmission delay count	
LOGOUT:076	Reserved	
LOGOUT:077	Reserved	
LOGOUT:078	Reserved	
LOGOUT:079	Reserved	
LOGOUT:080	Reserved	

Table 13-33 Count information (3/7)

No.	Description	Category
LOGOUT:081	Reserved	lance_ctl table information (common to both channels)
LOGOUT:082	Reserved	
LOGOUT:083	Reserved	
LOGOUT:084	Reserved	
LOGOUT:085	Reserved	
LOGOUT:086	Cluster over count	
LOGOUT:087	Total invalid interrupt count	
LOGOUT:088	Total number of invalid interrupt errors (subcategory: processor type)	
LOGOUT:089	Total number of invalid interrupt errors (subcategory: unit number)	
LOGOUT:090	Number of socket overflow errors	
LOGOUT:091	Network buffer (mbuf) overflow error count	
LOGOUT:092	Network buffer (mbuf) free error count	
LOGOUT:093	Number of consecutive invalid interrupt errors	
LOGOUT:094	Channel 1 mounting information	
LOGOUT:095	Channel 2 mounting information	
LOGOUT:096	Reserved	
LOGOUT:097	Number of sockets currently in use	
LOGOUT:098	Number of times packets were discarded due to IP reception queue overflow	
LOGOUT:099	Number of TCP transmission errors	
LOGOUT:100	Reserved	
LOGOUT:101	Reserved	
LOGOUT:102	Reserved	
LOGOUT:103	Reserved	
LOGOUT:104	Reserved	
LOGOUT:105	Reserved	
LOGOUT:106	Reserved	
LOGOUT:107	Reserved	
LOGOUT:108	Reserved	Driver management information (by channel)
LOGOUT:109	LANCTL register base address	
LOGOUT:110	Count information table address	
LOGOUT:111	Descriptor logical base address	
LOGOUT:112	Descriptor physical base address	
LOGOUT:113	LANCTL status	
LOGOUT:114	Jumbo frame support status	
LOGOUT:115	Communication settings	
LOGOUT:116	Previous communication settings	
LOGOUT:117	Management table address for the transmission DMA buffer	
LOGOUT:118	Management table address for the reception DMA buffer	
LOGOUT:119	Reserved	
LOGOUT:120	Reserved	

Table 13-33 Count information (4/7)

No.	Description	Category
LOGOUT:121	Initial mbuf address of the IP reception queue	IP queue information (common to both channels)
LOGOUT:122	Final mbuf address of the IP reception queue	
LOGOUT:123	Packet size of the IP reception queue	
LOGOUT:124	Maximum packet size of the IP reception queue	
LOGOUT:125	Number of times packets were discarded due to IP reception queue overflow	
LOGOUT:126	Initial mbuf address of the RAW reception queue	RAW queue information (common to both channels)
LOGOUT:127	Final mbuf address of the RAW reception queue	
LOGOUT:128	Packet size of the RAW reception queue	
LOGOUT:129	Maximum packet size of the RAW reception queue	
LOGOUT:130	Number of times packets were discarded due to RAW receive queue overflow	
LOGOUT:131	Status flag (upper 2 bytes)	netdev table information (by channel)
	Device number (lower 2 bytes)	
LOGOUT:132	Upper 4 bytes of the MAC address	
LOGOUT:133	Lower 2 bytes of the MAC address	
LOGOUT:134	Unit number	
LOGOUT:135	Next netdev table address	
LOGOUT:136	Interrupt module function address	
LOGOUT:137	RX interrupt module function address	
LOGOUT:138	TX module function address	
LOGOUT:139	Input error collection area address	
LOGOUT:140	Output error collection area address	
LOGOUT:141	Transmission start flag	
LOGOUT:142	Transmission timeout count	
LOGOUT:143	Transmission completion monitoring timer ID	
LOGOUT:144	Initial timeout error	
LOGOUT:145	Initial completion flag	
LOGOUT:146	Reception interrupt timer registration flag	
LOGOUT:147	Reception interrupt timer ID	
LOGOUT:148	Reserved	
LOGOUT:149	Reserved	
LOGOUT:150	Reserved	

Table 13-33 Count information (5/7)

No.	Description	Category
LOGOUT:151	Interface name address	ifnet table information (by channel)
LOGOUT:152	Interface number (upper 2 bytes) MTU (lower 2 bytes)	
LOGOUT:153	Status flag Timer	
LOGOUT:154	Routing metric (external only)	
LOGOUT:155	Address of the ifaddr table	
LOGOUT:156	Initial mbuf address of the transmission queue	
LOGOUT:157	Final mbuf address of the transmission queue	
LOGOUT:158	Packet size of the transmission queue	
LOGOUT:159	Maximum packet size of the transmission queue	
LOGOUT:160	Number of times packets were discarded due to transmission queue overflow	
LOGOUT:161	init routine address	
LOGOUT:162	Output routine address	
LOGOUT:163	ioctl routine address	
LOGOUT:164	Bus reset routine address	
LOGOUT:165	Timer routine address	
LOGOUT:166	Start I/O routine address	
LOGOUT:167	Received packet count	
LOGOUT:168	Number of received packets with errors	
LOGOUT:169	Transmitted packet count	
LOGOUT:170	Number of transmitted packets with errors	
LOGOUT:171	Collision detection count	
LOGOUT:172	Unit number	
LOGOUT:173	Slot number (upper 2 bytes) Major number (lower 2 bytes)	
LOGOUT:174	System configuration information (adapter) table address	
LOGOUT:175	Reserved	
LOGOUT:176	Reserved	
LOGOUT:177	Reserved	
LOGOUT:178	Module status (upper 2 bytes) LINK, 10 M/100 Mbps, full/half duplex status (lower 2 bytes)	
LOGOUT:179	G-ARP transmission count (upper 2 bytes) Module ID (lower 2 bytes)	
LOGOUT:180	Reserved	
LOGOUT:181	Reserved	
LOGOUT:182	Next ifnet table address	IP count information (common to both channels)
LOGOUT:183	Total packets received	
LOGOUT:184	Checksum bad	
LOGOUT:185	Packet too short	
LOGOUT:186	Not enough data	
LOGOUT:187	IP header length less than data size	
LOGOUT:188	IP length less than IP header length	
LOGOUT:189	Fragments received	
LOGOUT:190	Fragments dropped (duplicates, out of space)	
LOGOUT:191	Fragments timed out	
LOGOUT:192	Packets forwarded	
LOGOUT:193	Packets received for unreachable destination	
LOGOUT:194	Packets forwarded on same network	

Table 13-33 Count information (6/7)

No.	Description	Category
LOGOUT:195	UDP head drop	UDP count information (common to both channels)
LOGOUT:196	UDP bad checksum	
LOGOUT:197	UDP bad length	
LOGOUT:198	Connections initiated	TCP count information (common to both channels)
LOGOUT:199	Connections accepted	
LOGOUT:200	Connections established	
LOGOUT:201	Connections dropped	
LOGOUT:202	Embryonic connections dropped	
LOGOUT:203	Connections closed (includes drops)	
LOGOUT:204	Segments where attempts to acquire RTT were made	
LOGOUT:205	Times successful	
LOGOUT:206	Delayed ACK sent	
LOGOUT:207	Connections dropped in retransmission timeouts	
LOGOUT:208	Retransmission timeouts	
LOGOUT:209	Persistence timeouts	
LOGOUT:210	Keepalive timeouts	
LOGOUT:211	Keepalive probes sent	
LOGOUT:212	Connections dropped in keepalive	
LOGOUT:213	Total packets sent	
LOGOUT:214	Data packets sent	
LOGOUT:215	Data bytes sent	
LOGOUT:216	Data packets retransmitted	
LOGOUT:217	Data bytes retransmitted	
LOGOUT:218	ACK-only packets sent	
LOGOUT:219	Window probes sent	
LOGOUT:220	Packets sent with URG only	
LOGOUT:221	Window update-only packets sent	
LOGOUT:222	Control (SYN, FIN, RST) packets sent	
LOGOUT:223	Total packets received	
LOGOUT:224	Packets received in sequence	
LOGOUT:225	Bytes received in sequence	
LOGOUT:226	Packets received with checksum errs	
LOGOUT:227	Packets received with bad offset	
LOGOUT:228	Packets received that were too short	
LOGOUT:229	Duplicate-only packets received	
LOGOUT:230	Duplicate-only bytes received	
LOGOUT:231	Packets with some duplicate data	
LOGOUT:232	Bytes containing the duplicated data	
LOGOUT:233	Out-of-order packets received	
LOGOUT:234	Out-of-order bytes received	
LOGOUT:235	Packets with data after window	
LOGOUT:236	Bytes received after window	
LOGOUT:237	Packets received after "close"	
LOGOUT:238	Received window probe packets	
LOGOUT:239	Received duplicate ACK	
LOGOUT:240	Received ACK for unsent data	
LOGOUT:241	Received ACK packets	
LOGOUT:242	Received ACK bytes	
LOGOUT:243	Received window update packets	
LOGOUT:244	Send RST packets	

Table 13-33 Count information (7/7)

No.	Description	Category
LOGOUT:245	Number of times consecutive channel errors occurred for LANCTL stop control	Device management table information (by channel)
LOGOUT:246	Number of times carrier loss occurred consecutively for error output suppression	
LOGOUT:247	Number of consecutive retry errors for error output suppression	
LOGOUT:248	Number of consecutive late collisions for error output suppression	
LOGOUT:249	Reserved	
LOGOUT:250	No reception data count	
LOGOUT:251	Number of timer registrations due to reception interrupt processing division	
LOGOUT:252	Reserved	
LOGOUT:253	--	Reserved
LOGOUT:254	--	
LOGOUT:255	--	
LOGOUT:256	--	

Description of LOGOUT:178 details

Category	bit position	Description	Notes
Transmission state	0-14	Transmission speed, transmission type 0: Initial state 1: 100 Mbps full duplex 2: 100 Mbps half duplex 3: 10 Mbps full duplex 4: 10 Mbps half duplex	#1
	15	Link status (0: down, 1: up)	#2
Module status	16	Reserved	
	17	Reserved	
	18	Operational state (0: normal, 1: abnormal termination)	
	19-23	Reserved	
	24	Duplicate IP address (0: not detected, 1: detected)	Whether detection occurred after initialization was complete
	25-31	Reserved	

#1: The current state of the transmission speed and transmission type are reflected on a cycle of 1 second in the link-up state. (In the link-down state, the state from immediately before the link transitioned from up to down is retained.)

#2: The current link state is reflected on a cycle of 1 second.

- ARP

You can view the ARP information in use.

From the Display Status of Network window, click the **ARP** tab, and then click the **Refresh** button.

Display example

```

ARP Infomation of uno = 1, kind = EPORT.
Interface Infomation: count = 2
  Internet Address      Physical Address      Type      Time
  192.168.1.1          1c:c1:de:9f:c9:3a    dynamic   2
  192.168.1.2          00:00:87:a0:00:24    static

```

uno: 1 = Channel 1, 2 = Channel 2

kind: Interface type (EPORT fixed)

count: Amount of ARP information being managed

Internet Address: IP address

Physical Address: MAC address

Type: Registration type (dynamic or static)

Time: For dynamic registration, the amount of time not in use (in minutes) that has passed since registration

13.2.3 Remote I/O communication troubleshooting

This section describes how to perform remote I/O communication troubleshooting.

13.2.3.1 Troubleshooting procedure

Use the MCS of BASE SYSTEM/S10VE (see 8.4.6.4 RAS menu: MCS) to check the status of the system register (registered station, timeout station) and the LED status of the station module and remote I/O optical adapter, and then perform troubleshooting.

(1) Procedure for PI/O unit troubleshooting

If the sent and received data does not match the relationship between input and output, perform troubleshooting with respect to the PI/O modules and station modules installed in the PI/O unit.

Figure 13-20 shows the troubleshooting procedure.

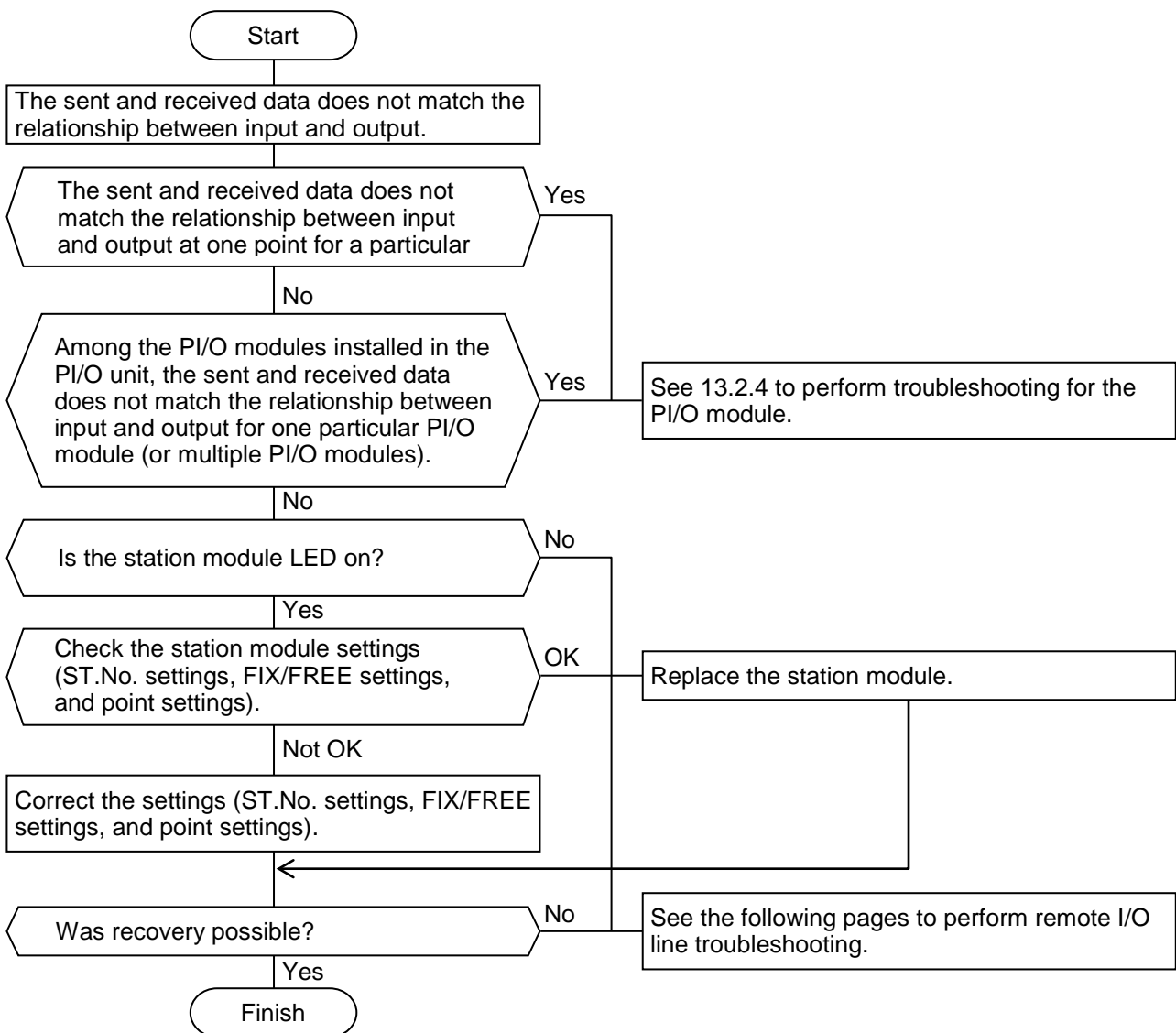

Figure 13-20 Troubleshooting procedure for the PI/O unit

- (2) Troubleshooting procedure for the remote I/O line
 If a timeout has occurred in a station module connected to the remote I/O line, follow the instructions in Figure 13-21 to troubleshoot the problem.

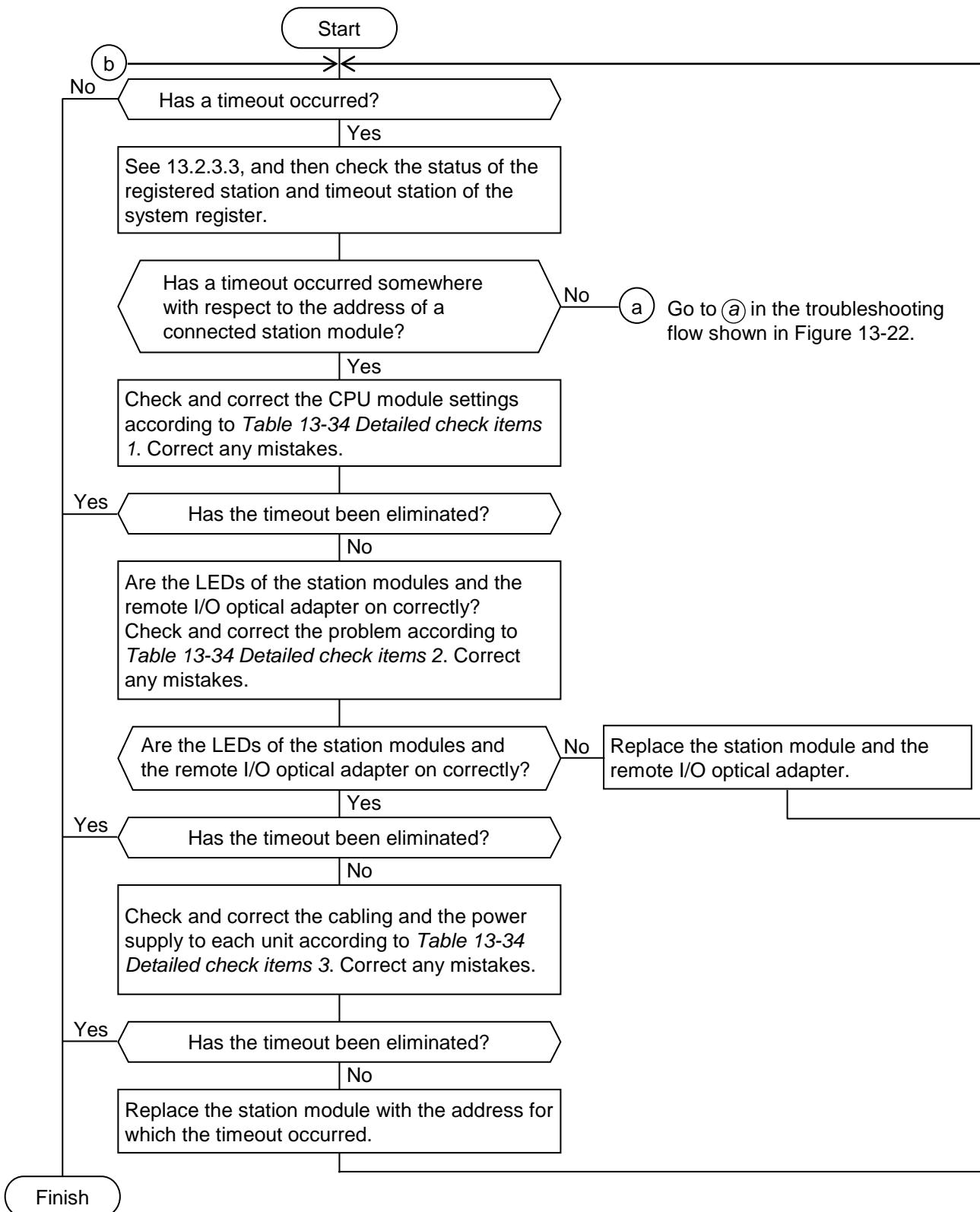
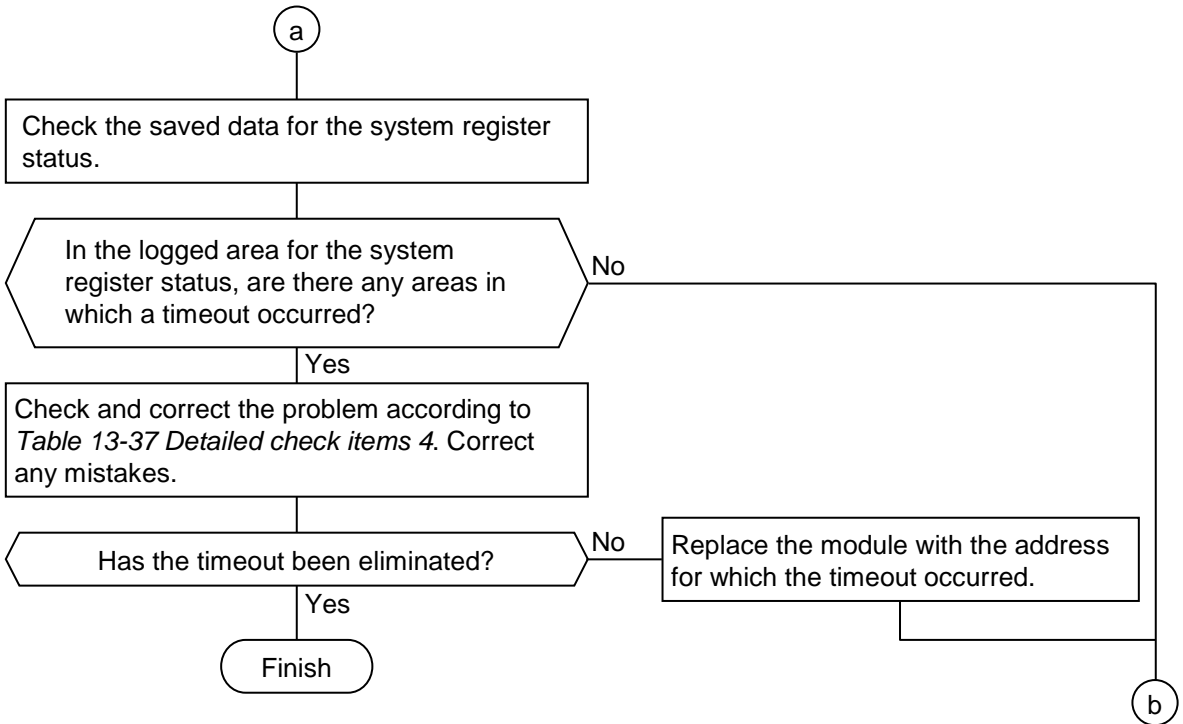

Figure 13-21 Troubleshooting procedure for the remote I/O line

13. Troubleshooting

If a timeout occurs intermittently in a station module connected to the remote I/O line, follow the instructions in Figure 13-22 to troubleshoot the problem.



Go to (b) in the troubleshooting flow shown in Figure 13-21.

Figure 13-22 Troubleshooting procedure for intermittent timeouts

Notice

- In remote I/O communication, there is no way to view error information besides checking the system register and looking at the LED indicators on the station module and remote I/O optical adapter. There is no way to determine from the contents of the received data whether the data was transmitted normally or a time out occurred. This means that in a large-scale or wide area system that has been built using remote I/O optical adapters, it takes a long time to analyze the cause when an issue arises. Because the system register and LED indicators provide current status information, the operator can identify the source of a persistent error, such as that caused by a failed module. However, identifying the source of an error that manifests intermittently such as a partial cable disconnection takes much more time. Given this difficulty in identifying the source of errors related to remote I/O communication, you must keep the following in mind with the objective of streamlining the process of failure analysis when a failure occurs:

A module such as OD.RING makes it easier to analyze faults on a line. Consider using it in your system design where doing so is cost-effective.

- Design the system in a way that considers fault analysis, through such means as centralized installation and PI/O unit aggregation.
 - Prepare an allocation table that shows the correspondence of I/O signals and PI/O addresses with respect to the entire system configuration. This allows you to identify the location of the fault when an issue with data occurs at the application level, such as data not being updated due to a timeout.
 - The CPU module of the S10VE system does not perform external notification if the remote I/O line times out. It is the responsibility of the user to use a program that monitors the system register at the control cycle level and identifies when a timeout occurs.
 - To identify the source of an intermittent fault, it is the responsibility of the user to use a program that saves to memory all areas of the system register related to the remote I/O line when a timeout occurs.
 - Tag each optical cable with its line number to prevent incorrect connection of the remote I/O optical adapter and optical cables.
- If multiple remote I/O optical adapters are installed together, turning off the power supply module of the CPU unit for maintenance of the remote I/O optical adapter prevents any further remote I/O communication that involves the remote I/O optical adapters. When designing the system, consider your maintenance procedures when implementing remote I/O optical adapters.

13. Troubleshooting

13.2.3.2 Detailed check items

Check the items in Table 13-34 with respect to locations for which a timeout occurred.

- (1) Check items for when a failure occurs repeatedly

Table 13-34 Check items for when a failure occurs repeatedly

No.	Item	Check item	Notes
1	Detailed check items 1	Are the I/O points and optical adapter settings for the remote I/O settings specified to the CPU module correct? If any mistakes are present, correct the settings.	When connecting an optical adapter to the remote I/O line, for Optical adapter connection(D) when specifying the RI/O settings, specify Connect .
		Are the PI/O installation, FIX/FREE, and slot point settings for the PI/O settings specified to the CPU module correct? If any mistakes are present, correct the settings.	
2	Detailed check items 2	If the station module LED (RI/O) is off, take corrective action according to Figure 13-23 and Table 13-35.	
		If the remote I/O optical adapter LEDs (OPT TX, OPT RX, RIO TX, and RIO RX) are off, take corrective action according to Figure 13-24 and Table 13-36.	
3	Detailed check items 3	Are the station module settings (ST.No. settings, FIX/FREE settings, and I/O point settings) correct? If any incorrect settings are present, correct the settings.	
		Are the cables connected to the terminal block loose or are any cables disconnected? If any cabling is loose or disconnected, tighten the cabling connected to the terminal block or replace the cables.	
		Are the termination resistor screws loose or are there any problems with the termination resistor value connection? Correct any loose screws or mistakes in the termination resistor value, and ensure that the cabling is correct.	The termination resistor values vary depending on the cables that are in use.
		Is the cable length for the remote I/O line correct? If the cables are too long, use cables of the correct length.	For details about cable length, see Chapter 7.
		Is the length of the optical cables less than or equal to 1 km per section? If the cables are too long, use cables of a length that is less than or equal to 1 km.	
		Is the number of optical line sections less than or equal to three? If the number of optical line sections is four or more, lower the number of sections to three or less.	

Troubleshooting from the station module LEDs

When creating the station module connection configuration depicted in Figure 13-23, check the LED status of the station modules to identify the locations of failures that occur.

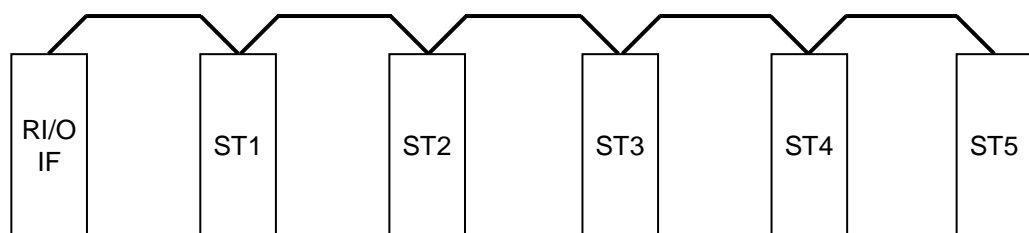

ST1 to ST5: Remote I/O station modules

Figure 13-23 Example station module connection configuration

Table 13-35 Analyzing failures from the station module LEDs

No.	Failure location	Remote I/O LEDs of the station module					Corrective action
		ST1	ST2	ST3	ST4	ST5	
1	--	ON	ON	ON	ON	ON	The location of the failure cannot be determined from the LEDs. Return to the troubleshooting flow in Figure 13-21, and investigate the failure according to the instructions in Nos. 2 through 4.
2	RI/O-IF module failure or incorrect cabling for the terminal block	OFF	OFF	OFF	OFF	OFF	If all station module LEDs are off, the following might have occurred: an RI/O-IF module error, errors in the cabling of the RI/O-IF or ST1 terminal blocks, or disconnection of a remote I/O cable between the RI/O-IF and ST1. Investigate the RI/O-IF module, the terminal block cabling, and the remote I/O cable.
3	Remote I/O cable disconnection or incorrect cabling for the station module terminal block	ON	ON	OFF	OFF	OFF	If the LEDs of a particular station module and the modules thereafter are off, there might be a disconnected cable or a mistake in the cabling of the terminal block for the station modules. For example, if the LEDs are off for the station modules from ST3 onward as shown to the left, a remote I/O cable might be disconnected between ST2 and ST3, or there might be a mistake in the cabling of the terminal block for ST2 or ST3. Check the remote I/O cable and the terminal block cabling.
4	Station module failure or an error in the power for the unit in which the station module is installed	ON	ON	OFF	ON	ON	If the LEDs of a particular station module are off, there might be a station module error or an error in the power of a unit. For example, if the LEDs of ST3 are off as shown to the left, check the ST3 station module or the power of the unit.

ON: LED on, OFF: LED off

13. Troubleshooting

Troubleshooting from the remote I/O optical adapter LEDs

When creating the remote I/O optical adapter connection configuration depicted in Figure 13-24, identify the location of the failure by using the combination of LED status for the remote I/O optical adapter.

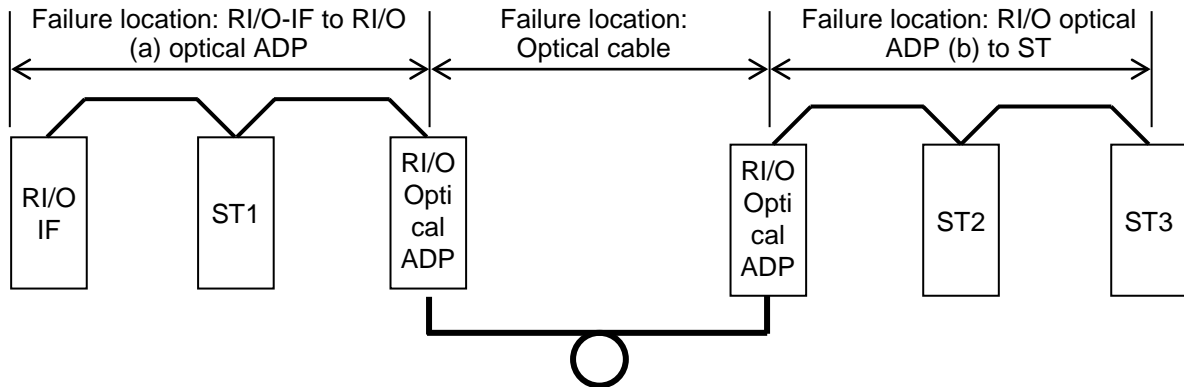

ST1 to ST3: Remote I/O station modules
 RI/O optical ADP (a), (b): Remote I/O optical adapter

Figure 13-24 Remote I/O optical adapter failure locations

Table 13-36 Analyzing failures from remote I/O optical adapter LEDs

No.	Failure location	LED status of the RI/O optical ADP (a)				LED status of the RI/O optical ADP (b)				Corrective action
		OPT TX	OPT RX	RI/O TX	RI/O RX	OPT TX	OPT RX	RI/O TX	RI/O RX	
1	No failure Normal	ON	ON	ON	ON	ON	ON	ON	ON	The location of the failure cannot be determined from the LEDs. Return to the troubleshooting flow in Figure 13-21, and investigate the failure according to the instructions in Nos. 2 through 15.
2	A failure occurred in the cabling between the RI/O-IF and RI/O optical ADP (a), a cable, or a module	OFF	OFF	OFF	OFF	OFF	OFF	OFF	OFF	An error might be present in the remote I/O cable. Check the connection of the remote I/O cable and the termination resistor.
3		ON	OFF	OFF	ON	OFF	ON	OFF	OFF	There might be a problem with the power of the unit in which the RI/O optical ADP (a) is installed. Check the power status.
4		OFF	--	--	ON	--	--	--	--	An error might be present in the RI/O-IF module. Investigate the RI/O-IF module.
5		ON	ON	OFF	ON	ON	ON	OFF	OFF	Check the rotary switch settings of the RI/O optical ADP (a).
6		OFF	--	--	ON	--	--	--	--	An error exists in the RI/O optical ADP (a). Replace the RI/O optical ADP (a).
7		--	ON	OFF	--	--	--	--		An error exists in the RI/O optical ADP (a). Replace the RI/O optical ADP (a).
8	An error occurred in the optical cable.	ON	OFF	OFF	ON	OFF	OFF	OFF	OFF	An error might be present in the optical cable. Verify the optical cable and the connection.
9		ON	ON	ON	ON	ON	ON	ON	ON	
10	A failure occurred in the cabling between the I/O optical ADP (b) and ST3, a cable, or a module.	OFF	OFF	OFF	OFF	OFF	OFF	OFF	OFF	There might be a problem with the power of the unit in which the RI/O optical ADP (b) is installed. Check the power status.
11		ON	OFF	OFF	ON	OFF	ON	ON	OFF	An error might be present in the remote I/O cable. Check the connection of the remote I/O cable and the termination resistor.
12		ON	ON	ON	ON	ON	ON	ON	ON	An error might be present in the station module. Check the status and power of the station module.
13		ON	ON	OFF	ON	ON	ON	OFF	OFF	Check the rotary switch settings of the RI/O optical ADP (b).
14		--	--	--	--	OFF	--	--	ON	An error exists in the RI/O optical ADP (b). Replace the RI/O optical ADP (b).
15		--	--	--	--	ON	OFF	--		An error exists in the RI/O optical ADP (b). Replace the RI/O optical ADP (b).

ON: LED on, OFF: LED off, --: No relation to LED status

- (2) Check items for when a failure occurs intermittently

Table 13-37 Check items for when a failure occurs intermittently

No.	Item	Check item	Notes
1	Detailed check items 4	If only station modules are connected to the remote I/O line, take corrective action according to Figure 13-25 and Table 13-38.	
		If you are using a remote I/O optical adapter on the remote I/O line, take corrective action according to Figure 13-26 and Table 13-39.	

Troubleshooting from the station modules

When an intermittent failure (timeout) occurs in a configuration consisting only of station modules, identify the failed location by using the location in which the timeout occurred.

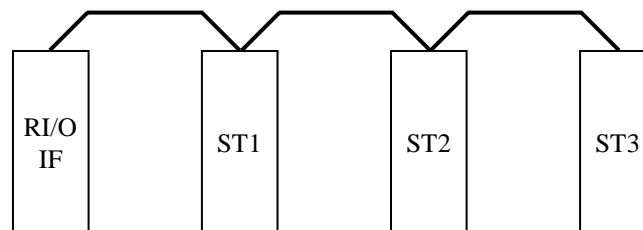

ST1 to ST3: Remote I/O station modules

Figure 13-25 Example station module connection configuration

Table 13-38 Failure analysis when a failure occurs intermittently 1

No.	Timeout location of occurrence			Corrective action
	ST1	ST2	ST3	
1	ON	ON	ON	No action required
2	Other than the above			<p>(1) Check the station module in which the timeout occurred, and the cabling of the station modules around the affected module.</p> <p>(2) If the termination resistor is incorrect, if the termination resistor and cabling are loose, if a cable is being used that is of a length longer than that described in the specifications, or some other problem is present, a station module other than the cause of the failure might have timed out. If a timeout occurs even after the checks in (1), check the looseness of the cabling of the termination resistor and all station modules, as well as the cable length.</p> <p>(3) Replace the station module in the location for which the timeout occurred.</p>

ON: Normal communication

13. Troubleshooting

Troubleshooting from the remote I/O optical adapter

When an intermittent failure (timeout) occurs in a configuration where a remote I/O optical adapter is being used, identify the failed location by using the location in which the timeout occurred.

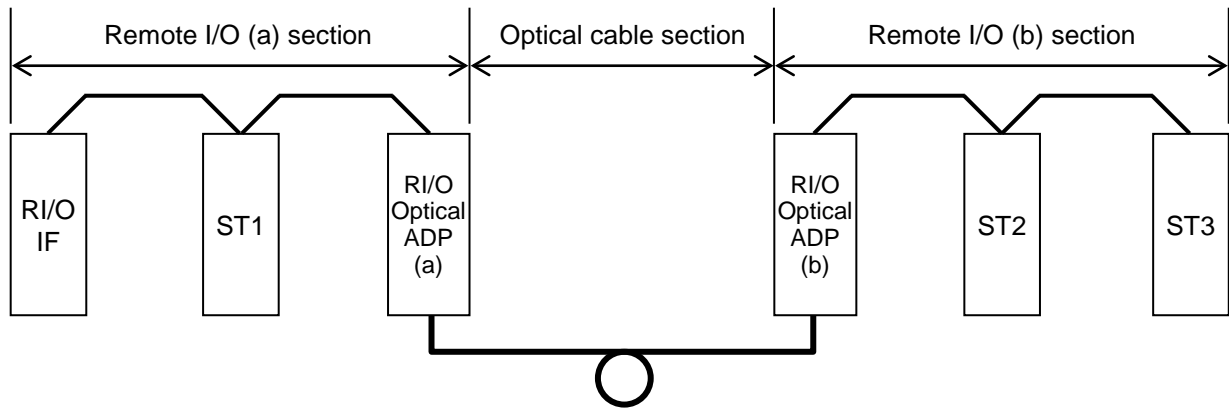

ST1 to ST3: Remote I/O station modules
 RI/O optical ADP (a), (b): Remote I/O optical adapter

Figure 13-26 Example remote I/O optical adapter failure location

Table 13-39 Failure analysis when a failure occurs intermittently 2

No.	Timeout location of occurrence			Corrective action
	ST1	ST2	ST3	
1	ON	ON	ON	No action required
2	Other than the above			(1) Check the station module in which the timeout occurred, and the cabling of the station modules around the affected module. (2) If an error exists in the CPU module settings, if the termination resistor is incorrect, if the termination resistor and cabling are loose, if a cable is being used that is of a length longer than that described in the specifications, or some other problem is present, a station module other than the cause of the failure might have timed out. If a timeout occurs even after the checks in (1), check the following: whether the CPU module settings are specified so that the remote I/O optical adapter is used, the termination resistor between the remote I/O (a) section and the remote I/O (b) section, the looseness of cabling between all of the station modules and the remote I/O optical adapter, the length of the remote I/O cable and the optical cable (the total length of the remote I/O cable), and other locations. (3) Replace the station module in the location for which the timeout occurred. (4) Replace both of the remote I/O optical adapters (the remote I/O optical adapters nearest the RI/O-IF module) connected to the station module in which the timeout occurred (both RI/O optical adapter (a) and RI/O optical adapter (b), if the timeout occurred in ST2 as shown in Figure 13-26).

ON: Normal communication

13.2.3.3 System register

Table 13-40 shows the system register addresses used to check the remote I/O line status of the RI/O-IF module.

Table 13-40 Register used to check the remote I/O line status

No.	Station allocation address	System register address	
		Registered station	Timeout station
1	XW0000/YW0000	S0300	S0380
2	XW0010/YW0010	S0301	S0381
3	XW0020/YW0020	S0302	S0382
4	XW0030/YW0030	S0303	S0383
5	XW0040/YW0040	S0304	S0384
6	XW0050/YW0050	S0305	S0385
⋮	⋮	⋮	⋮
123	XW07A0/YW07A0	S037A	S03FA
124	XW07B0/YW07B0	S037B	S03FB
125	XW07C0/YW07C0	S037C	S03FC
126	XW07D0/YW07D0	S037D	S03FD
127	XW07E0/YW07E0	S037E	S03FE
128	XW07F0/YW07F0	S037F	S03FF

13. Troubleshooting

System register details

Table 13-41 shows the details for the values of the registered station and timeout station.

Table 13-41 System register details

No.	System register values		Status	Status description
	Registered station	Timeout station		
1	1	0	Normal communication in progress	Remote I/O communication is being performed normally between the RI/O-IF module and the station module.
2	0	0	Timeout (no station registration)	Remote I/O communication was not performed normally even once between the RI/O-IF module and the station module. Even when the station module is connected, normal communication might not be possible for reasons such as incorrect settings or cabling errors.
3	1	1	Timeout (station registration)	Remote I/O communication was performed normally once between the RI/O-IF module and the station module, but currently a timeout has occurred. Normal communication might not be possible for reasons such as an incorrect termination resistor value or loose cables.

13.2.3.4 Relationship between the system configuration and system register

This section explains the status of the system register by using as examples both normal communication and a state where cables are disconnected, with respect remote I/O communication in the configuration shown in Figure 13-27.

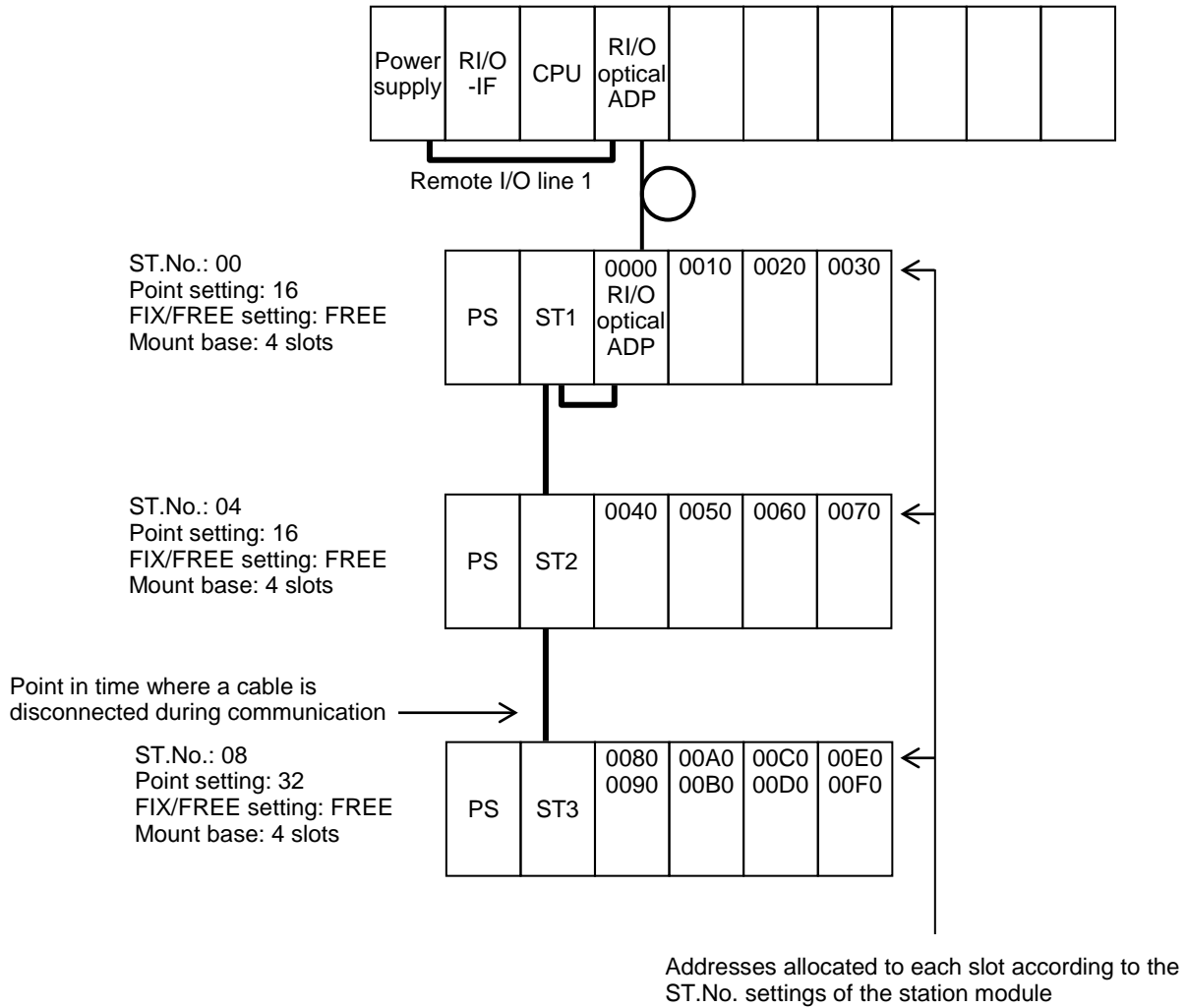

Figure 13-27 Example system configuration

Table 13-42 System register

ST.No. settings	Address allocated to station	System register addresses		System register values during normal communication		System register values when a cable is disconnected	
		Registered station	Timeout station	Registered station	Timeout station	Registered station	Timeout station
00	XW0000/YW0000	S0300	S0380	1	0	1	0
	XW0010/YW0010	S0301	S0381	1	0	1	0
	XW0020/YW0020	S0302	S0382	1	0	1	0
	XW0030/YW0030	S0303	S0383	1	0	1	0
04	XW0040/YW0040	S0304	S0384	1	0	1	0
	XW0050/YW0050	S0305	S0385	1	0	1	0
	XW0060/YW0060	S0306	S0386	1	0	1	0
	XW0070/YW0070	S0307	S0387	1	0	1	0
08	XW0080 to 0090/ YW0080 to 0090	S0308	S0388	1	0	1	1
		S0309	S0389	1	0	1	1
	XW00A0 to 00B0/ YW00A0 to 00B0	S030A	S038A	1	0	1	1
		S030B	S038B	1	0	1	1
	XW00C0 to 00D0/ YW00C0 to 00D0	S030C	S038C	1	0	1	1
		S030D	S038D	1	0	1	1
XW00E0 to 00F0/ YW00E0 to 00F0	S030E	S038E	1	0	1	1	
	S030F	S038F	1	0	1	1	
--	XW0100/YW0100	S0310	S0390	0	0	0	0
	?	?	?	?	?	?	?
	XW07F0/YW07F0	S037F	S03FF	0	0	0	0

The status of the system register for the area to which addresses are allocated in the ST.No. settings is that normal communication is in progress.
 The status of other areas is that a timeout has occurred (without station registration).

If a cable is disconnected during communication, the status of the stations beginning from the point at which the cable was removed changes from communicating normally to a timeout.
 The status of the ST.No.: 08 system register is that of a timeout occurring (with station registration).

13.2.4 PI/O module troubleshooting

This section describes how to perform PI/O module troubleshooting.

13.2.4.1 Analog module troubleshooting

Perform analog module troubleshooting according to Table 13-43 and Table 13-44.

Table 13-43 Analog input module troubleshooting

Operational error	Check	Corrective action
Input data cannot be correctly acquired.	Are there any problems with the analog input installation?	Correct the installation.
	Are there any mistakes in the terminal block installation?	Correctly install the terminal block.
	Are there any problems in the input cabling?	Correct the cabling.
	Are there any mistakes in the grounding?	Correctly ground the system.
	When mode 1 is specified, is the analog module registered in the CPU module?	Use the tools to register the analog module specified for mode 1.
	Is the range of input data being exceeded?	Use the correct range of input data.
Errors other than the above	Does the error persist, even after the above corrective action has been taken?	Replace the relevant module.

Table 13-44 Analog output module troubleshooting

Operational error	Check	Corrective action
The correct electrical voltage and current are not output.	Are there any problems with the analog output installation?	Correct the installation.
	Are there any mistakes in the terminal block installation?	Correctly install the terminal block.
	Are there any problems in the output cabling?	Correct the cabling.
	Are there any mistakes in the grounding?	Correctly ground the system.
	Are there any mistakes in the output channel?	Output data to the correct channel.
	When mode 1 is specified, is the analog module registered in the CPU module?	Use the tools to register the analog module specified for mode 1.
	Is the RANGE switch set incorrectly?	Set the switch correctly.
Errors other than the above	Does the error persist, even after the above corrective action has been taken?	Replace the relevant module.

13.2.4.2 Digital module troubleshooting

Perform digital module troubleshooting according to Table 13-45.

Table 13-45 Digital input module troubleshooting

Operational error	Check	Corrective action
No input points are ON.	Are there any mistakes in the terminal block installation?	Correctly install the terminal block.
	Are the screws used to install the module loose?	Tighten the screws used to install the module.
	Have you forgotten to supply the externally input power?	Supply the power.
	Is the externally supplied electrical voltage too low?	Raise the voltage.
	Is the internally supplied electrical voltage too low? (Voltage check terminal of the power module)	Replace the power module.
	Are there any problems in the external cabling?	Correct the cabling.
Only a particular input point is not ON.	Is the terminal block (connector) loose?	Correctly install the terminal block.
	Is the terminal block (connector) broken?	Replace the terminal block.
	Is the externally input ON time too fast?	Adjust the external device.
	Are any cables loose or disconnected?	Correct the cabling.
	Are there any problems with the I/O address of the program?	Correct the address.
No input points are OFF.	Are there any problems in the external cabling?	Correct the cabling.
	Is there an error in the external device?	Adjust the external device.
Input changes irregularly between ON and OFF.	Is the external input voltage too low?	Raise the external voltage.
	Have you taken corrective action with respect to noise?	Take corrective action to prevent noise, such as installing a surge absorber and separating the input cables.
Only a particular input point is not OFF.	Are there any problems in the external cabling?	Correct the cabling.
	Is there an error in the external device?	Adjust the external device.
Errors other than the above	Does the error persist, even after the above corrective action has been taken?	Replace the relevant module.

13.3 AutoSave procedure

When a failure occurs, use the AutoSave function of BASE SYSTEM/S10VE to save the data required to analyze the failure. The AutoSave procedure is as follows.

13.3.1 If the CPU module is connected to PADT

- (1) Set the CPU RUN/STOP switch of the CPU module to the STOP position.
- (2) Run AutoSave from PADT. For instructions on how to use AutoSave, see 8.4.6.10 *RAS menu: AutoSave*.

13.3.2 If the CPU module is not connected to PADT

- (1) When at ET connector of the CPU module is not in use
 - [1] Set the CPU RUN/STOP switch of the CPU module to the STOP position.
 - [2] From PADT, specify the IP address that is specified for an ET connector of the CPU module that is not in use. For details about how to specify this information, see 8.4.3.1 *Online menu: Change PCs*.
 - [3] Connect the CPU module to PADT by using an Ethernet cable.
 - [4] Run AutoSave from PADT. For details about running AutoSave, see 8.4.6.10 *RAS menu: AutoSave*.

- (2) When all ET connectors of the CPU module are in use
 - [1] Set the CPU RUN/STOP switch of the CPU module to the STOP position.
 - [2] Connect the CPU module to PADT within the same network, and then from PADT, specify the IP address that is specified for the connection port for connecting to the network. For details about how to specify this information, see 8.4.3.1 *Online menu: Change PCs*.
 - [3] Run AutoSave from PADT. For details about running AutoSave, see 8.4.6.10 *RAS menu: AutoSave*.

14. Adding and Replacing Modules

This chapter explains how to add modules to the SV10E system, and how to replace existing modules. Make sure that the new or replacement module is ready to install before starting the procedure. For details on how to dispose of modules you replaced, see *14.12 Disposal*.

14.1 Power supply module (LQV410)

This section explains how to replace the power supply module.

The replacement process involves removing the existing module and installing the new one. For details on these procedures, see *14.1.1* and *14.1.2* respectively.

WARNING

- To avoid electric shock, turn off the switch at the AC/DC power source (the MCCB or FFB, for example) before removing or installing a power supply module.
- To avoid electric shock, do not touch the pins on the power supply input terminal block.

Notice

- Take care to tighten the screws securely. Failing to do so can result in the system stopping or malfunctioning, or cause a module to fall.
- To avoid malfunction, make sure that each module is subjected to a run-in process before installation.

14.1.2 Installing a power supply module

- (1) Confirm that the power switch on the power supply module is off.
- (2) Confirm that the switch is off at the AC/DC power source (the MCCB or the FFB, for example).
- (3) Mount the power supply module to the mount base, and tighten the module fixing screws (M4) at the top and bottom of the power supply module (tightening torque: 1.0 N·m).
- (4) Connect the power supply wires to the terminal block of the power supply module.
- (5) Turn on the switch at the AC/DC power source (the MCCB or the FFB, for example).
- (6) Turn on the power switch of the power supply module.
- (7) Confirm that the POWER LED (green) on the front panel of the power supply module is on.
- (8) Use the output voltage check terminal of the power supply module to confirm that output is within $\pm 1.2\%$ of the rated voltage.

14.2 CPU module (LQP600)

This section explains how to replace the CPU module.

The replacement process involves removing the existing module and installing the new one. For details on these procedures, see *14.2.1.1* and *14.2.1.2* respectively.

14.2.1 Replacing the CPU module

Figure 14-2 shows the parts that are involved in the CPU module replacement process.

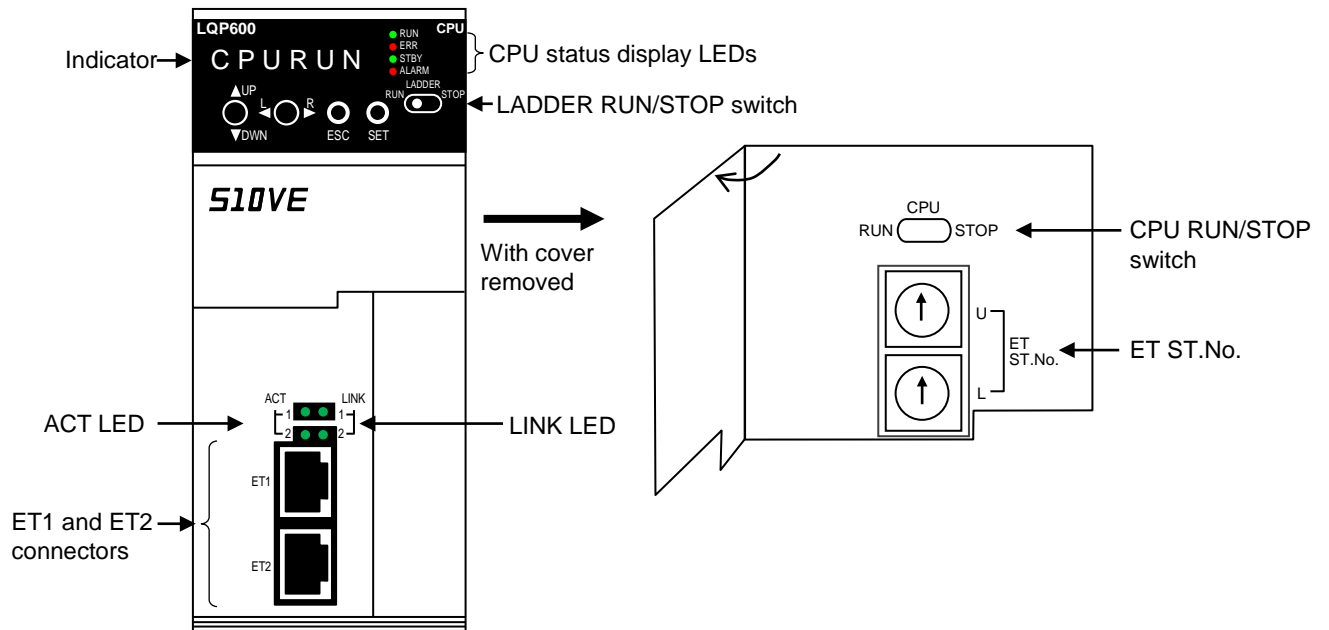

Figure 14-2 Parts involved in CPU module replacement process

14.2.1.1 Removing the CPU module

- (1) Slide the LADDER RUN/STOP switch from RUN to STOP, and confirm that LDRSTP appears on the indicator.
- (2) Slide the CPU RUN/STOP switch on the CPU module from RUN to STOP, and confirm that CPUSTP appears on the indicator.
- (3) Turn off the power switch on the power supply module.
- (4) Disconnect the Ethernet cables.
- (5) Loosen the module fixing screws(M4) at the top and bottom of the CPU module, and remove the CPU module from the mount base.

14.2.1.2 Installing a CPU module

- (1) Set the CPU RUN/STOP switch on the CPU module to STOP. Also set the LADDER RUN/STOP switch to STOP.
- (2) Confirm that the power switch on the power supply module is off.
- (3) Mount the CPU module to the mount base, and tighten the module fixing screws(M4) at the top and bottom of the CPU module(tightening torque: 1.0 N·m).
- (4) Connect the PADT Ethernet cable to ET1 or ET2 on the CPU module.
- (5) Turn on the power switch of the power supply module.
- (6) Restore the backup data to the CPU module(see 8.5.2 *Restore*).
- (7) Set the time(see 8.4.5.1 *Setting menu: Set Time*).
- (8) Turn off the power switch of the power supply module.
- (9) Disconnect the PADT, and reconnect the Ethernet cable(s) as they were prior to replacement.
- (10) Turn on the power switch of the power supply module.
- (11) Set the CPU RUN/STOP switch of the CPU module to RUN. Also, set the LADDER RUN/STOP switch to RUN.
- (12) Confirm that the RUN LED(green) is on, and that LDRRUN appears on the indicator.

14.2.2 Replacing the primary battery

 **WARNING**

- Do not allow the primary battery to be swallowed. Keep the battery out of reach of infants and children. If the primary battery is inadvertently swallowed, immediately consult a physician.
- Do not attempt to charge the primary battery. Attempting to charge the battery can result in gas generation or internal shorting, causing such issues as deformation, leakage, heat generation, explosion, or fire.
- Do not heat the primary battery. If the battery is heated to a temperature of 100°C or higher, the internal pressure of the battery rises, causing such issues as deformation, leakage, heat generation, explosion, or fire.
- Do not place the primary battery in a fire. If you do so, the metallic lithium will melt, causing the battery to explode or catch fire.
- Do not disassemble or bend the primary battery. Doing so can damage the insulating material, internal structure, or other aspect of the battery, causing such issues as deformation, leakage, heat generation, explosion, or fire.
- Take care not to insert the primary battery in the device upside down. Doing so can cause an abnormal reaction such as charging or shorting of the battery, which can lead to issues like deformation, leakage, heat generation, explosion, or fire.
- Do not allow a wire or other metallic object to contact the plus and minus terminals of the primary battery. Also, do not store or carry the battery with a necklace, hairpin, or other metal object that might cause such a connection to occur. Do not remove multiple batteries from their packaging and store them stacked together. If the primary battery shorts out, a significant overcurrent might flow, causing such issues as deformation, leakage, heat generation, explosion, or fire.
- Do not directly solder terminals or wires to the primary battery. The applied temperature can damage the insulation or internal structure of the battery, causing such issues as deformation, leakage, heat generation, explosion, or fire.
- Do not touch any liquid that has leaked from the primary battery. If the liquid contacts your eyes, it can cause eye damage. If such contact occurs, flush your eyes thoroughly with plenty of water from the faucet or another clean source, and immediately seek medical treatment. Do not rub your eyes. If the liquid enters your mouth or adheres to your lips, gargle with plenty of water from the faucet or another clean source, and consult a physician.
- Keep any liquids associated with the primary battery away from fire. If the battery is bent, leaking liquid, or producing an unusual odor, the electrolytic solution that leaks from the battery has the potential to ignite. Remove the battery from any source of fire.
- Do not keep the primary battery in prolonged contact with skin. Skin damage might result if tape or other means is used to achieve prolonged skin contact.
- Do not use primary batteries other than those specified by Hitachi. Use of other primary batteries can cause abnormal current to flow, causing damage to the primary battery or CPU module, or resulting in heat generation, smoke, explosion, or fire.

WARNING

- Shorting the battery terminals is dangerous even for a drained battery. A short circuit might occur if contact is made between the plus and minus terminals, or the battery contacts a piece of metal. When disposing of primary batteries, use insulating tape to wrap each battery as shown in the following example. Having done so, dispose of the battery as industrial waste.

Example of battery insulation:

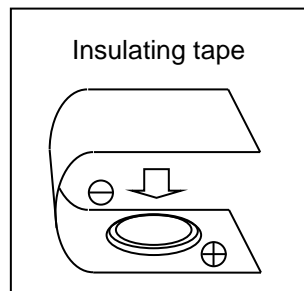
**CAUTION**

- Do not allow ultrasonic wave vibration near the primary battery. Ultrasonic wave vibration can pulverize its contents, causing an internal short. This can lead to issues as deformation, leakage, heat generation, explosion, or fire.
- Do not handle the primary battery roughly. Do not drop the battery, subject it to shock, or cause it to deform. This can cause deformation, leakage, heat generation, explosion, or fire.
- Take care to avoid shorting the primary battery when inserting it into the device. Some devices might have metal parts near where the battery is inserted, which can come into contact with the plus and minus terminal of the battery.
- Do not use or leave the primary battery in direct sunlight, in a hot car, or any other location that experiences high temperatures. This can cause deformation, leakage, heat generation, explosion, or fire.
- Do not allow the primary battery to get wet. This can cause deformation, leakage, heat generation, explosion, or fire. It can also cause the battery to rust.
- Do not store the primary battery anywhere hot or humid. Doing so can reduce the performance or service life of the battery. In some circumstances, it can also cause deformation, leakage, heat generation, or explosion.

Notice

- After replacing the primary battery, set the system time again.

14.2.2.1 Replacing the primary battery

This section explains how to replace the primary battery in the CPU module.

Make sure that you have a new primary battery on hand before beginning this process.

- (1) Remove the CPU module by following the procedure in *14.2.1.1 Removing the CPU module*.
- (2) Pull the tab on the primary battery cover on the left side panel of the CPU module, and remove the cover gently taking care not to catch on the battery cables.
- (3) Disconnect the battery cables from the primary battery connector on the CPU module.
- (4) Securely connect the new battery cables to the primary battery connector, using the color markings on the circuit board of the CPU module as a guide.
- (5) Insert the catch of the primary battery cover into the slot on the CPU module.
- (6) Press down on the primary battery cover until you hear it click into place.
- (7) Re-install the CPU module by following the procedure in *14.2.1.2 Installing a CPU module*. Note that because you do not need to restore backup data in this situation, you can skip step (6).

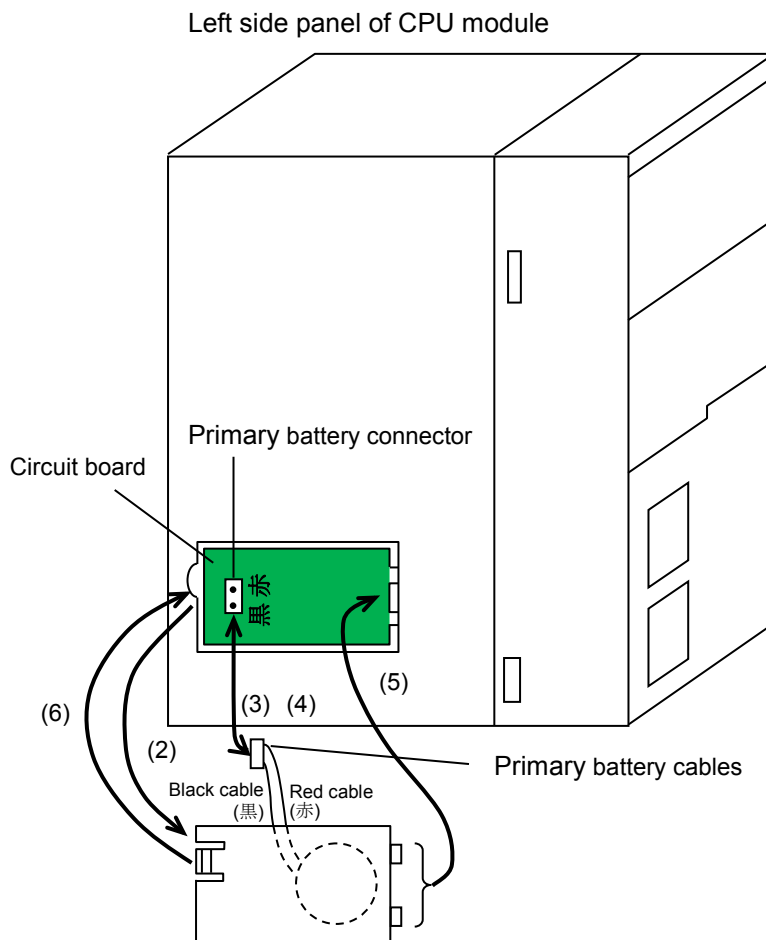

Figure 14-3 Diagram of primary battery replacement

 **WARNING**

- Do not put the primary battery cables between the primary battery cover and the CPU module. Doing so might result in shorting due to disconnection, causing deformation, leakage, heat generation, explosion, or fire.

14.3 RI/O-IF module (LQE950)

This section explains how to replace the RI/O-IF module.

The replacement process involves removing the existing module and installing the new one. For details on these procedures, see 14.3.1 and 14.3.2 respectively.

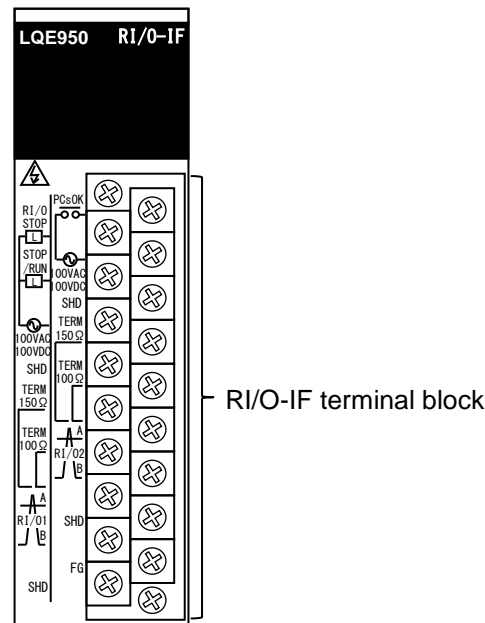

Figure 14-4 Parts involved in RI/O-IF module replacement process

14.3.1 Removing the RI/O-IF module

- (1) Slide the LADDER RUN/STOP switch on the CPU module from RUN to STOP, and confirm that LDRSTP appears on the indicator.
- (2) Slide the CPU RUN/STOP switch on the CPU module from RUN to STOP, and confirm that CPUSTP appears on the indicator.
- (3) Turn off the power switch of the power supply module.
- (4) Make a note of the cable connections to the terminal block of the RI/O-IF module. This is so you can reconnect the cables correctly later.
- (5) Disconnect the remote I/O cables from the terminal block of the RI/O-IF module.
- (6) Loosen the module fixing screws(M4) at the top and bottom of the RI/O-IF module, and remove the RI/O-IF module from the mount base.

14.3.2 Installing a RI/O-IF module

- (1) Confirm that the power switch on the power supply module is off.
- (2) Mount the RI/O-IF module to the mount base, and tighten the module fixing screws(M4) at the top and bottom of the RI/O-IF module(tightening torque: 1.0 N·m).
- (3) Connect the remote I/O cables to the same terminals on the terminal block of the RI/O-IF module as on the module you replaced.
- (4) Turn on the power switch of the power supply module.
- (5) Set the CPU RUN/STOP switch of the CPU module to RUN. Also set the LADDER RUN/STOP switch to RUN.
- (6) Confirm that the RUN LED(green) is on, and that LDRRUN appears on the indicator.

14.4 OD.RING module (LQE510-E)

This section explains how to replace an OD.RING module or add a new OD.RING module to the system.

Replacing a module involves removing the existing module and then installing a new one. For details on these procedures, see *14.4.1* and *14.4.2* respectively.

OD.RING module parameters are registered in the CPU module. Therefore, no parameter setting is required when replacing the module.

14.4.1 Removing the OD.RING module

- (1) Make a note of the information displayed on the indicator of the CPU module, and whether each of its LEDs(RUN, ALARM, STBY, ERR) is on, off, or blinking. Similarly, make a note of the state of the LEDs on the OD.RING module.
- (2) Slide the LADDER RUN/STOP switch on the CPU module from RUN to STOP, and confirm that LDRSTP appears on the indicator.
- (3) Use the RAS menu in BASE SYSTEM/S10VE to save the CP and HP error log information for the CPU module. For details on how to save this information, see *8.4.6.2 RAS menu: Error Log Display*.
- (4) Make a note of the state of the MODU No. and CPL No. setting switches on the OD.RING module.
- (5) Slide the CPU RUN/STOP switch on the CPU module from RUN to STOP, and confirm that CPUSTP appears on the indicator.
- (6) Turn off the power switch of the power supply module.
- (7) Make a note of the cable connections to the connectors on the OD.RING module. This is so you can reconnect the cables correctly later.
- (8) Disconnect any optical fiber cables connected to the OD.RING module. To protect against dust and dirt, cover the ends of the optical fiber cables and the connectors on the OD.RING module with dust-proof caps.
- (9) Loosen the module fixing screws(M4) at the top and bottom of the OD.RING module, and remove the OD.RING module from the mount base.

WARNING

- To avoid accident or electric shock, turn off the power switch on the power supply module before removing or installing a module.

Notice

- Static electricity might damage a module or cause it to malfunction. Discharge any static electricity from your body before touching the equipment.
- If you disconnect optical fiber cables from multiple modules at once, communication might be interrupted. Replace one module at a time.
- If you disconnect an optical fiber cable to replace a module while the ring is broken, communication will no longer be possible. Before replacing a module, look up the module RAS table and make sure that the ring is not broken.
- During module replacement, a disconnection will be detected and shown in the RAS table. However, communication will still take place as normal between the OD.RING modules in other units.

14.4.2 Installing an OD.RING module

- (1) Confirm that the power switch on the power supply module is off.
- (2) Mount the OD.RING module in the mount base, and tighten the module fixing screws(M4) at the top and bottom of the OD.RING module(tightening torque: 1.0 N·m).
- (3) Set the MODU No. and CPL No. setting switches on the OD.RING module to the same settings as on the module you replaced.
- (4) Remove the dust-proof caps attached to the optical fiber cables and the connectors of the OD.RING module, and clean the connectors. Then, connect the optical fiber cables to the same connectors on the OD.RING module as on the module you replaced.
- (5) Perform optical power measurement. For details on how to measure optical power, see 6.5 *Measuring optical power levels* in the *S10VE User's Manual Option OD.RING (LQE510-E)* (manual number SEE-1-101).
- (6) Turn on the power switch of the power supply module.
- (7) Set the CPU RUN/STOP switch of the CPU module to RUN. Also set the LADDER RUN/STOP switch to RUN.
- (8) Confirm that the state of the LEDs on the OD.RING module is as follows:
 - TX LED: Blinking
 - RX LED: Blinking
 - ERR LED: Off

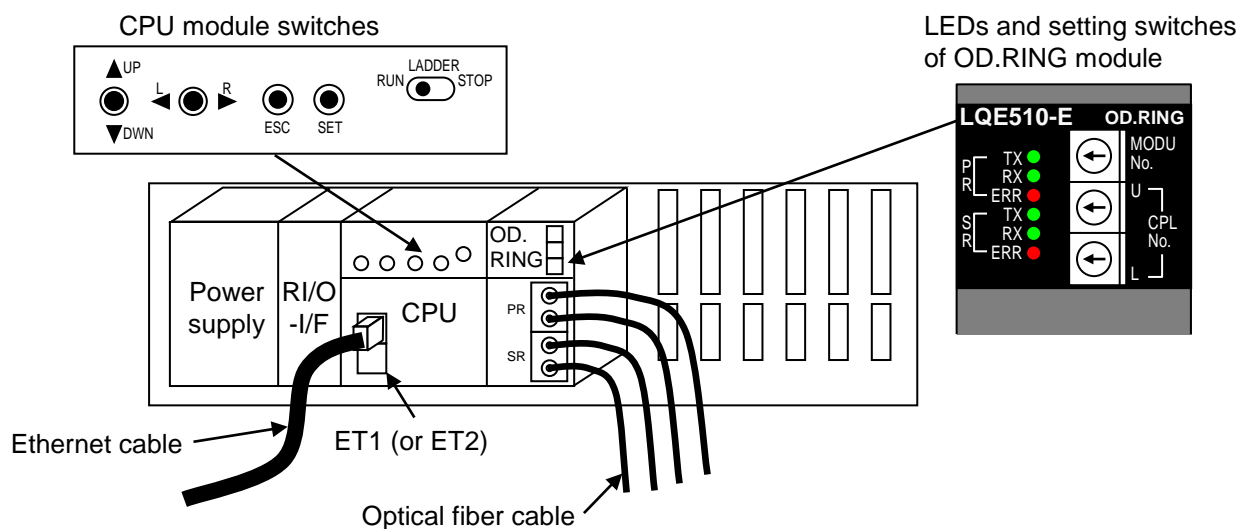

Figure 14-5 Parts involved in replacement or addition of OD.RING module

14.4.3 Adding an OD.RING module

- (1) Make a note of the information displayed on the indicator of the CPU module, and whether each of its LEDs(RUN, ALARM, STBY, ERR) is on, off, or blinking.
- (2) Slide the LADDER RUN/STOP switch on the CPU module from RUN to STOP, and confirm that LDRSTP appears on the indicator.
- (3) Use the RAS menu in BASE SYSTEM/S10VE to save the CP and HP error log information for the CPU module. For details on how to save this information, see *8.4.6.2 RAS menu: Error Log Display*.
- (4) Slide the CPU RUN/STOP switch on the CPU module from RUN to STOP, and confirm that CPUSTP appears on the indicator.
- (5) Turn off the power switch of the power supply module.
- (6) Mount the OD.RING module to the mount base, and tighten the module fixing screws(M4) at the top and bottom of the OD.RING module(tightening torque: 1.0 N·m).
- (7) Set the MODU No. and CPL No. setting switches on the OD.RING module. For details on how to set these switches, see the *S10VE User's Manual Option OD.RING (LQE510-E)* (manual number SEE-1-101). Make sure that the setting of the MODU No. setting switch does not conflict with those of other OD.RING modules.
- (8) Turn on the power switch of the power supply module.
- (9) Set the CPU RUN/STOP switch of the CPU module to RUN.
- (10) Start BASE SYSTEM/S10VE, and set up the OD.RING module you added. For details on how to set up a new OD.RING module, see the *S10VE User's Manual Option OD.RING (LQE510-E)* (manual number SEE-1-101).
- (11) Turn off the power switch of the power supply module.
- (12) Remove the dust-proof caps attached to the optical fiber cables and the connectors of the OD.RING module, and clean the connectors. Then, connect the optical fiber cables to the connectors on the OD.RING module.
- (13) Perform optical power measurement. For details on how to measure optical power, see *6.5 Measuring optical power levels* in the *S10VE User's Manual Option OD.RING (LQE510-E)* (manual number SEE-1-101).
- (14) Turn on the power switch of the power supply module.
- (15) Set the LADDER RUN/STOP switch on the CPU module to RUN.
- (16) Confirm that the state of the LEDs on the OD.RING module is as follows:
 - TX LED: Blinking
 - RX LED: Blinking
 - ERR LED: Off
- (17) Back up the data on the PCs. For details on how to back up the data on the PCs, see *14.11.1 Backup procedure*.

14.5 J.NET module (LQE540-E)

This section explains how to replace a J.NET module or add a new J.NET module to the system.

Replacing a module involves removing the existing module and then installing the new one. For details on these procedures, see *14.5.1* and *14.5.2* respectively.

J.NET module parameters are registered in the CPU module. Therefore, no parameter setting is required when replacing the module.

14.5.1 Removing the J.NET module

- (1) Make a note of the information displayed on the indicator of the CPU module, and whether each of its LEDs(RUN, ALARM, STBY, ERR) is on, off, or blinking. Similarly, make a note of the state of the LEDs on the J.NET module.
- (2) Slide the LADDER RUN/STOP switch on the CPU module from RUN to STOP, and confirm that LDRSTP appears on the indicator.
- (3) Use the RAS menu in BASE SYSTEM/S10VE to save the CP and HP error log information for the CPU module. For details on how to save this information, see *8.4.6.2 RAS menu: Error Log Display*.
- (4) Make a note of the state of the MODU No. and BIT RATE setting switches on the J.NET module.
- (5) Slide the CPU RUN/STOP switch on the CPU module from RUN to STOP, and confirm that CPUSTP appears on the indicator.
- (6) Turn off the power switch of the power supply module.
- (7) Make a note of the cable connections to the terminal block on the J.NET module. This is so you can reconnect the cables correctly later.
- (8) Disconnect any cables connected to the terminal block on the J.NET module.
- (9) Loosen the module fixing screws(M4) at the top and bottom of the J.NET module, and remove the J.NET module from the mount base.

WARNING

- To avoid accident or electric shock, turn off the power switch on the power supply module before removing or installing a module.

Notice

- Static electricity might damage a module or cause it to malfunction. Discharge any static electricity from your body before touching the equipment.

14.5.2 Installing a J.NET module

- (1) Confirm that the power switch on the power supply module is off.
- (2) Mount the J.NET module to the mount base, and tighten the module fixing screws(M4) at the top and bottom of the J.NET module(tightening torque: 1.0 N·m).
- (3) Set the MODU No. and BIT RATE setting switches on the J.NET module to the same settings as on the module you replaced.
- (4) Reconnect the cables you disconnected in step (8) in 14.5.1 to the same connectors.
- (5) Turn on the power switch of the power supply module.
- (6) Set the CPU RUN/STOP switch of the CPU module to RUN. Also set the LADDER RUN/STOP switch to RUN.
- (7) Confirm that the state of the LEDs on the J.NET module is as follows:

TX LED: Blinking

RX LED: Blinking

ERR LED: Off

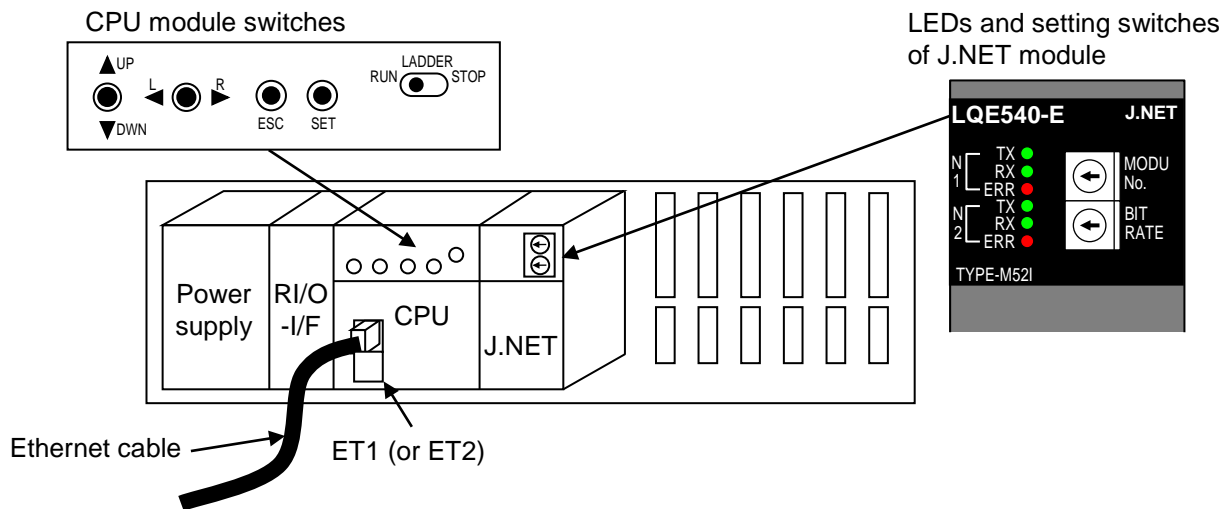

Figure 14-6 Parts involved in replacement or addition of J.NET module

14.5.3 Adding a J.NET module

- (1) Make a note of the information displayed on the indicator of the CPU module, and whether each of its LEDs(RUN, ALARM, STBY, ERR) is on, off, or blinking.
- (2) Slide the LADDER RUN/STOP switch on the CPU module from RUN to STOP, and confirm that LDRSTP appears on the indicator.
- (3) Use the RAS menu in BASE SYSTEM/S10VE to save the CP and HP error log information for the CPU module. For details on how to save this information, see *8.4.6.2 RAS menu: Error Log Display*.
- (4) Slide the CPU RUN/STOP switch on the CPU module from RUN to STOP, and confirm that CPUSTP appears on the indicator.
- (5) Turn off the power switch of the power supply module.
- (6) Mount the J.NET module to the mount base, and tighten the module fixing screws(M4) at the top and bottom of the J.NET module(tightening torque: 1.0 N·m).
- (7) Set the MODU No. and BIT RATE setting switches on the J.NET module. For details on how to set these switches, see the *S10VE User's Manual Option J.NET (LQE540-E)* (manual number SEE-1-102). Make sure that the setting of the MODU No. setting switch does not conflict with those of other J.NET modules.
- (8) Turn on the power switch of the power supply module.
- (9) Set the CPU RUN/STOP switch of the CPU module to RUN.
- (10) Start BASE SYSTEM/S10VE, and set up the J.NET module you added. For details on how to set up a new J.NET module, see *S10VE User's Manual Option J.NET (LQE540-E)* (manual number SEE-1-102).
- (11) Turn off the power switch of the power supply module.
- (12) Connect the cables to the terminal block of the J.NET module.
- (13) Turn on the power switch of the power supply module.
- (14) Set the LADDER RUN/STOP switch on the CPU module to RUN.
- (15) Confirm that the state of the LEDs on the J.NET module is as follows:
 - TX LED: Blinking
 - RX LED: Blinking
 - ERR LED: Off
- (16) Back up the data on the PCs. For details on how to back up the data on the PCs, see *14.11.1 Backup procedure*.

14.6 D.NET module (LQE770-E)

This section explains how to replace a D.NET module or add a new D.NET module to the system.

Replacing a module involves removing the existing module and then installing the new one. For details on these procedures, see *14.6.1* and *14.6.2* respectively.

D.NET module parameters are registered in the CPU module. Therefore, no parameter setting is required when replacing the module.

14.6.1 Removing the D.NET module

- (1) Make a note of the information displayed on the indicator of the CPU module, and whether each of its LEDs(RUN, ALARM, STBY, ERR) is on, off, or blinking. Similarly, make a note of the state of the LEDs on the D.NET module.
- (2) Slide the LADDER RUN/STOP switch on the CPU module from RUN to STOP, and confirm that LDRSTP appears on the indicator.
- (3) Use the RAS menu in BASE SYSTEM/S10VE to save the CP and HP error log information for the CPU module. For details on how to save this information, see *8.4.6.2 RAS menu: Error Log Display*.
- (4) Make a note of the state of the MODU No. setting switch on the D.NET module.
- (5) Slide the CPU RUN/STOP switch on the CPU module from RUN to STOP, and confirm that CPUSTP appears on the indicator.
- (6) Turn off the power switch of the power supply module.
- (7) Make a note of the cable connections to the connectors on the D.NET module. This is so you can reconnect the cables correctly later.
- (8) Disconnect any cables connected to the D.NET module.
- (9) Loosen the module fixing screws(M4) at the top and bottom of the D.NET module, and remove the D.NET module from the mount base.

WARNING

- To avoid accident or electric shock, turn off the power switch on the power supply module before removing or installing a module.

Notice

- Static electricity might damage a module or cause it to malfunction. Discharge any static electricity from your body before touching the equipment.

14.6.2 Installing a D.NET module

- (1) Confirm that the power switch on the power supply module is off.
- (2) Mount the D.NET module to the mount base, and tighten the module fixing screws(M4) at the top and bottom of the D.NET module(tightening torque: 1.0 N·m).
- (3) Set the MODU No. setting switch on the D.NET module to the same setting as on the module you replaced.
- (4) Reconnect the cables you disconnected in step (8) in *14.6.1* to the same connectors.
- (5) Turn on the power switch of the power supply module.
- (6) Set the CPU RUN/STOP switch of the CPU module to RUN. Also set the LADDER RUN/STOP switch to RUN.
- (7) Confirm that the state of the LEDs on the D.NET module is as follows:
 MS LED: Lit green
 NS LED: Lit green

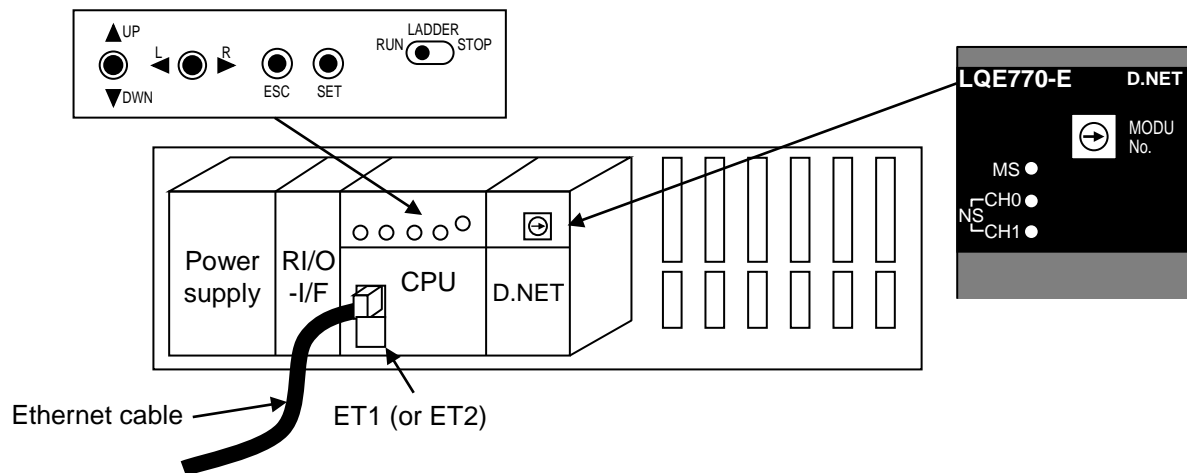

Figure 14-7 Parts involved in replacement or addition of D.NET module

14.6.3 Adding a D.NET module

- (1) Make a note of the information displayed on the indicator of the CPU module, and whether each of its LEDs(RUN, ALARM, STBY, ERR) is on, off, or blinking.
- (2) Slide the LADDER RUN/STOP switch on the CPU module from RUN to STOP, and confirm that LDRSTP appears on the indicator.
- (3) Use the RAS menu in BASE SYSTEM/S10VE to save the CP and HP error log information for the CPU module. For details on how to save this information, see *8.4.6.2 RAS menu: Error Log Display*.
- (4) Slide the CPU RUN/STOP switch on the CPU module from RUN to STOP, and confirm that CPUSTP appears on the indicator.
- (5) Turn off the power switch of the power supply module.
- (6) Mount the D.NET module to the mount base, and tighten the module fixing screws(M4) at the top and bottom of the D.NET module(tightening torque: 1.0 N·m).
- (7) Set the MODU No. setting switch on the D.NET module. For details on how to set this switch, see the *S10VE User's Manual Option D.NET (LQE770-E)* (manual number SEE-1-103). Make sure that the setting of the MODU No. setting switch does not conflict with those of other D.NET modules.
- (8) Turn on the power switch of the power supply module.
- (9) Set the CPU RUN/STOP switch of the CPU module to RUN.
- (10) Start BASE SYSTEM/S10VE, and set up the D.NET module you added. For details on how to set up a new D.NET module, see the *S10VE User's Manual Option D.NET (LQE770-E)* (manual number SEE-1-103).
- (11) Turn off the power switch of the power supply module.
- (12) Connect the cables to the connectors of the D.NET module.
- (13) Turn on the power switch of the power supply module.
- (14) Set the LADDER RUN/STOP switch on the CPU module to RUN.
- (15) Confirm that the state of the LEDs on the D.NET module is as follows:
 - MS LED: Lit green
 - NS LED: Lit green
- (16) Back up the data on the PCs. For details on how to back up the data on the PCs, see *14.11.1 Backup procedure*.

14.7 FL.NET module (LQE702-E)

This section explains how to replace an FL.NET module or add a new FL.NET module to the system.

Replacing a module involves removing the existing module and then installing the new one. For details on these procedures, see *14.7.1* and *14.7.2* respectively.

FL.NET module parameters are registered in the CPU module. Therefore, no parameter setting is required when replacing the module.

14.7.1 Removing the FL.NET module

- (1) Make a note of the information displayed on the indicator of the CPU module, and whether each of its LEDs (RUN, ALARM, STBY, ERR) is on, off, or blinking. Similarly, make a note of the state of the LEDs on the FL.NET module.
- (2) Slide the LADDER RUN/STOP switch on the CPU module from RUN to STOP, and confirm that LDRSTP appears on the indicator.
- (3) Use the RAS menu in BASE SYSTEM/S10VE to save the CP and HP error log information for the CPU module. For details on how to save this information, see *8.4.6.2 RAS menu: Error Log Display*.
- (4) Make a note of the state of the MAIN/SUB setting switch on the FL.NET module.
- (5) Slide the CPU RUN/STOP switch on the CPU module from RUN to STOP, and confirm that CPUSTP appears on the indicator.
- (6) Turn off the power switch of the power supply module.
- (7) Disconnect any cables connected to the FL.NET module.
- (8) Loosen the module fixing screws (M4) at the top and bottom of the FL.NET module, and remove the FL.NET module from the mount base.

WARNING

- To avoid accident or electric shock, turn off the power switch on the power supply module before removing or installing a module.

Notice

- Static electricity might damage a module or cause it to malfunction. Discharge any static electricity from your body before touching the equipment.

14.7.2 Installing an FL.NET module

- (1) Confirm that the power switch on the power supply module is off.
- (2) Mount the FL.NET module to the mount base, and tighten the module fixing screws(M4) at the top and bottom of the FL.NET module(tightening torque: 1.0 N·m).
- (3) Set the MAIN/SUB setting switch on the FL.NET module to the same setting as on the module you replaced.
- (4) Reconnect the cables you disconnected in step (7) in 14.7.1 to the connectors of the FL.NET module.
- (5) Set the CPU RUN/STOP switch of the CPU module to RUN. Also set the LADDER RUN/STOP switch to RUN.
- (6) Turn on the power switch of the power supply module.
- (7) Confirm that the state of the LEDs on the FL.NET module is as follows:

RUN LED: On

LER LED: On

ERR LED: Off

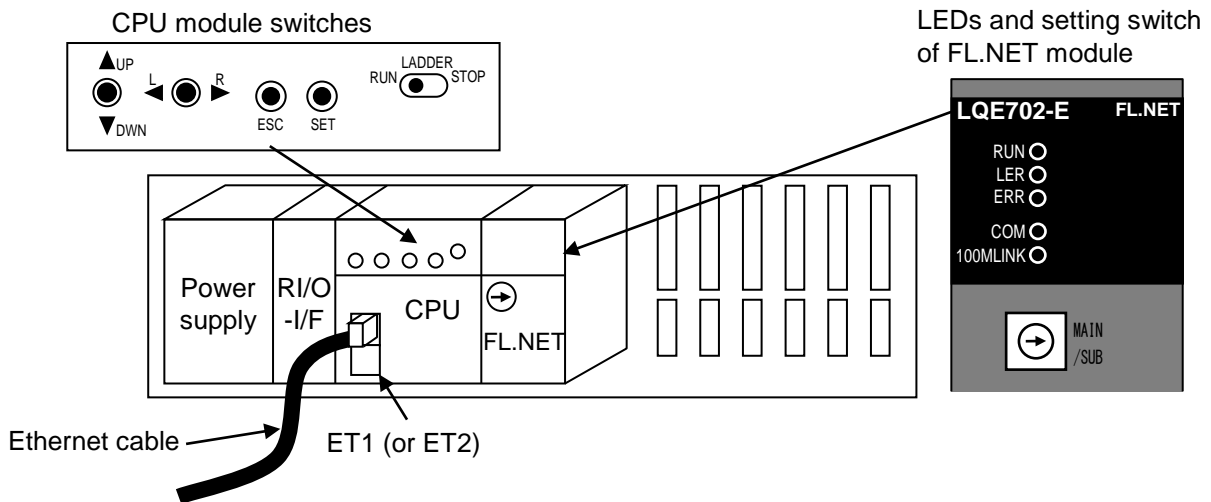

Figure 14-8 Parts involved in replacement or addition of FL.NET module

14.7.3 Adding an FL.NET module

- (1) Make a note of the information displayed on the indicator of the CPU module, and whether each of its LEDs(RUN, ALARM, STBY, ERR) is on, off, or blinking.
- (2) Slide the LADDER RUN/STOP switch on the CPU module from RUN to STOP, and confirm that LDRSTP appears on the indicator.
- (3) Use the RAS menu in BASE SYSTEM/S10VE to save the CP and HP error log information for the CPU module. For details on how to save this information, see *8.4.6.2 RAS menu: Error Log Display*.
- (4) Slide the CPU RUN/STOP switch on the CPU module from RUN to STOP, and confirm that CPUSTP appears on the indicator.
- (5) Turn off the power switch of the power supply module.
- (6) Mount the FL.NET module to the mount base, and tighten the module fixing screws(M4) at the top and bottom of the FL.NET module(tightening torque: 1.0 N·m).
- (7) Set the MAIN/SUB setting switch on the FL.NET module. For details on how to set this switch, see the *S10VE User's Manual Option FL.NET (LQE702-E)* (manual number SEE-1-104). Make sure that the setting of the MAIN/SUB setting switch does not conflict with those of other FL.NET modules.
- (8) Turn on the power switch of the power supply module.
- (9) Set the CPU RUN/STOP switch of the CPU module to RUN.
- (10) Start BASE SYSTEM/S10VE, and set up the FL.NET module you added. For details on how to set up a new FL.NET module, see the *S10VE User's Manual Option FL.NET (LQE702-E)* (manual number SEE-1-104).
- (11) Turn off the power switch of the power supply module.
- (12) Connect the cables to the connectors of the FL.NET module.
- (13) Turn on the power switch of the power supply module.
- (14) Set the LADDER RUN/STOP switch on the CPU module to RUN.
- (15) Confirm that the state of the LEDs on the FL.NET module is as follows:
RUN LED: On
LER LED: On
ERR LED: Off
- (16) Back up the data on the PCs. For details on how to back up the data on the PCs, see *14.11.1 Backup procedure*.

14.8 ET.NET module (LQE260-E)

This section explains how to replace an ET.NET module or add a new ET.NET module to the system.

Replacing a module involves removing the existing module and then installing the new one. For details on these procedures, see *14.8.1* and *14.8.2* respectively.

ET.NET module parameters are registered in the CPU module. Therefore, no parameter setting is required when replacing the module.

14.8.1 Removing the ET.NET module

- (1) Make a note of the information displayed on the indicator of the CPU module, and whether each of its LEDs(RUN, ALARM, STBY, ERR) is on, off, or blinking. Similarly, make a note of the state of the LEDs on the ET.NET module.
- (2) Slide the LADDER RUN/STOP switch on the CPU module from RUN to STOP, and confirm that LDRSTP appears on the indicator.
- (3) Use the RAS menu in BASE SYSTEM/S10VE to save the CP and HP error log information for the CPU module. For details on how to save this information, see *8.4.6.2 RAS menu: Error Log Display*.
- (4) Make a note of the state of the MAIN/SUB and ST No. setting switches on the ET.NET module.
- (5) Slide the CPU RUN/STOP switch on the CPU module from RUN to STOP, and confirm that CPUSTP appears on the indicator.
- (6) Turn off the power switch of the power supply module.
- (7) Make a note of the cable connections to the connectors on the ET.NET module. This is so you can reconnect the cables correctly later.
- (8) Disconnect any cables connected to the ET.NET module.
- (9) Loosen the module fixing screws(M4) at the top and bottom of the ET.NET module, and remove the ET.NET module from the mount base.

 WARNING
--

- | |
|---|
| <ul style="list-style-type: none">● To avoid accident or electric shock, turn off the power switch on the power supply module before removing or installing a module. |
|---|

Notice

- | |
|---|
| <ul style="list-style-type: none">● Static electricity might damage a module or cause it to malfunction. Discharge any static electricity from your body before touching the equipment. |
|---|

14.8.2 Installing an ET.NET module

- (1) Confirm that the power switch on the power supply module is off.
- (2) Mount the ET.NET module to the mount base, and tighten the module fixing screws(M4) at the top and bottom of the ET.NET module(tightening torque: 1.0 N·m).
- (3) Set the MAIN/SUB and ST No. setting switches of the ET.NET module to the same settings as on the module you replaced.
- (4) Reconnect the cables you disconnected in step (8) in 14.8.1 to the same connectors.
- (5) Turn on the power switch of the power supply module.
- (6) Set the CPU RUN/STOP switch of the CPU module to RUN. Also set the LADDER RUN/STOP switch to RUN.
- (7) Confirm that the state of the LEDs on the ET.NET module is as follows:
 RUN LED: On
 ALARM LED: Off
 ERR LED: Off
 TX/RX LED: On or blinking
 100M LED and 10M LED: One is on and the other off according to the link speed.

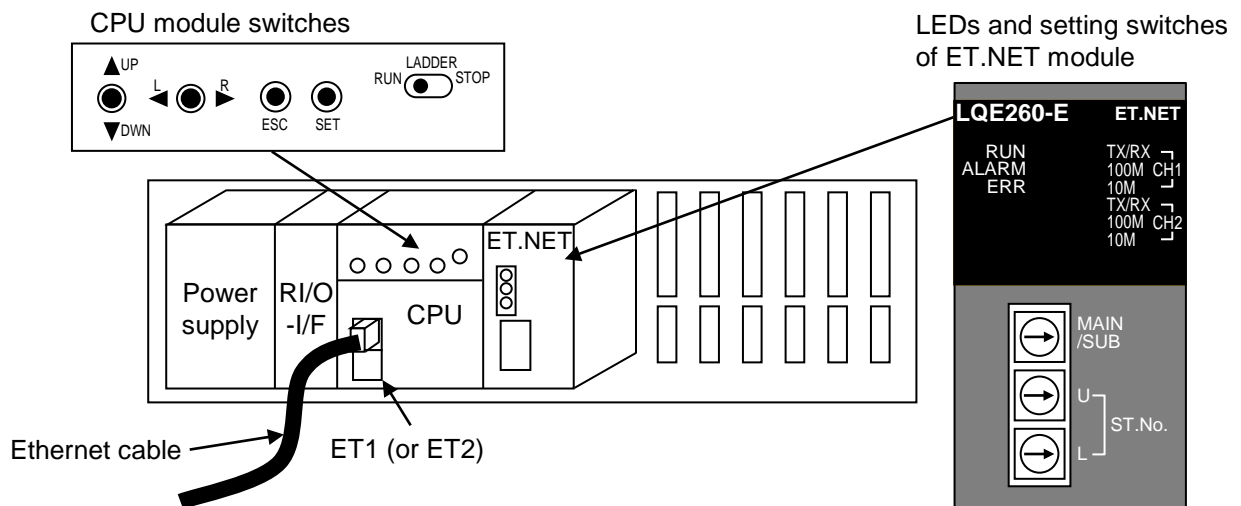

Figure 14-9 Parts involved in replacement or addition of ET.NET module

14.8.3 Adding an ET.NET module

- (1) Make a note of the information displayed on the indicator of the CPU module, and whether each of its LEDs(RUN, ALARM, STBY, ERR) is on, off, or blinking.
- (2) Slide the LADDER RUN/STOP switch on the CPU module from RUN to STOP, and confirm that LDRSTP appears on the indicator.
- (3) Use the RAS menu in BASE SYSTEM/S10VE to save the CP and HP error log information for the CPU module. For details on how to save this information, see *8.4.6.2 RAS menu: Error Log Display*.
- (4) Slide the CPU RUN/STOP switch on the CPU module from RUN to STOP, and confirm that CPUSTP appears on the indicator.
- (5) Turn off the power switch of the power supply module.
- (6) Mount the ET.NET module to the mount base, and tighten the module fixing screws(M4) at the top and bottom of the ET.NET module(tightening torque: 1.0 N·m).
- (7) Set the MAIN/SUB and ST No. setting switches on the ET.NET module. For details on how to set these switches, see the *S10VE User's Manual Option ET.NET (LQE260-E)* (manual number SEE-1-105). Make sure that the setting of the MAIN/SUB setting switch does not conflict with those of other ET.NET modules.
- (8) Turn on the power switch of the power supply module.
- (9) Set the CPU RUN/STOP switch of the CPU module to RUN.
- (10) Start BASE SYSTEM/S10VE, and set up the ET.NET module you added. For details on how to set up a new ET.NET module, see the *S10VE User's Manual Option ET.NET (LQE260-E)* (manual number SEE-1-105).
- (11) Turn off the power switch of the power supply module.
- (12) Connect the cable to the connector of the ET.NET module.
- (13) Turn on the power switch of the power supply module.
- (14) Set the LADDER RUN/STOP switch on the CPU module to RUN.
- (15) Confirm that the state of the LEDs on the ET.NET module is as follows:
 - RUN LED: On
 - ALARM LED: Off
 - ERR LED: Off
 - TX/RX LED: On or blinking
 - 100M LED and 10M LED: One is on and the other off according to the link speed.
- (16) Back up the data on the PCs. For details on how to back up the data on the PCs, see *14.11.1 Backup procedure*.

14.9 PI/O module

This section explains how to replace a PI/O module or add a new PI/O module to the system.

Replacing a module involves removing the existing module and then installing the new one. For details on these procedures, see *14.9.1* and *14.9.2* respectively.

14.9.1 Removing a PI/O module

- (1) Make a note of the information displayed on the indicator of the CPU module, and whether each of its LEDs (RUN, ALARM, STBY, ERR) is on, off, or blinking.
- (2) Slide the LADDER RUN/STOP switch on the CPU module from RUN to STOP, and confirm that LDRSTP appears on the indicator.
- (3) Use the RAS menu in BASE SYSTEM/S10VE to save the CP and HP error log information for the CPU module. For details on how to save this information, see *8.4.6.2 RAS menu: Error Log Display*.
- (4) If there are switches on the PI/O module, make a note of the state of the switches.
- (5) Slide the CPU RUN/STOP switch on the CPU module from RUN to STOP, and confirm that CPUSTP appears on the indicator.
- (6) Turn off the power switch of the power supply module.
- (7) Turn off the power supply on the facility side that is connected to the PI/O module.
- (8) Make a note of the cable connections to the connectors or terminal block on the PI/O module. This is so you can reconnect the cables correctly later.
- (9) Disconnect the cables from the terminal block or connectors on the PI/O module.
- (10) Loosen the module fixing screws (M4) at the top and bottom of the PI/O module, and remove the PI/O module from the mount base.

WARNING

- To avoid accident or electric shock, turn off the power switch on the power supply module before removing or installing a module.
- To avoid electric shock, turn off the power supply on the facility side that is connected to the PI/O module before removing or mounting the module.

Notice

- Static electricity might damage a module or cause it to malfunction. Discharge any static electricity from your body before touching the equipment.

14. Adding and Replacing Modules

14.9.2 Installing a PI/O module

- (1) Confirm that the power switch on the power supply module is off.
- (2) Mount the PI/O module to the mount base, and tighten the module fixing screws(M4) at the top and bottom of the PI/O module(tightening torque: 1.0 N·m).
- (3) If there are switches on the PI/O module, set them to the same state as on the module you replaced.
- (4) Reconnect the cables you disconnected in step (9) in *14.9.1* to the terminal block or connectors.
- (5) Turn on the facility-side power supply you turned off in step (7) in *14.9.1*.
- (6) Turn on the power switch of the power supply module.
- (7) Set the CPU RUN/STOP switch of the CPU module to RUN. Also set the LADDER RUN/STOP switch to RUN.
- (8) Confirm that the PI/O module is operating correctly.

14.9.3 Adding a PI/O module

- (1) Make a note of the information displayed on the indicator of the CPU module, and whether each of its LEDs(RUN, ALARM, STBY, ERR) is on, off, or blinking.
- (2) Slide the LADDER RUN/STOP switch on the CPU module from RUN to STOP, and confirm that LDRSTP appears on the indicator.
- (3) Use the RAS menu in BASE SYSTEM/S10VE to save the CP and HP error log information for the CPU module. For details on how to save this information, see *8.4.6.2 RAS menu: Error Log Display*.
- (4) Slide the CPU RUN/STOP switch on the CPU module from RUN to STOP, and confirm that CPUSTP appears on the indicator.
- (5) Turn off the power switch of the power supply module.
- (6) Mount the PI/O module to the mount base, and tighten the module fixing screws(M4) at the top and bottom of the PI/O module(tightening torque: 1.0 N·m).
- (7) Set any switches on the PI/O module. For details on how to set the switches, see *S10mini Hardware Manual I/O Modules* (manual number SME-1-114).
- (8) Turn on the power switch of the power supply module.
- (9) Set the CPU RUN/STOP switch of the CPU module to RUN.
- (10) Start BASE SYSTEM/S10VE, and set up the PI/O module you added. For details on how to set up a new PI/O module, see the *S10VE Software Manual Operation Ladder Diagram System for Windows®* (manual number SEE-3-131). Note that no setup is required for PI/O modules whose model number starts with LQX or LQY.
- (11) Turn off the power switch of the power supply module.
- (12) Connect the cables to the terminal block or connectors of the PI/O module.
- (13) Turn on the power supply on the facility side connected to the PI/O module.
- (14) Turn on the power switch of the power supply module.
- (15) On the CPU module, set the CPU RUN/STOP switch and the LADDER RUN/STOP switch to RUN.
- (16) Confirm that the PI/O module is operating normally.
- (17) Back up the data on the PCs. For details on how to back up the data on the PCs, see *14.11.1 Backup procedure*.

14.10 Remote I/O optical adapter module (LQZ410)

This section explains how to replace a remote I/O optical adapter module.

Replacing a module involves removing the existing module and then installing the new one. For details on these procedures, see *14.10.1* and *14.10.2* respectively.

14.10.1 Removing the remote I/O optical adapter module

- (1) Make a note of the information displayed on the indicator of the CPU module, and whether each of its LEDs (RUN, ALARM, STBY, ERR) is on, off, or blinking. Similarly, make a note of the state of the LEDs on the ET.NET module.
- (2) Slide the LADDER RUN/STOP switch on the CPU module from RUN to STOP, and confirm that LDRSTP appears on the indicator.
- (3) Use the RAS menu in BASE SYSTEM/S10VE to save the CP and HP error log information for the CPU module. For details on how to save this information, see *8.4.6.2 RAS menu: Error Log Display*.
- (4) Make a note of the state of the MODE setting switch on the remote I/O optical adapter module.
- (5) Slide the CPU RUN/STOP switch on the CPU module from RUN to STOP, and confirm that CPUSTP appears on the indicator.
- (6) Turn off the power switch of the power supply module.
- (7) Disconnect the optical fiber cable from the remote I/O optical adapter module. To protect against dust and dirt, cover the end of the optical fiber cable and the connector on the remote I/O optical adapter module with dust-proof caps.
- (8) Make a note of the cable connections to the terminal block of the remote I/O optical adapter module. This is so you can reconnect the cables correctly later.
- (9) Disconnect the remote I/O cables connected to the remote I/O optical adapter module.
- (10) Loosen the module fixing screws (M4) at the top and bottom of the remote I/O optical adapter module, and remove the remote I/O optical adapter module from the mount base.

WARNING

- To avoid accident or electric shock, turn off the power switch on the power supply module before removing or installing a module.

Notice

- Static electricity might damage a module or cause it to malfunction. Discharge any static electricity from your body before touching the equipment.

14.10.2 Installing a remote I/O optical adapter module

- (1) Confirm that the power switch on the power supply module is off.
- (2) Mount the remote I/O optical adapter module to the mount base, and tighten the module fixing screws(M4) at the top and bottom of the remote I/O optical adapter module(tightening torque: 1.0 N·m).
- (3) Set the MODE setting switch on the remote I/O optical adapter module to the same setting as on the module you replaced.
- (4) Remove the dust-proof caps attached to the optical fiber cables and the connectors of the remote I/O optical adapter module, and clean the connectors. Then, connect the optical fiber cables to the same connectors on the remote I/O optical adapter module as on the module you replaced.
- (5) Connect the remote I/O cables you removed in step (9) in *14.10.1* to the remote I/O optical adapter module.
- (6) Perform optical power measurement.
- (7) Turn on the power switch of the power supply module.
- (8) Set the CPU RUN/STOP switch of the CPU module to RUN. Also set the LADDER RUN/STOP switch to RUN.
- (9) Confirm that the state of the LEDs on the remote I/O optical adapter module is as follows:
 - OPT TX LED: On
 - OPT RX LED: On
 - RIO TX LED: On
 - RIO RX LED: On

14.11 Backup and restoration

To back up and restore data, you use the BACKUP RESTORE SYSTEM of BASE SYSTEM/S10VE.

14.11.1 Backup procedure

- (1) Turn off the power switch on the power supply module.
- (2) Use the ET ST.No. setting switches on the CPU module to set the Ethernet station number of the CPU module. For details on how to do so, see *Chapter 9. Settings*.
- (3) Use an Ethernet cable to connect the PADT to the CPU module.
- (4) Set the CPU RUN/STOP switch and LADDER RUN/STOP switch of the CPU module to STOP.
- (5) Turn on the power switch of the power supply module.
- (6) Back up the data on the CPU module by following the procedure in *8.5.1 Backup*.

14.11.2 Restoration procedure

- (1) Turn off the power switch on the power supply module.
- (2) Use the ET ST.No. setting switches on the CPU module to set the Ethernet station number of the CPU module. For details on how to do so, see *Chapter 9. Settings*.
- (3) Use an Ethernet cable to connect the PADT to the CPU module.
- (4) Set the CPU RUN/STOP switch and LADDER RUN/STOP switch of the CPU module to STOP.
- (5) Turn on the power switch of the power supply module.
- (6) Restore the backup data to the CPU module by following the procedure in *8.5.2 Restore*.

14.12 Disposal

Observe the following when disposing of S10VE modules and primary batteries:

Notice

- Each module uses components containing gallium arsenide (GaAs). Because gallium arsenide is legally defined as a hazardous substance, take particular care with its disposal. When disposing of a module, it must be disposed of as industrial waste by professionals.
- Dispose of primary batteries according to your local laws and regulations with the assistance of waste disposal professionals.

This page is intentionally left blank.

Appendix A. Hitachi Programmable Controller S10VE Repair Request

Fill in this request form and submit it to your sales representative.

Company name			Person in charge		
Date and time of occurrence	Year:		Month:	Day:	Hour: Minute:
Contact information	Address				
	TEL				
	FAX				
	E-mail				
Model number of defective module					
OS	Ver.	Rev.	Program name:	Ver.	Rev.
Support program			Program name:	Ver.	Rev.
Nature of defect					
Connected load(s)	Type of load				
	Model number(s)				
	Details of wiring				
System configuration and switch settings					
Notes					

(Continued on next page)

A. Hitachi Programmable Controller S10VE Repair Request

LED status

Module	Model number	LED	On	Blinking	Off	Module	Model number	LED	On	Blinking	Off
Power supply	LQV410	POWER				ET.NET	LQE260-E	RUN			
		OV						ALARM			
		OC						ERR			
CPU	LQP600	RUN						CH1 TX/RX			
		ERR						CH1 100M			
		STBY						CH1 10M			
		ALARM						CH2 TX/RX			
		ACT1						CH2 100M			
		ACT2						CH2 10M			
		LINK1									
		LINK2									
OD.RING	LQE510-E	PR TX									
		PR RX									
		PR ERR									
		SR TX									
		SR RX									
		SR ERR									
J.NET	LQE540-E	N1 TX									
		N1 RX									
		N1 ERR									
		N2 TX									
		N2 RX									
		N2 ERR									
D.NET	LQE770-E	MS									
		NS-CH0									
		NS-CH1									
FL.NET	LQE702-E	RUN									
		LER									
		ERR									
		COM									
		100MLINK									

#: When sending a product for repair, re-attach all connector caps that were attached upon initial delivery.

Make a note below of any other information you think might be relevant (e.g. what occurred in the lead-up to the issue, adverse weather such as lightning, and disruptions to mains power supply):

Appendix B. List of Error Codes

Table B-1 List of CPU module error codes (1/3)

No.	Information in BASE SYSTEM/S10VE error log		Indicator display	Reference for troubleshooting
	Error code	Error message		
1	03030000	System down (Inst. Alignment Error)	ECC=03030000	Table 13-3
2	03040000	System down (Illegal Instruction)	ECC=03040000	
3	030F0000	System down (Illegal Exception)	ECC=030F0000	
4	03380000	System down (FP Unavailable)	ECC=03380000	
5	03390000	System down (FP System down)	ECC=03390000	
6	03400000	System down (Instruction Page Fault)	ECC=03400000	
7	03470000	System down (Data Alignment Error)	ECC=03470000	
8	03600000	System down (Data Page Fault)	ECC=03600000	
9	03660000	System down (Data Access Protection)	ECC=03660000	
10	03E00000	Module Error (System task error(Table not found))	ECC=03E00000	
11	03E00001	Module Error (System task error(Task queue failed))	ECC=03E00001	
12	05700000	System down (System Error)	ECC=05700000	
13	05700001	System down (CP Infinit loop Detect)	ECC=05700001	
14	05700002	System down (HP Infinit loop Detect)	ECC=05700002	
15	05800000	System down (Kernel Trap)	ECC=05800000	
16	05900000	System down (CP Down)	ECC=05900000	
17	05C70000	WDT timeout error	ECC=05C70000	
18	03820000	System down (Memory Error)	ECC=03820000	
19		Memory Error		
20	03B60000	Module Error (Memory Error(MRAM))	ECC=03B60000	
21		System down (Memory Error(MRAM))		
22		Module Error (RI/O-IF Module Error)		
23		System down (RI/O-IF Module Error)		
24	03B80000	System down (R700/S10 Bus Error)	ECC=03B80000	
25	03B80001	System down (CPU Master)	ECC=03B80001	
26		System Bus Error (CPU Master)		
27	03B90000	Module Error (PCI Bus Error)	ECC=03B90000	
28		System down (PCI Bus Error)		
29	03BD0000	Module Error (LSI Internal Timeout Error)	ECC=03BD0000	
30		System down (LSI Internal Timeout Error)		
31	03BE0000	Module Error (SPU Error)	ECC=03BE0000	
32		System down (SPU Error)		
33	03BF0000	Module Error (RI/O Error)	ECC=03BF0000	
34		System down (RI/O Error)		
35	0500F001	System down (HERST Invalid Interrupt)	ECC=0500F001	
36	0500F003	System down (BUERRSTAT Invalid Interrupt)	ECC=0500F003	
37	0500F004	System down (P2NHERRQ Invalid Interrupt)	ECC=0500F004	
38	0500F005	System down (N2PHERRQ Invalid Interrupt)	ECC=0500F005	
39	0500F00B	System down (NP_ERRLOGMP Invalid Interrupt)	ECC=0500F00B	
40	0D010001	Module Error (Memory Patrol Error)	ECC=0D010001	
41		System down (Memory Patrol Error)		
42	0D810000	System down (BPU Error)	ECC=0D810000	
43	05140000	System down (ULSUB Stop)	ECC=05140000	

Table B-1 List of CPU module error codes (2/3)

No.	Information in BASE SYSTEM/S10VE error log		Indicator display	Reference for troubleshooting
	Error code	Error message		
44	03B70000	System Bus Error (Master/Target Abort)	None	Table 13-9
45	03B80002	System Bus Error (CPU Target)		
46	03D00002	Ladder Program error (Stack Overflow)		
47	03D00003	Ladder Program error (Illegal Instruction)		
48	03D00004	Ladder Program error (FP Program Error)		
49	03D00006	Ladder Program error (Illegal SH Instruction)		
50	03D01101	Ladder Program error (P-Coil CP DOWN Detect)		
51	03D0120A	Ladder Program error (Illegal User Function)		
52	03D01212	Ladder Program error (Ladder Table Empty)		
53	03D01214	Ladder Program error (Illegal Factor)		
54	05000000	Module Error (Invalid Interrupt)		
55	05000001	Module Error (Undefined Interrupt)		
56	05000002	Module Error (INTEVT Invalid Interrupt)		
57	05001001	Module Error (RQI3 INF Invalid Interrupt)		
58	05001002	Module Error (RQI3 Sub-OS registration error)		
59	05001011	Module Error (RI/O INTR Invalid Interrupt)		
60	05003001	Module Error (LV3 INTST Invalid Interrupt)		
61	05003002	Module Error (RQI6 INF Invalid Interrupt)		
62	05004001	Module Error (RINTR Invalid Interrupt)		
63	05006001	Module Error (SPU INTR Invalid Interrupt)		
64	0500A001	Module Error (NINTR Invalid Interrupt)		
65	0500B001	Module Error (PUINTR Invalid Interrupt)		
66	0500F001	Module Error (HERST Invalid Interrupt)		
67	0500F002	Module Error (HERST Invalid Interrupt(2))		
68	0500F003	Module Error (BUERRSTAT Invalid Interrupt)		
69	0500F004	Module Error (P2NHERREQ Invalid Interrupt)		
70	0500F005	Module Error (N2PHERREQ Invalid Interrupt)		
71	0500F006	Module Error (NHPMCLG Invalid Interrupt)		
72	0500F007	Module Error (ECC 2bit Master Invalid Interrupt)		
73	0500F008	Module Error (RERRMST Invalid Interrupt)		
74	0500F009	Module Error (Invalid P2NHERR Interrupt (CP Alive))		
75	0500F00B	Module Error (NP_ERRLOGMP Invalid Interrupt)		
76	0500F00C	Module Error (SPU HERR Invalid Interrupt)		
77	0500F00D	Module Error (RIO HERR Invalid Interrupt)		
78	05110000	Module Error (Macro Parameter Error)		
79	05A00001	Kernel warning		
80	05C70005	Program error (Program WDT Timeout Error)		
81	07395020	I/O error (ROM (NANDF)Error)		
82	0739D001	Module Error (RQI6 Interrupt Received)		
83	0739D002	Module Error (RQI6 Interrupt Factor (ISW6)Clear Error)		
84	07801308	I/O error (SEND_TIMEOUT)		
85	0780130A	I/O error (RESET_ERROR)		
86	07801311	I/O error (RETRY)		
87	07801312	I/O error (LATE)		
88	07801505	I/O error (INV_INTR)		
89	0D010000	Module Error (Memory Alarm)		

Table B-1 List of CPU module error codes (3/3)

No.	Information in BASE SYSTEM/S10VE error log		Indicator display	Reference for troubleshooting
	Error code	Error message		
90	0D300010	Module Error (Primary Battery Error)	None	Table 13-9
91	0D320000	Module Error (Memory Error)		
92	0D330000	Module Error (Hardware WDT timeout)		
93	0D360000	Module Error (ROM Sum Check Error)		
94	0D370000	Module Error (External Error)		
95	0D390000	Module Error (Clock Stop Error)		
96	0D800000	Module Error (TOD Error)		
97	51000001	Module Error (System Register Clear Time Out)		
98	03030000	Program error (Inst. Alignment Error)		Table 13-10
99	03040000	Program error (Illegal Instruction)		
100	03080000	Program error (Privileged Instruction)		
101	03390000	Program error (FP Program Error)		
102	03400000	Program error (Instruction Page Fault)		
103	03420000	Program error (Invalid Inst. Access)		
104	03460000	Program error (Inst. Access Protection)		
105	03470000	Program error (Data Alignment Error)		
106	03600000	Program error (Data Page Fault)		
107	03620000	Program error (Invalid Data Access)		
108	03660000	Program error (Data Access Protection)		
109	03B70001	System Bus Error (S10 Bus DTACK Timeout)		
110	03D00001	Ladder Program error (Data Access Protection)		
111	03D01208	Ladder Program error (N-Coil Nesting Over)		
112	03D0120C	Ladder Program error (Illegal Function Parameter)		
113	03D01210	Ladder Program error (Ladder Area Sum Mismatch)		
114	05110000	Macro parameter error		
115	05130000	Macro parameter error		
116	07801310	I/O error (LOSS)		
117	07801508	I/O error (BUF_OVF)		
118	0780150D	I/O error (STATION_NUM)		
119	0780150F	I/O error (SOCKET_OVF)		
120	07801510	I/O error (IFCONFIG_UP)		
121	07801511	I/O error (NETADDR_DUPL)		
122	07801512	I/O error (IPADDR_DUPL)		
123	0D340000	Module Error (Software WDT Timeout)		
124	0D350000	Module Error (RAM Sum Check Error)		
125	51000000	Module Error (Optional Module startup check error)		
126	51000002	Module Error (Optional Paramater size Error)		
127	00000201	Message frame error		
128	00000401	Buffer status		
129	00000501	Socket error		
130	00000601	Transfer memory address error		

B. List of Error Codes

Table B-2 List of OD.RING module error codes

No.	Information in BASE SYSTEM/S10VE error log		Indicator display	Reference for troubleshooting
	Error code	Error message		
1	50010100	I/O error (OD.RING Module switch setting error)	010100	Table 13-4
2	50010101	I/O error (OD.RING CPL switch setting error)	010101	
3	50010111	I/O error (OD.RING Duplicate CPL No.)	010111	
4	50010112	I/O error (OD.RING Parameter type Mismatch/SUM err)	010112	
5	50010010	Module Error (OD.RING Bus error)	010010	
6	50010011	Module Error (OD.RING Invalid address)	010011	
7	50010012	Module Error (OD.RING Invalid instruction)	010012	
8	50010013	Module Error (OD.RING Division by zero)	010013	
9	50010014	Module Error (OD.RING Privilege violation)	010014	
10	50010015	Module Error (OD.RING WDT timeout error)	010015	
11	50010016	Module Error (OD.RING Format error)	010016	
12	50010017	Module Error (OD.RING Spurious Interrupt)	010017	
13	50010018	Module Error (OD.RING Unused exception)	010018	
14	50010019	Module Error (OD.RING Parity error)	010019	
15	5001001A	Module Error (OD.RING Prepare for Grand Reset)	01001A	
16	50010102	Module Error (OD.RING ROM1 checksum error)	010102	
17	50010103	Module Error (OD.RING RAM1 compare error)	010103	
18	50010105	Module Error (OD.RING RAM2 compare error)	010105	
19	5001010B	Module Error (OD.RING ROM3 checksum error)	01010B	
20	5001010C	Module Error (OD.RING ROM erasing error (program))	01010C	
21	5001010D	Module Error (OD.RING ROM writing error (program))	01010D	
22	5001010E	Module Error (OD.RING ROM erasing error (parameter))	01010E	
23	5001010F	Module Error (OD.RING ROM writing error (parameter))	01010F	
24	50010110	Module Error (OD.RING ROM writing over 50000 times)	010110	

Table B-3 List of J.NET module error codes (1/2)

No.	Information in BASE SYSTEM/S10VE error log		Indicator display	Reference for troubleshooting
	Error code	Error message		
1	50030100	I/O error (J.NET Module switch setting error)	030100	Table 13-6
2	50030101	I/O error (J.NET Baud rate switch setting error)	030101	
3	50030112	I/O error (J.NET Parameter type Mismatch/SUM error)	030112	
4	50030010	Module Error (J.NET Bus error)	030010	
5	50030011	Module Error (J.NET Invalid address)	030011	
6	50030012	Module Error (J.NET Invalid instruction)	030012	
7	50030013	Module Error (J.NET Division by zero)	030013	
8	50030014	Module Error (J.NET Privilege violation)	030014	
9	50030015	Module Error (J.NET WDT timeout error)	030015	
10	50030016	Module Error (J.NET Format error)	030016	
11	50030017	Module Error (J.NET Spurious Interrupt)	030017	
12	50030018	Module Error (J.NET Unused exception)	030018	
13	50030019	Module Error (J.NET Parity error)	030019	
14	50030102	Module Error (J.NET ROM1 checksum error)	030102	
15	50030103	Module Error (J.NET RAM1 compare error)	030103	
16	50030105	Module Error (J.NET RAM2 compare error)	030105	
17	50030107	Module Error (J.NET DMA1 send error)	030107	
18	50030108	Module Error (J.NET DMA2 send error)	030108	
19	50030109	Module Error (J.NET DMA1 receive error)	030109	
20	5003010A	Module Error (J.NET DMA2 receive error)	03010A	
21	5003010B	Module Error (J.NET ROM3 checksum error)	03010B	
22	5003010C	Module Error (J.NET ROM erasing error (program))	03010C	
23	5003010D	Module Error (J.NET ROM writing error (program))	03010D	
24	5003010E	Module Error (J.NET ROM erasing error (parameter))	03010E	
25	5003010F	Module Error (J.NET ROM writing error (parameter))	03010F	
26	50030110	Module Error (J.NET ROM writing error (writing over))	030110	
27	50032010	I/O error (J.NET CRC error)	None	
28	50032020	I/O error (J.NET Station No. error)		
29	50032030	I/O error (J.NET Undefined service operated)		
30	50032040	I/O error (J.NET I / UI-frame length error)		
31	50032041	I/O error (J.NET I-frame format error(non Exist))		
32	50032042	I/O error (J.NET I-frame format error(Exist))		
33	50032050	I/O error (J.NET Data link sequence error)		
34	50032060	I/O error (J.NET Slave response Timeout error)		
35	50032061	I/O error (J.NET recover not successful)		
36	50032070	I/O error (J.NET Transmit/Receive error)		
37	50032080	I/O error (J.NET error occurred (.etc))		
38	50037061	I/O error (J.NET Waiting Input data)		
39	50037110	I/O error (J.NET Undefined service operated)		
40	50037120	I/O error (J.NET Transmission data length error)		
41	50037130	I/O error (J.NET Transmission packet error)		
42	50038020	I/O error (J.NET Initialize refused)		
43	50038081	I/O error (J.NET SVPT TX Bytes unmatched(Auto mode))		
44	50038082	I/O error (J.NET SVPT TX Bytes unmatched(Slot))		
45	50039001	I/O error (J.NET Station stopped)		

B. List of Error Codes

Table B-3 List of J.NET module error codes (2/2)

No.	Information in BASE SYSTEM/S10VE error log		Indicator display	Reference for troubleshooting
	Error code	Error message		
46	50039002	I/O error (J.NET Station error status detected)	None	Table 13-18
47	50039003	I/O error (J.NET St.err status detected and Stopped)		
48	5003A020	I/O error (J.NET PUT/GET(Insufficient address data))		
49	5003A021	I/O error (J.NET PUT/GET(addr field number illegal))		
50	5003A022	I/O error (J.NET PUT/GET(addr field format error))		
51	5003A040	I/O error (J.NET PUT/GET(Slot setting))		

Table B-4 List of D.NET module error codes

No.	Information in BASE SYSTEM/S10VE error log		Indicator display	Reference for troubleshooting
	Error code	Error message		
1	5004140A	I/O error (D.NET Invalid MODU No. switch setting)	04140A	Table 13-7
2	50044181	Module Error (D.NET Duplicated MAC ID(Other-Node Stop))	044181	
3	50044281	Module Error (D.NET Duplicated MAC ID(Self-Node Stop))	044281	
4	50045188	I/O error (D.NET TX data size setting error)	045188	
5	50045189	I/O error (D.NET Parameter type Mismatch/SUM error)	045189	
6	50041401	Module Error (D.NET MPU Register Compare Error)	041401	
7	50041402	Module Error (D.NET MPU Operation Check Error)	041402	
8	50041403	Module Error (D.NET CAN Register Compare Error)	041403	
9	50041405	Module Error (D.NET FROM Compare Check Error)	041405	
10	50041406	Module Error (D.NET FROM Checksum Error(microprogram))	041406	
11	50041407	Module Error (D.NET SRAM Compare Check Error)	041407	
12	50041409	Module Error (D.NET MPU Built-in Timer Diagnosis Error)	041409	
13	5004140D	Module Error (D.NET FROM Checksum Error(parameter))	04140D	
14	50042404	Module Error (D.NET Watch-Dog-Timer Timeout Error)	042404	
15	50043400	Module Error (D.NET Undefined interrupt)	043400	
16	50043404	Module Error (D.NET General Invalid Instruction)	043404	
17	50043406	Module Error (D.NET Slot Invalid Instruction)	043406	
18	50043409	Module Error (D.NET Address Error)	043409	
19	50047082	I/O error (D.NET Recover from Transmission Bus Off)	None	Table 13-24
20	50047381	I/O error (D.NET Transmission Bus Off)		
21	50048181	I/O error (D.NET CAN Transmission Timeout Error.)		

Table B-5 List of FL.NET module error codes (1/2)

No.	Information in BASE SYSTEM/S10VE error log		Indicator display	Reference for troubleshooting
	Error code	Error message		
1	50027D10	I/O error (FL.NET INVALID MAIN/SUB SWITCH SETTING)	027D10	Table 13-5
2	50027D12	I/O error (FL.NET MAIN/SUB SW SETTING DUPLICATION)	027D12	
3	5002010B	I/O error (FL.NET Parameter type Mismatch/SUM error)	02010B	
4	50020113	I/O error (FL.NET IP address not registered)	020113	
5	50020201	I/O error (FL.NET Duplicate common memory settings)	020201	
6	50020202	I/O error (FL.NET Duplicate node numbers)	020202	
7	50020203	I/O error (FL.NET module setting error)	020203	
8	50027512	I/O error (FL.NET I/O IPADDR_DUPL)	027512	
9	50020204	I/O error (FL.NET Token hold timeout)	None	
10	50020200	I/O error (FL.NET NetWK participation not completed)		
11	50020114	Module Error (FL.NET MAC address not registered)	020114	
12	50023031	Module Error (FL.NET Inst. Alignment Error)	023031	
13	50023041	Module Error (FL.NET Illegal Instruction)	023041	
14	50023081	Module Error (FL.NET Privileged Instruction)	023081	
15	500230F9	Module Error (FL.NET Illegal Exception)	0230F9	
16	50023389	Module Error (FL.NET FP Unavailable)	023389	
17	50023391	Module Error (FL.NET FP Program Error)	023391	
18	50023401	Module Error (FL.NET Instruction Page Fault)	023401	
19	50023421	Module Error (FL.NET Invalid Inst. Access)	023421	
20	50023461	Module Error (FL.NET Inst. Access Protection)	023461	
21	50023471	Module Error (FL.NET Data Alignment Error)	023471	
22	50023601	Module Error (FL.NET Data Page Fault)	023601	
23	50023621	Module Error (FL.NET Invalid Data Access)	023621	
24	50023661	Module Error (FL.NET Data Access Protection)	023661	
25	50023820	Module Error (FL.NET Memory Error)	023820	
26	500238A0	Module Error (FL.NET Memory Access Error)	0238A0	
27	500238B0	Module Error (FL.NET Internal Bus Parity)	0238B0	
28	500238C0	Module Error (FL.NET System Bus Parity)	0238C0	
29	500238F0	Module Error (FL.NET Undefined Machine Check)	0238F0	
30	50023B70	Module Error (FL.NET Bus Target Abort)	023B70	
31	50025000	Module Error (FL.NET Invalid Interrupt)	025000	
32	50025001	Module Error (FL.NET Undefined Invalid Interrupt)	025001	
33	50025002	Module Error (FL.NET INTEVT Invalid Interrupt)	025002	
34	50025011	Module Error (FL.NET RQI3 INT Invalid Interrupt)	025011	
35	50025012	Module Error (FL.NET RQI3 Link Invalid Interrupt)	025012	
36	50025013	Module Error (FL.NET RQI3 Module Invalid Interrupt)	025013	
37	50025031	Module Error (FL.NET LV3 INTST Invalid Interrupt)	025031	
38	50025032	Module Error (FL.NET RQI6 INF Invalid Interrupt)	025032	
39	50025051	Module Error (FL.NET RINTR Invalid Interrupt)	025051	
40	500250B1	Module Error (FL.NET PUINTR Invalid Interrupt)	0250B1	
41	500250C1	Module Error (FL.NET NINTR Invalid Interrupt)	0250C1	
42	500250F1	Module Error (FL.NET HERST Invalid Interrupt)	0250F1	
43	500250F2	Module Error (FL.NET HERST2 Invalid Interrupt)	0250F2	
44	500250F3	Module Error (FL.NET BUERRSTAT Invalid Interrupt)	0250F3	
45	500250F6	Module Error (FL.NET NHPMCLG Invalid Interrupt)	0250F6	
46	500250F7	Module Error (FL.NET ECC 2bit Master Invalid Interrupt)	0250F7	
47	500250F8	Module Error (FL.NET RERRMST Invalid Interrupt)	0250F8	
48	50025110	Module Error (FL.NET Macro parameter error)	025110	

Table B-5 List of FL.NET module error codes (2/2)

No.	Information in BASE SYSTEM/S10VE error log		Indicator display	Reference for troubleshooting
	Error code	Error message		
49	50025130	Module Error (FL.NET Undefined Macro)	025130	Table 13-5
50	50025700	Module Error (FL.NET System Error)	025700	
51	50025800	Module Error (FL.NET Kernel Trap)	025800	
52	50025C70	Module Error (FL.NET WDT timeout error)	025C70	
53	50027308	Module Error (FL.NET I/O SEND_TIMEOUT)	027308	
54	5002730A	Module Error (FL.NET I/O RESET_ERROR)	02730A	
55	5002730E	Module Error (FL.NET I/O MEMORY)	02730E	
56	50027370	Module Error (FL.NET I/O EC_PCI_ERROR)	027370	
57	50027400	Module Error (FL.NET I/O PCI_BUS_ERR)	027400	
58	50027505	Module Error (FL.NET I/O INV_INTR)	027505	
59	50027510	Module Error (FL.NET I/O IFCONFIG_UP)	027510	
60	50027D01	Module Error (FL.NET INVALID EXCEPTION)	027D01	
61	50027D13	Module Error (FL.NET ETHERNET LSI CHECK ERROR)	027D13	
62	50027D14	Module Error (FL.NET SDRAM CHECK ERROR)	027D14	
63	50027D15	Module Error (FL.NET OS-ROM CHECKSUM ERROR)	027D15	
64	50027D18	Module Error (FL.NET TASK-ROM CHECKSUM ERROR)	027D18	
65	5002D010	Module Error (FL.NET Memory Alarm)	02D010	
66	5002D330	Module Error (FL.NET Hardware WDT timeout)	02D330	
67	5002D340	Module Error (FL.NET Software WDT Timeout)	02D340	
68	5002D810	Module Error (FL.NET BPU Error)	02D810	
69	50027310	I/O error (FL.NET I/O CARRIER LOSS)	None	Table 13-25
70	50027311	I/O error (FL.NET I/O RETRY)		
71	50027312	I/O error (FL.NET I/O LATE)		
72	50027351	I/O error (FL.NET I/O TX_ABORT)		
73	50027353	I/O error (FL.NET I/O TX_DEFER)		
74	50027375	I/O error (FL.NET I/O RX_STAT_OVER)		
75	50027376	I/O error (FL.NET I/O TX_DATA_UNDER)		
76	50027377	I/O error (FL.NET I/O RX_DATA_OVER)		
77	50027508	I/O error (FL.NET I/O BUF_OVF)		
78	5002750F	I/O error (FL.NET I/O SOCKET_OVF)		

Table B-6 List of ET.NET module error codes (1/2)

No.	Information in BASE SYSTEM/S10VE error log		Indicator display	Reference for troubleshooting
	Error code	Error message		
1	500E7D13	Module error (ET.NET ETHERNET LSI CHECK ERROR)	0E7D13	Table 13-28
2	500E7D14	Module error (ET.NET SDRAM CHECK ERROR)	0E7D14	
3	500E7D18	Module error (ET.NET ROM CHECKSUM ERROR)	0E7D18	
4	500E3031	Module error (ET.NET Inst. Alignment Error)	0E3031	
5	500E3041	Module error (ET.NET Illegal Instruction)	0E3041	
6	500E3081	Module error (ET.NET Privileged Instruction)	0E3081	
7	500E30F9	Module error (ET.NET Illegal Exception)	0E30F9	
8	500E3389	Module error (ET.NET FP Unavailable)	0E3389	
9	500E3391	Module error (ET.NET FP Program Error)	0E3391	
10	500E3401	Module error (ET.NET Instruction Page Fault)	0E3401	
11	500E3421	Module error (ET.NET Invalid Inst. Access)	0E3421	
12	500E3461	Module error (ET.NET Inst. Access Protection)	0E3461	
13	500E3471	Module error (ET.NET Data Alignment Error)	0E3471	
14	500E3601	Module error (ET.NET Data Page Fault)	0E3601	
15	500E3621	Module error (ET.NET Invalid Data Access)	0E3621	
16	500E3661	Module error (ET.NET Data Access Protection)	0E3661	
17	500E3820	Module error (ET.NET Memory Error)	0E3820	
18	500E3B70	Module error (ET.NET Bus Target Abort)	0E3B70	
19	500E3B81	Module error (ET.NET System Bus Error CPU Master)	0E3B81	
20	500E3B82	Module error (ET.NET System Bus Error CPU Target)	0E3B82	
21	500E3B90	Module error (ET.NET PCI_BUS_ERR)	0E3B90	
22	500E5001	Module error (ET.NET Undefined Invalid Interrupt)	0E5001	
23	500E5002	Module error (ET.NET INTEVT Invalid Interrupt)	0E5002	
24	500E50F1	Module error (ET.NET HERST Invalid Interrupt)	0E50F1	
25	500E50F2	Module error (ET.NET HERST2 Invalid Interrupt)	0E50F2	
26	500E50F3	Module error (ET.NET BUERRSTAT Invalid Interrupt)	0E50F3	
27	500E50F6	Module error (ET.NET NHPMCLG Invalid Interrupt)	0E50F6	
28	500E50F7	Module error (ET.NET ECC 2bit Master Invalid Interrupt)	0E50F7	
29	500E50F8	Module error (ET.NET RERRMST Invalid Interrupt)	0E50F8	
30	500E5110	Module error (ET.NET Macro parameter error)	0E5110	
31	500E5130	Module error (ET.NET Undefined Macro)	0E5130	
32	500E5700	Module error (ET.NET System Error)	0E5700	
33	500E5800	Module error (ET.NET Kernel Trap)	0E5800	
34	500E5C70	Module error (ET.NET WDT timeout error)	0E5C70	
35	500E7308	Module error (ET.NET SEND_TIMEOUT)	0E7308	
36	500E730A	Module error (ET.NET RESET_ERROR)	0E730A	
37	500E7505	Module error (ET.NET INV_INTR)	0E7505	
38	500E7510	I/O error (ET.NET IFCONFIG_UP)	0E7510	
39	500E7511	I/O error (ET.NET NETADDR_DUPL)	0E7511	
40	500E7512	I/O error (ET.NET IPADDR_DUPL)	0E7512	
41	500E7D1C	I/O error (ET.NET Invalid network setting)	0E7D1C	
42	500E7D01	Module error (ET.NET INVALID EXCEPTION)	0E7D01	
43	500E7D11	Module error (ET.NET Invalid MAC ADDRESS)	0E7D11	
44	500E7D12	I/O error (ET.NET Invalid MAIN/SUB switch setting Duplication)	0E7D12	
45	500E7D1A	I/O error (ET.NET Invalid MAIN/SUB switch setting)	0E7D1A	
46	500E7D1B	I/O error (ET.NET Invalid ST. No. switch setting)	0E7D1B	
47	500ED010	Module error (ET.NET Memory Alarm)	0ED010	
48	500ED810	Module error (ET.NET BPU Error)	0ED810	

Table B-6 List of ET.NET module error codes (2/2)

No.	Information in BASE SYSTEM/S10VE error log		Indicator display	Reference for troubleshooting
	Error code	Error message		
49	03030000	Inst. Alignment Error	0E3031	Table 13-29
50	03040000	Illegal Instruction	0E3041	
51	03080000	Privileged Instruction	0E3081	
52	030F0000	Illegal Exception	0E30F9	
53	03380000	FP Unavailable	0E3389	
54	03390000	FP Program Error	0E3391	
55	03400000	Instruction Page Fault	0E3401	
56	03420000	Invalid Inst. Access	0E3421	
57	03460000	Inst. Access Protection	0E3461	
58	03470000	Data Alignment Error	0E3471	
59	03600000	Data Page Fault	0E3601	
60	03620000	Invalid Data Access	0E3621	
61	03660000	Data Access Protection	0E3661	
62	03820000	Memory Error	0E3820	
63	03B70000	Master/ Target Abort	0E3B70	
64	03B80001	System Bus Error CPU Master	0E3B81	
65	03B80002	System Bus Error CPU Target	0E3B82	
66	03B90000	PCI_BUS_ERR	0E3B90	
67	05000001	Undefined Invalid Interrupt	0E5001	
68	0500**** #1	Invalid Interrupt		
69	05000002	INTEVT Invalid Interrupt	0E5002	
70	0500F001	HERST Invalid Interrupt	0E50F1	
71	0500F002	HERST Invalid Interrupt(2)	0E50F2	
72	0500F003	BUERRSTAT Invalid Interrupt	0E50F3	
73	0500F006	MHPMCLG Invalid Interrupt	0E50F6	
74	0500F007	ECC 2bit Master Invalid Interrupt	0E50F7	
75	0500F008	RERRMST Invalid Interrupt	0E50F8	
76	05110000	Macro parameter error	0E5110	
77	05130000	Invalid Macro	0E5130	
78	05140000	ULSUB STOP	0E5700	
79	0570000* #2	System Error		
80	05800000	Kernel Trap	0E5800	
81	05C70000	WDT timeout error	0E5C70	
82	07801308	SEND_TIMEOUT	0E7308	
83	0780130A	RESET_ERROR	0E730A	
84	07801505	INV_INTR	0E7505	
85	07801510	IFCONFIG_UP	0E7510	
86	07801511	NETADDR_DUPL	0E7511	
87	07801512	IPADDR_DUPL	0E7512	
88	07807D1C	Invalid network setting	0E7D1C	
89	0D010000	Memory Alarm	0ED010	
90	0D810000	BPU Error	0ED810	

#1: Error code No. 68 is output for an invalid interrupt if none of No. 67 or No. 69 to No. 75 apply.

#2: Each asterisk (*) is replaced with a 0 or 1.

This page is intentionally left blank.

Appendix C. Replacing Software Products in BASE SET/S10VE

C.1 Preface

This appendix explains how to replace software products in BASE SET/S10VE (P.P. type S-7898-50) when an upgraded or revised version is available.

For a list of software products, see *Appendix 1. List of Software Programs for BASE SET/S10VE* provided with the software.

C.2 Cautionary notes

C.2.1 Cautionary notes on software product installation

The various tools provided in the S10VE that are associated with programming and operation of software (ladder diagram, HI-FLOW, and RPDP) are compatible with the Microsoft® Windows® 7 (64-bit) and Microsoft® Windows® 10 (64-bit) operating systems. Note that the following runtime libraries must be installed for the S10VE tools to work. If these runtime libraries are not installed, install them from the Microsoft Download Center before you start using the tools.

- Microsoft .NET Framework 4
- Microsoft Visual C++ 2010 Redistributable Package (x64)

- Do not attempt to start BASE SYSTEM/S10VE in an environment without Microsoft .NET Framework 4 installed. If you do so, the error message `.NET Framework Initialization Error` appears and BASE SYSTEM/S10VE cannot start.
- Do not attempt to start BASE SET/S10VE in an environment without the Microsoft Visual C++ 2010 Redistributable Package (x64) installed. If you do so, the error message `The program can't start because MSVCR110.dll is missing from your computer. Re-installing the application may fix this problem.` appears during startup, and BASE SET/S10VE terminates abnormally.

When installing a software product, refer to the documentation provided with the software product and make sure that the version and revision of BASE SYSTEM/S10VE meet the prerequisites of the product.

Notice

- Use an account with administrator privileges to install and uninstall the S10VE tools. If you use a standard account, the tools might not install or uninstall correctly.
- Exit all Windows® programs before installing each tool. This includes memory-resident programs such as anti-virus software. An error might occur if you attempt to install a tool with other programs still running. In this case, uninstall the tool you were installing and exit all Windows® programs. Then, install the tool again. For details on how to uninstall a tool, see *C.5 Uninstalling software products*.
- Do not install an S10VE tool to any of the following folders, which are protected by User Account Control:
 - Program file folder (for example, C:\Program Files)
 - System root folder (for example, C:\Windows)
 - System drive root folder (for example, C:\)
 - Program data folder (for example, C:\ProgramData)

C.2.2 Cautionary notes on CPMS/S10VE

Replacing CPMS/S10VE on the PADT does not automatically update the CPMS/S10VE in projects and on actual machines. To update CPMS/S10VE in a project or on a machine, open the project in BASE SYSTEM/S10VE and click **CPMS Update**. You can then download the updated CPMS.

C.3 Overview of software product replacement procedure

The procedure for replacing a software product has two key parts: a procedure common to all software products, and another specific to CPMS/S10VE.

(1) Common replacement procedure

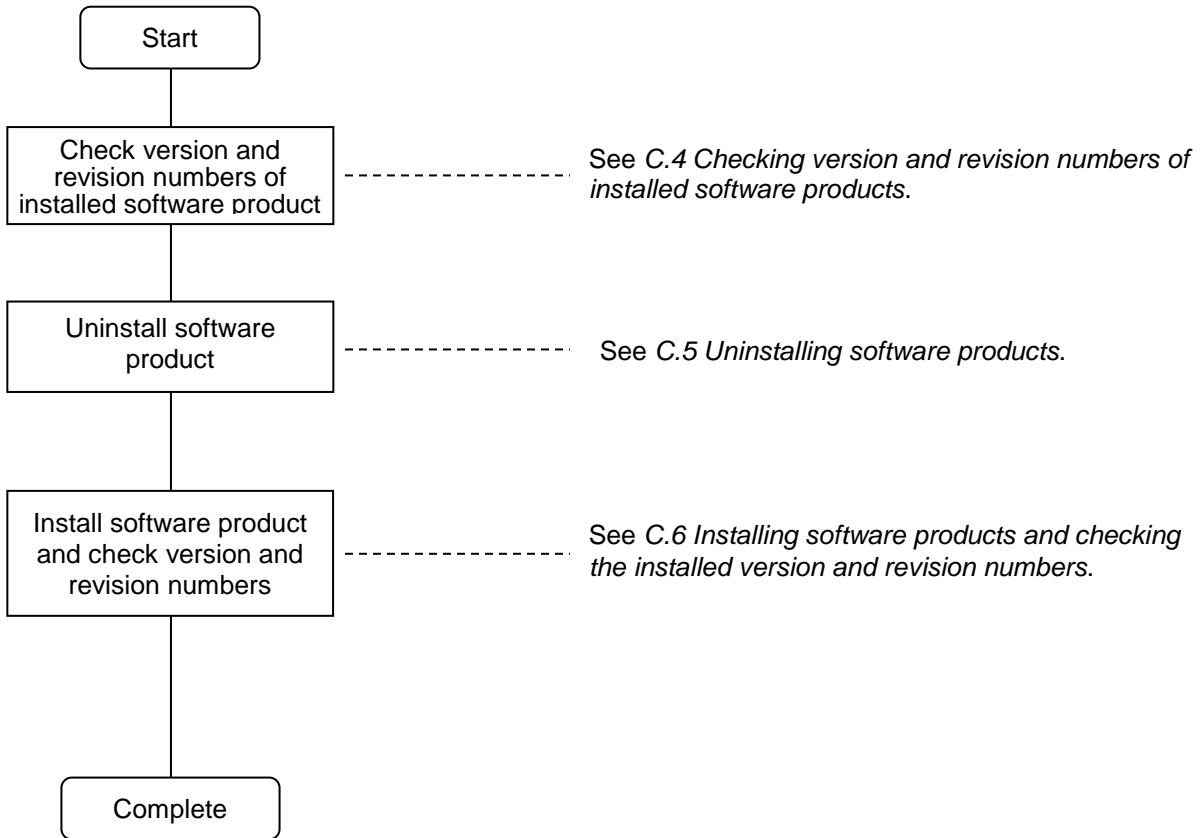

C. Replacing Software Products in BASE SET/S10VE

(2) CPMS/S10VE replacement procedure

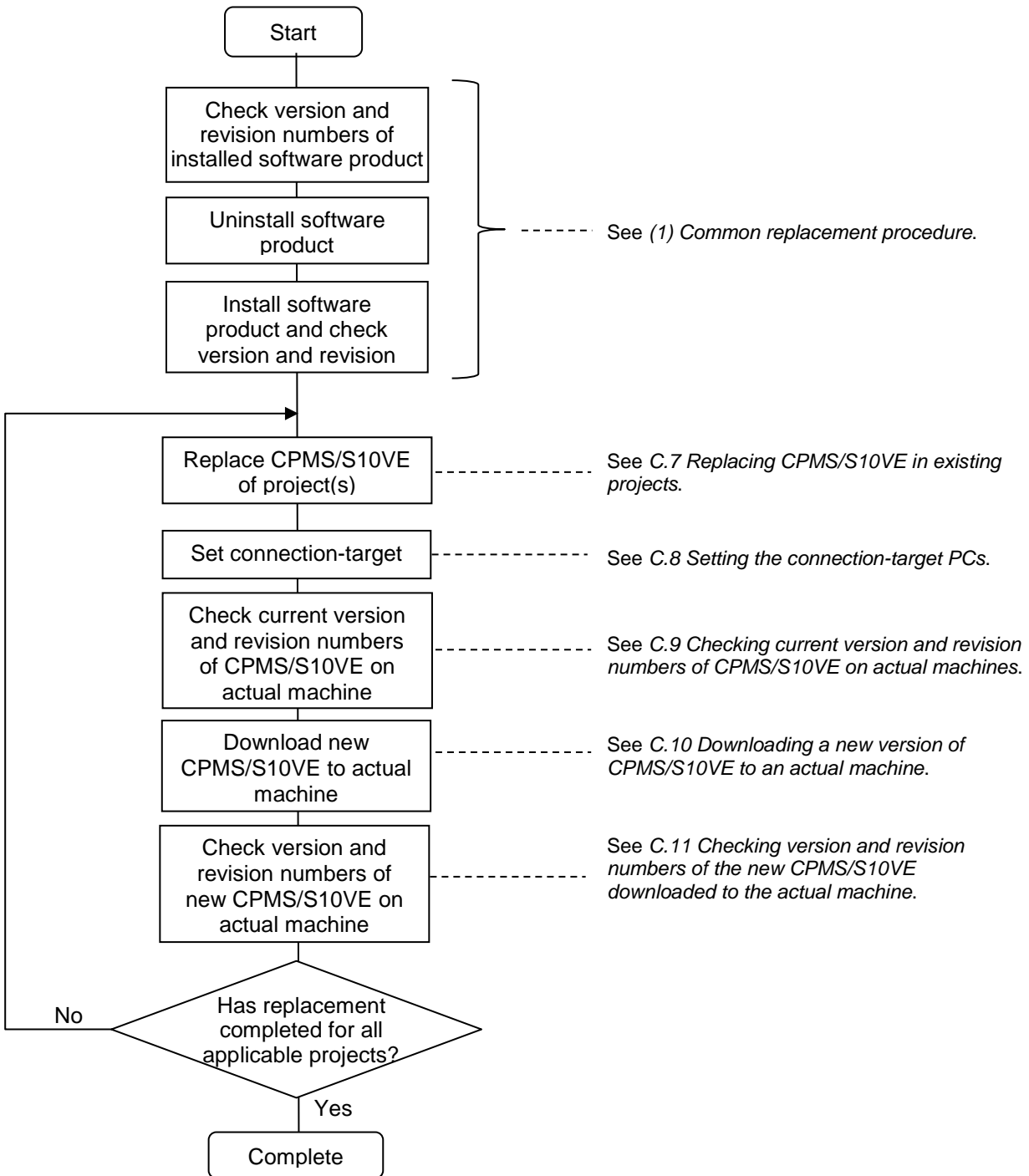

C.4 Checking version and revision numbers of installed software products

Confirm that the version and revision numbers of the software products installed on the PADT are those of a version and revision that can be replaced.

- (1) Place the BASE SET/S10VE CD in your CD-ROM drive, and double-click the file setup.exe in the root folder.
- (2) If a User Account Control dialog box appears, click Yes.
- (3) In the SETUP window that appears, confirm that the version and revision numbers of the software product installed on the PADT are those of a version and revision that can be replaced.

Note: If the version and revision numbers are those of a software product that cannot be replaced, do not go ahead with the replacement process.

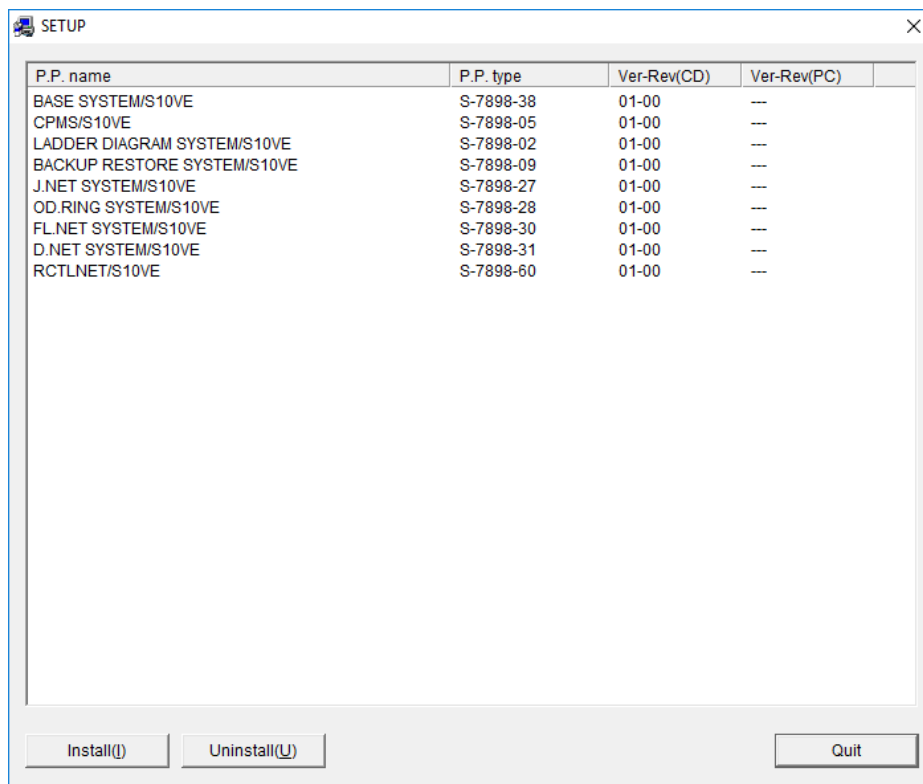

Version and revision numbers of software products installed on the PADT

Ver-Rev display example 1)

01-03
 └───┬─── REV
 └───┴─── VER } Check the version and revision numbers

Ver-Rev display example 2)

01-03-/B
 └───┬─── REV
 └───┴─── VER } Check the version and revision numbers

This completes the process of checking the version and revision numbers of the installed CPMS/S10VE.

C.5 Uninstalling software products

Uninstall the existing software product from the PADT. You can uninstall tools from the Control Panel or from the basic installation set. The following procedure uses the example of uninstalling BASE SYSTEM/S10VE from the Control Panel. Log on as an account with administrator privileges when uninstalling tools.

- (1) From the **Start** menu, open the Control Panel. Click **Uninstall a program**, and then double-click **BASE SYSTEM/S10VE**.
- (2) The message Do you want to completely remove the selected application and all of its features? appears. Click **Yes** to uninstall BASE SYSTEM/S10VE. To cancel uninstallation, click **No**.

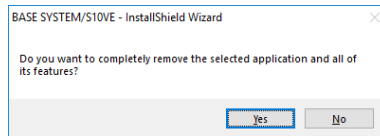

Figure C-1 "Do you want to completely remove the selected application and all of its features?" message

- (3) When uninstallation is complete, the message Uninstall Complete appears. Click **Finish**.

- If a Do you delete the shared File? window appears during uninstallation, click **No**. This leaves the shared file in place.
- If you uninstall a tool while that tool is running, a dialog box appears as shown in Figure C-3 asking whether you want to restart your computer. Restart the computer as directed. This process will remove any files that were in use.

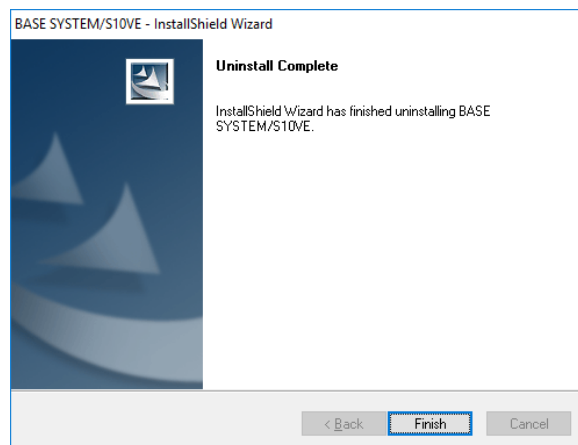

Figure C-2 Uninstall Complete message (for uninstallation with tool not running)

If you uninstall a tool without shutting it down first, the Uninstall Complete message shown in Figure C-3 appears instead of that shown in Figure C-2. Select whether you want to restart the computer now or later, and then click **Finish**.

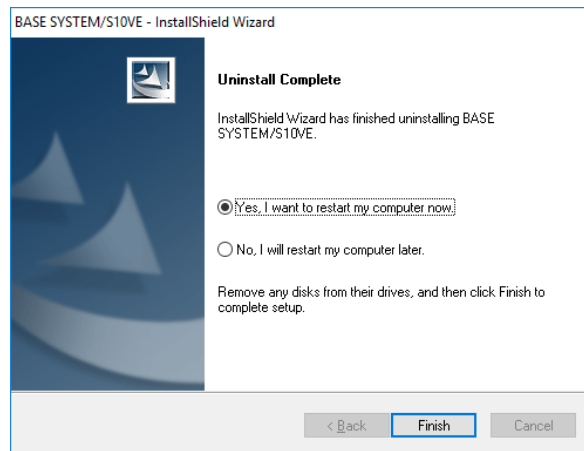

Figure C-3 Uninstall Complete message (for uninstallation of running tool)

If you restart a computer on which RPDP is installed, an RPDP internal command displays the error message shown in Figure C-4. Click **OK** to dismiss the error message. This message will not appear when you restart the computer after installing BASE SYSTEM.

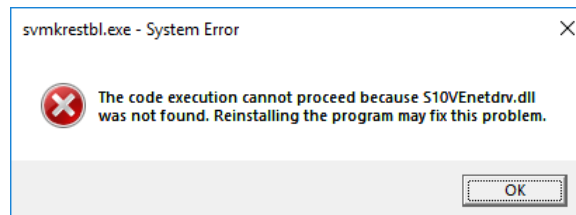

Figure C-4 Error message displayed by RPDP internal command

Uninstallation of RPDP is not supported. Only uninstall RPDP if you intend to re-install it.

C.6 Installing software products and checking the installed version and revision numbers

Install the new version/revision of the software product. You can install tools from CD media or from the basic installation set. The following explains how to install tools from the HI-FLOW SYSTEM/S10VE installation CD. Log on as an account with administrator privileges when installing the tools.

- (1) To install the HI-FLOW SYSTEM/S10VE tool, double-click `setup.exe` in the folder `S789803` on the HI-FLOW SYSTEM/S10VE installation CD. The `setup.exe` file of each tool is located in a different folder.
- (2) When you double-click `setup.exe`, the following message might appear. Click **Yes** to acknowledge the message and begin the setup process.

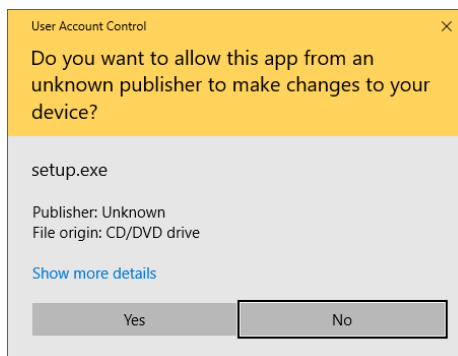

Figure C-5 User Account Control message

- (3) The InstallShield Wizard window appears. Install the tool as prompted by the messages in the installer.

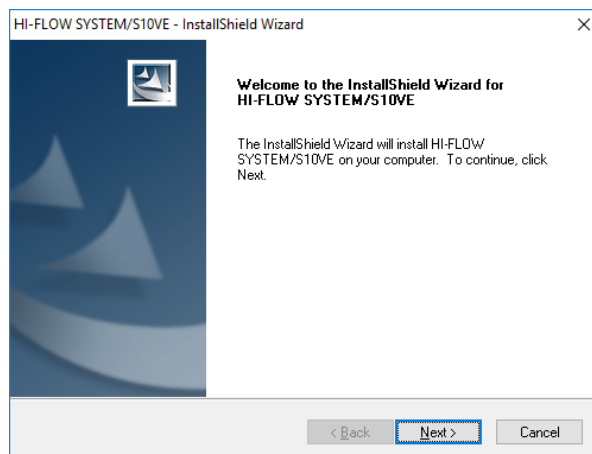

Figure C-6 InstallShield Wizard window

- (4) When the installation process has completed, the InstallShield Wizard Completed window appears. Click **Finish**.

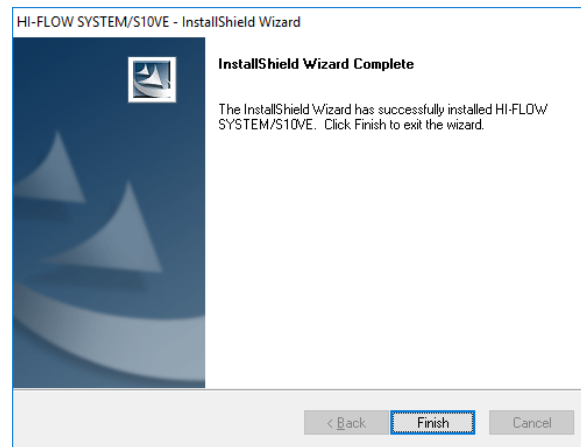

Figure C-7 InstallShield Wizard Completed window

Notice

- BASE SYSTEM/S10VE cannot be installed on a per-user basis. To install BASE SYSTEM/S10VE successfully, you must first log on to the system with an administrator account.

BASE SYSTEM/S10VE might not be installed properly in any of the following cases: 1) Administrator permissions are acquired by using User Account Control# from a standard user account, 2) The administrator account was created from a standard user account by using User Account Control.

In this case, log on with the administrator account that was first created on your PADT, and then reinstall BASE SYSTEM/S10VE.

If you log on with a user account other than that used for installing BASE SYSTEM/S10VE, the installed program might not appear in the program menu. In this case, log off and log on again with the administrator account that was first created on your PADT, uninstall the installed program, and then install the program again.

When you want to create a new account, log on with an administrator account without using User Account Control.

#: User Account Control is a Microsoft Windows feature that temporarily grants administrative rights to standard user accounts.

Check the version and revision numbers of the installed product. Make sure that the numbers in the **Ver-Rev(PC)** column in the SETUP window have been updated to the same version and revision numbers as in the **Ver-Rev(CD)** column.

C.7 Replacing CPMS/S10VE in existing projects

You can replace the CPMS of a project with a version and revision of CPMS/S10VE you have installed.

This process uses BASE SYSTEM/S10VE.

To replace the CPMS of a project, you need to be logged in to the PADT as an account with administrator privileges. If your account does not have administrator privileges, log out and then log in again with an administrator account.

- (1) Start BASE SYSTEM/S10VE.
- (2) From the **Project** menu, select **Open**. The Project List window appears.
- (3) Select the PCs number of the project whose CPMS/S10VE you want to replace, and then click **Open**.
The following figure shows an example in which the PCs number of the project is 0001.

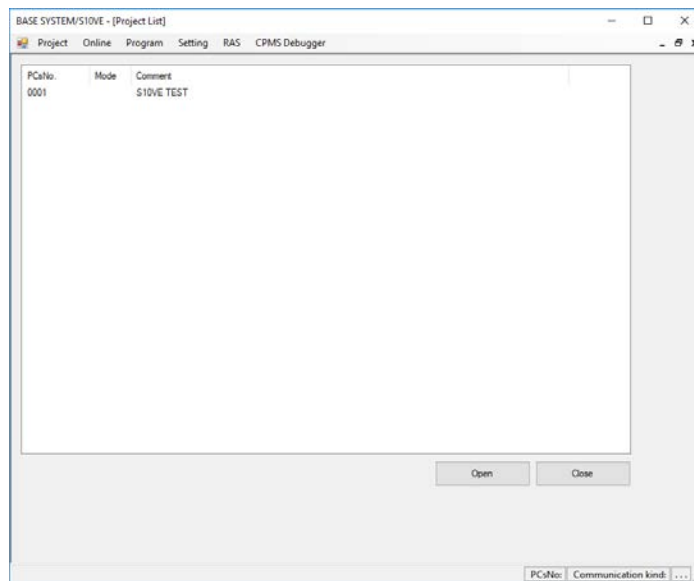

(4) In the Properties window that appears, click **CPMS Update**.

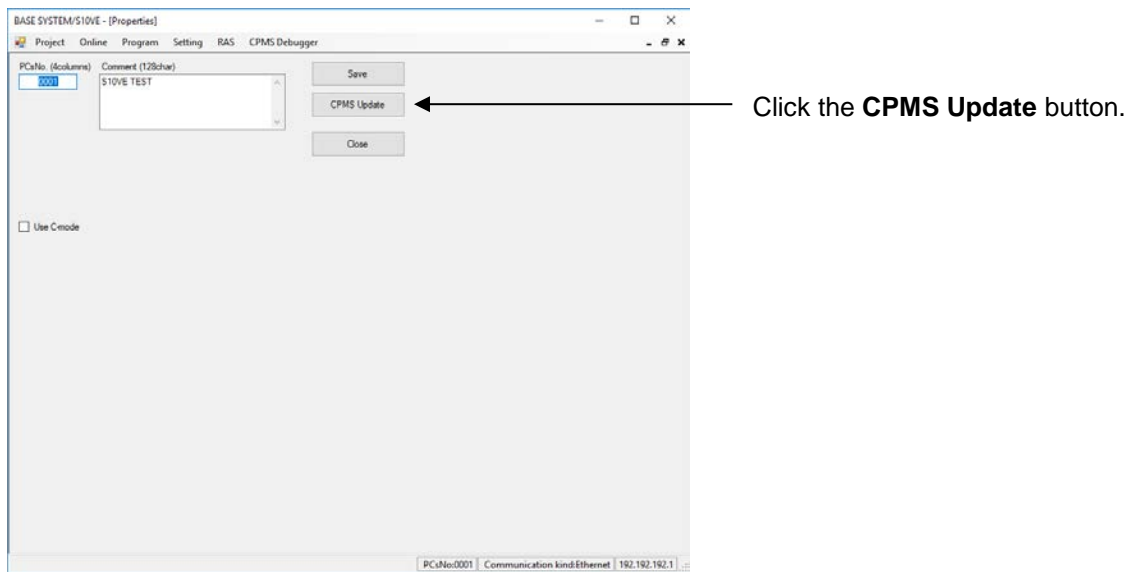

(5) A message appears asking you to confirm that you want to continue. Click **Yes**.

(6) A message appears indicating that processing has completed. Click **OK**.

This completes the process of replacing CPMS/S10VE in a project.

C.8 Setting the connection-target PCs

Set the connection-target PCs, and confirm that you are able to connect to the actual machine. This process uses BASE SYSTEM/S10VE.

- (1) From the **Online** menu, select **Change PCs**.
- (2) The Change PCs window appears.

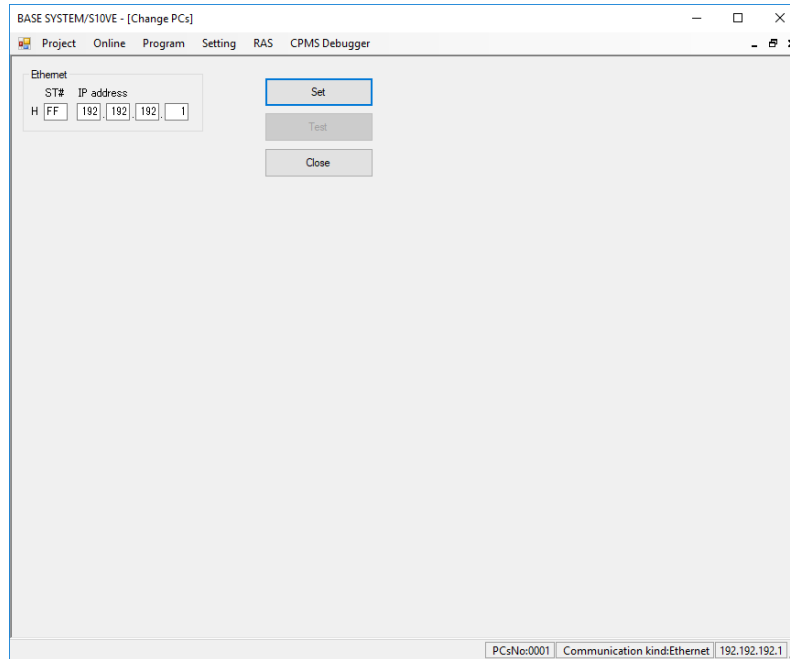

Figure C-8 Change PCs window

- (3) Set the communication type by entering a station number and IP address.
- (4) Click **Set** to assign the communication type you entered to the project.
- (5) To check whether communication is possible with the communication type you set, place the CPU module in RUN mode and then click **Test**. If BASE SYSTEM was able to communicate with the CPU module, it displays a message acknowledging a successful PCs connection (Figure C-9).

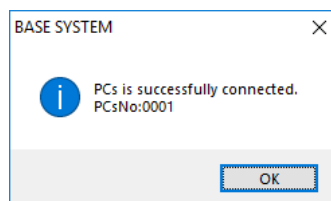

Figure C-9 Message when PCs connection is successful

The **Test** button is unavailable immediately after you change the communication type. To make the **Test** button available, you must click **Set**.

- (6) Click **Close** to close the Change PCs window.

C.9 Checking current version and revision numbers of CPMS/S10VE on actual machines

The following explains how to check the version and revision numbers of the current version of CPMS/S10VE on an actual machine.

This process uses BASE SYSTEM/S10VE.

- (1) From the **RAS** menu, select **Module List**.
- (2) Make sure that the version and revision numbers in the **Ver-Rev** column for CPMS/S10VE in the **P.P. List** area of the Module List window are those of the CPMS/S10VE you want to replace.

Note: If the version and revision numbers are not those of the CPMS/S10VE you want to replace, do not go ahead with the replacement process.

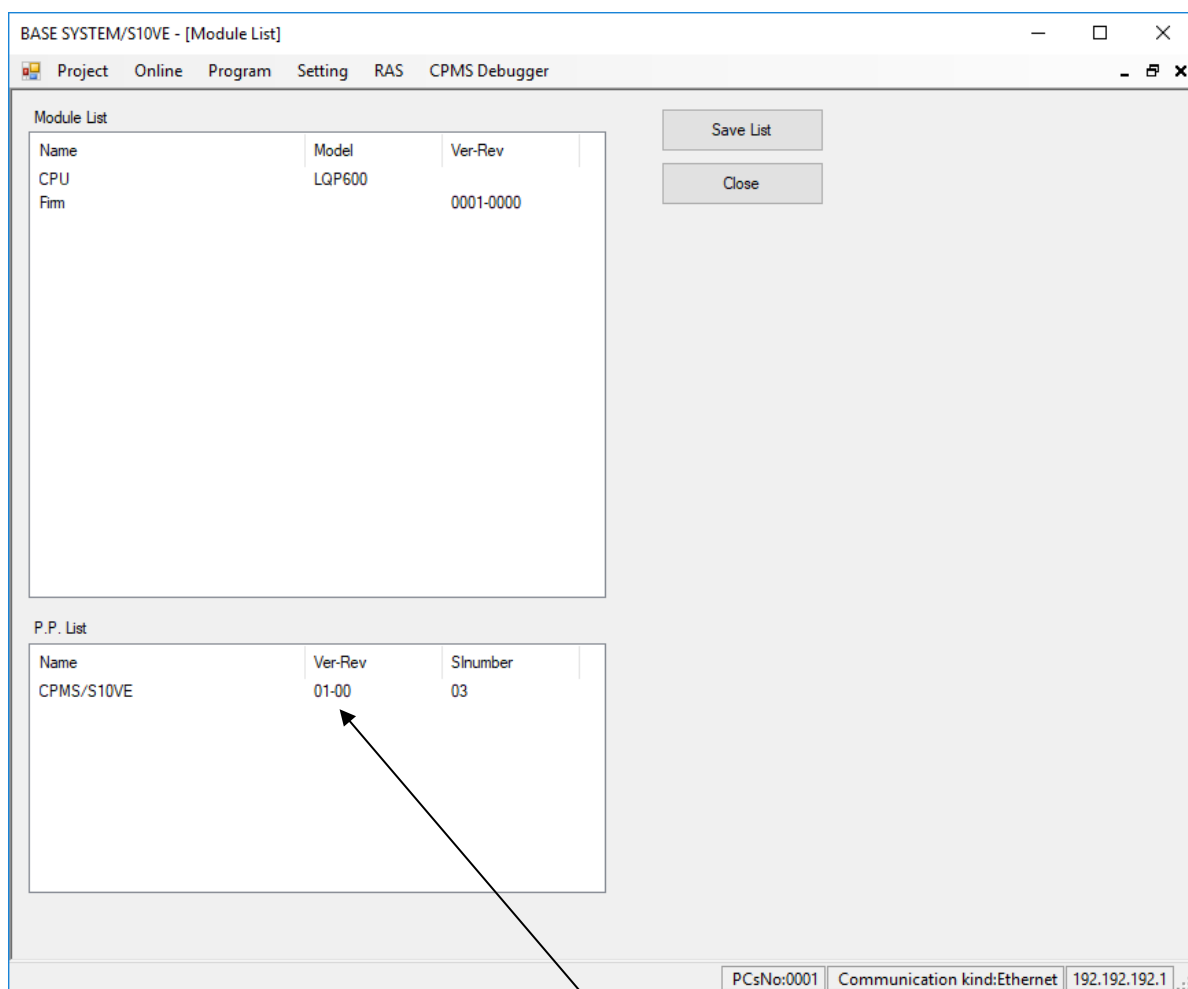

Ver-Rev of CPMS/S10VE currently on actual machine

- (3) Click **Close** to close the Module List window.

This completes the process of checking the version and revision numbers of CPMS/S10VE downloaded on an actual machine.

C.10 Downloading a new version of CPMS/S10VE to an actual machine

This appendix explains how to download the CPMS/S10VE version you installed in *C.7 Replacing CPMS/S10VE in existing projects* to the actual machine (S10VE). This process uses BASE SYSTEM/S10VE.

- (1) Set the LADDER RUN/STOP switch on the CPU module to STOP.
- (2) From the **Project** menu, select **Download CPMS**.
- (3) In the Download CPMS window that appears, click **Download**.
- (4) A message appears asking you if it is OK to reset the PCs. Click **OK** to continue.
- (5) A message appears indicating that processing has completed. Click **Close**.
- (6) Click **Close** to close the Download CPMS window.

This completes the process of downloading the new version of CPMS/S10VE.

C.11 Checking version and revision numbers of the new CPMS/S10VE downloaded to the actual machine

The following explains how to check the version and revision numbers of CPMS/S10VE on the actual machine. This process uses BASE SYSTEM/S10VE, and allows you to confirm that the new version of CPMS/S10VE has been downloaded to the actual machine.

- (1) From the **RAS** menu, select **Module List**.
- (2) In the Module List window that appears, make sure that the version and revision numbers in the **Ver-Rev** column for CPMS/S10VE in the **P.P. List** area match those of the new CPMS/S10VE you installed in *C.7 Replacing CPMS/S10VE in existing projects*.

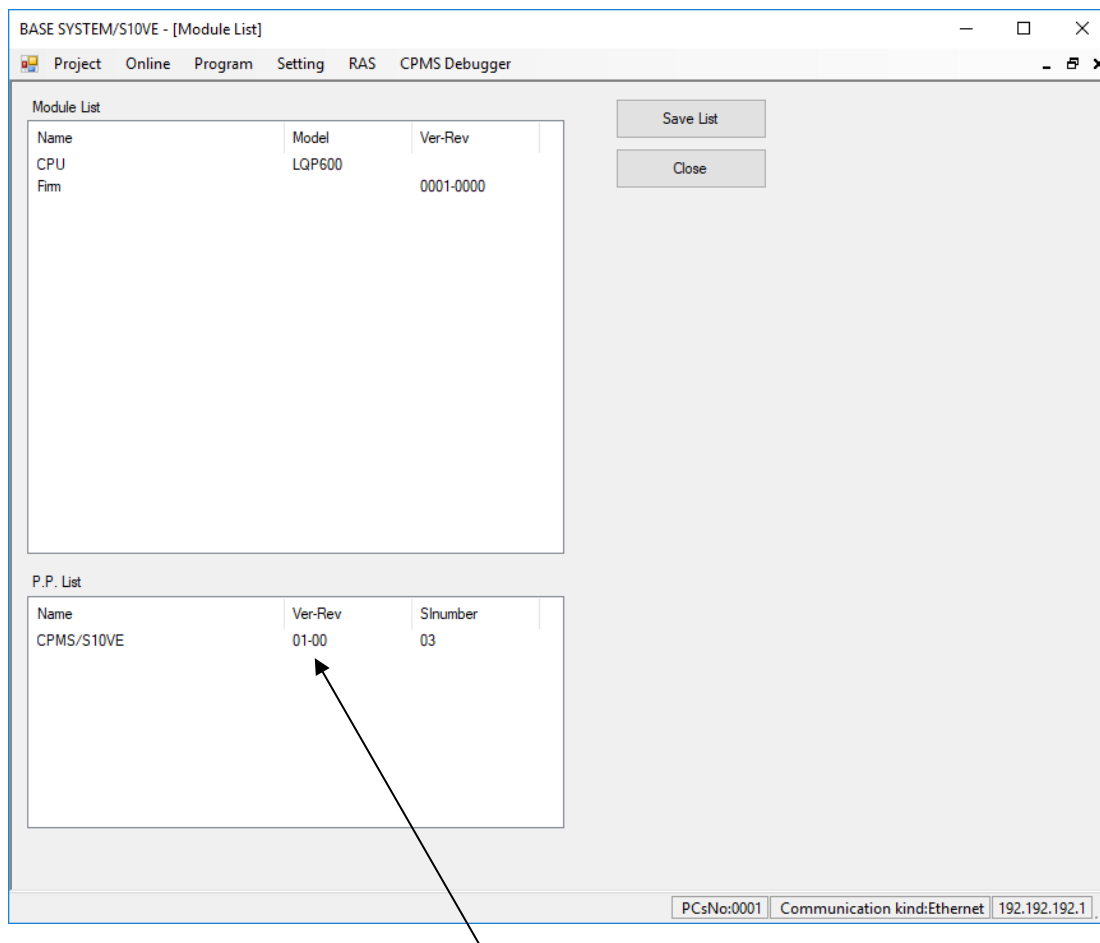

Ver-Rev of new CPMS/S10VE downloaded to actual machine

- (3) Click **Close** to close the Module List window.
- (4) Click **Close** to close the Properties window.

When you have confirmed that the version and revision of CPMS/S10VE on the actual machine match those of the CPMS/S10VE you downloaded, the process of replacing CPMS/S10VE in an existing project is complete. For each project whose CPMS/S10VE you want to replace, repeat the procedure starting from step (3) in *C.7 Replacing CPMS/S10VE in existing projects* and concluding with *C.11 Checking the version and revision of the new CPMS/S10VE downloaded to the actual machine*.

This completes the process of replacing CPMS/S10VE with a new version.

This page is intentionally left blank.