

# HITACHI

USER'S MANUAL

OPTION

**D.NET**

(LQE570/575)

---

S10mini

**SIOV**

SVE-1-106 (H)

USER'S MANUAL

OPTION

**D.NET**

(LQE570/575)

---

S10mini

**SIOV**

First Edition, March 2003, SVE-1-106(B) (out of print)  
Second Edition, March 2005, SVE-1-106(C) (out of print)  
Third Edition, February 2007, SVE-1-106(E) (out of print)  
Fourth Edition, October 2008, SVE-1-106(F) (out of print)  
Fifth Edition, November 2008, SVE-1-106(G) (out of print)  
Sixth Edition, November 2012, SVE-1-106(H)

All Rights Reserved, Copyright © 2003, 2012, Hitachi, Ltd.

The contents of this publication may be revised without prior notice.

No part of this publication may be reproduced in any form or by any means without permission in writing from the publisher.

Printed in Japan.

BI<IC> (FL-MW2007, AI10)

## SAFETY PRECAUTIONS

- Before installation, operation, maintenance, and/or inspection of this product, be sure to read through carefully this manual and other related manuals. Do not use this product until you are familiar with all the information concerning this product, safety information, and precautions provided in those manuals.
- Keep this manual in a readily accessible place so that users of this product may easily reach it.
- This manual contains information on potential hazards that is intended as a guide for safe use of this product. The potential hazards listed in the manual are divided into four hazard levels of danger, warning, caution, and notice, according to the level of their severity. The following are definitions of the safety labels containing the corresponding signal words DANGER, WARNING, CAUTION, and NOTICE.



: This safety label identifies precautions that, if not heeded, will result in death or serious injury.





: Identifies precautions that, if not heeded, could result in death or serious injury.



: Identifies precautions that, if not heeded, could result in minor or moderate injury.



: This safety label without a safety alert symbol identifies precautions that, if not heeded, could result in property damage or loss not related to personal injury.

Failure to observe any of the  **CAUTION** and  **NOTICE** statements used in this manual could also lead to a serious consequence, depending on the situation in which this product is used. Therefore, be sure to observe all of those statements without fail.

The following are definitions of the phrases “serious injury,” “minor or moderate injury,” and “property damage or loss not related to personal injury” used in the above definitions of the safety labels.

**Serious injury:** Is an injury that requires hospitalization for medical treatment, has aftereffects, and/or requires long-term follow-up care. Examples of serious injuries are as follows: vision loss, burn (caused by dry heat or extreme cold), electric-shock injury, broken bone, poisoning, etc.

**Minor or moderate injury:** Is an injury that does not require either hospitalization for medical treatment or long-term follow-up care. Examples of minor or moderate injuries are as follows: burn, electric-shock injury, etc.

**Property damage or loss not related to personal injury:** Is a damage to or loss of personal property. Examples of property damages or losses not related to personal injury are as follows: damage to this product or other equipment or their breakdown, loss of useful data, etc.

The safety precautions stated in this manual are based on the general rules of safety applicable to this product. These safety precautions are a necessary complement to the various safety measures included in this product. Although they have been planned carefully, the safety precautions posted on this product and in the manual do not cover every possible hazard. Common sense and caution must be used when operating this product. For safe operation and maintenance of this product, establish your own safety rules and regulations according to your unique needs. A variety of industry standards are available to establish such safety rules and regulations.

## 1. General Safety Guidelines

Before installing, operating inspecting or conducting maintenance on this unit, read the following instructions carefully:

- Follow all the operating procedures provided in this manual.
- Pay special attention to and follow all the hazard warnings on the machine and in the manual. Failure to do so can cause injury to yourself or damage to the machine.
- Do not perform any operation or action in any way other than as provided in this manual. When in doubt, call the designated field engineer. Keep in mind that the hazard warnings in this manual or on the machine cannot cover every possible case, as it is impossible to predict and evaluate all circumstances beforehand.  
Be alert and use your common sense.
- Do not install, wire, handle, modify, or use maintenance parts in any manner not described in this manual. Such a practice may result in breakdown of this equipment or peripherals, injury or even death. Hitachi will not be responsible for any accident or failure resulting from such mishandling.

Read the following safety guidelines carefully and follow them when you conduct maintenance of the machine.

### Before starting maintenance

- Maintenance of the machine must be done only by trained and qualified field engineers.
- Read and follow the safety guidelines and procedures in this manual and the related manuals.
- In this manual and on the machine, hazard warnings are provided to aid you in preventing or reducing the risk of death, personal injury, or product damage. Understand and follow these hazard warnings fully.
- Keep in mind that the hazard warnings in this manual or on the machine cannot cover every possible case, as it is impossible to predict and evaluate all circumstances beforehand.  
Be alert and use your common sense.

### During work

- For each procedure, follow the given sequence of steps.
- Use the special tools and instruments, specified for the work in the manual or commercially available tools and instruments which fit the purpose.
- Use measurement instruments and powered tools which are properly calibrated or periodically inspected.
- Keep the maintenance area neat and tidy.
- Always put away parts, materials or tools when not in use.
- Wear an eye protector where anything may fly about.
- When using sharp objects or cutting tools, make sure that no part of your body lies in the path of the blade bit, or point.
- Before finishing your work, make sure that all parts removed during maintenance have been installed back in their original positions in the machine.  
Make sure that no tool or foreign material is left in the machine.

## Prevention of electric shocks

- Before starting work, make sure that, unless otherwise specifically instructed, there is no potential electric hazard in the maintenance area such as insufficient grounding or a wet floor.
- Before starting work, note where the emergency power-off switches are located and make sure you know how to operate them.
- Unless otherwise specifically instructed, cut off all power sources to the machine before starting maintenance. Just switching off the machine power supplies is usually not enough.

When power is fed from a wall or floor outlet, unplug the power supply cord, or turn off the switch on the power distribution panel or board. Attach a notice on the panel or board prohibiting the use of the switch.

If the energy isolating device such as the switch on the power distribution panel or board accepts a lockout device, turn off the power, lock out the energy isolating device, and bring the key with you. When you take over the work and the key for the lockout device if applicable, do not assume that the power is off. Make sure yourself that the above-mentioned conditions such as switches are satisfied. If necessary, use a measurement tool to ensure that the power is off.

- Do not touch any uninsulated conductor or surface, where so instructed, which remains charged for a limited time after the external power supply to the machine is disconnected.
- When working on a machine which has a grounding terminal, make sure that the terminal is properly connected to the facility's ground.
- When working close to a hazardously energized part, do not work alone; work with another person who can immediately turn off the power in an emergency.
- Do not wear any metallic item such as a wrist watch with a metallic surface, or metallic accessories.

If you wear eyeglasses with a metallic frame, take care not to let the frame touch an uninsulated surface.

- Make sure that your hands and arms are dry.
- Unless otherwise specifically instructed, use only one hand when it is necessary to work near an exposed live electric circuit.

This prevents the completion of the circuit through your heart even if you accidentally touch the circuit.

- Do not use a dental mirror near an exposed live electric circuit.

The mirror surface is conductive and can become hazardous even if it is made of plastic.

- Unless otherwise specifically instructed, do not supply power to any subassembly such as a power supply unit or a motor while it is removed from the machine.

## Procedures in an emergency

### For electric shock

- Do not panic. Do not become another victim through contact with the injured person.
- First, shut off the electric current passing through the victim.  
Use the emergency power-off switch, if there is one, or, otherwise, a normal power-off switch. If this cannot be done, push the victim away from the source of the electric current by using a nonconductive object such as a dry wooden stick.
- Then, call an ambulance.
- If the victim is unconscious, artificial respiration may be necessary.  
A proper method for performing artificial respiration or resuscitation should be learned beforehand. If the victim's heart is not beating, cardio-pulmonary resuscitation should be performed by a trained and qualified person.

### For outbreak of fire

- First, shut off all the power from the machine using the emergency power-off switch, if there is one, or the normal power-off switch.
- If the fire continues burning after the power is shut off, take suitable actions including the use of a fire extinguisher or a call for the fire department.



## 2. Hazard Warning Statements

The following are the hazard warning statements contained in this manual.

### 2.1 WARNING Statements

(chapter 3, page 3-5)

#### **WARNING**

- Switch off the power supply before making connections to the terminal block. Making connections with the power supply being switched on may incur electrical shock.
- In the event of electric shock, you may suffer burns or get electrocuted to death. Further, the system may malfunction due to noise interference. So, be sure to ground the line ground (LG), frame ground (FG), and shield wire (SHD).

### 2.2 NOTICE Statement

(chapter 1, page 1-9)

#### **NOTICE**

Users of this product must have an adequate knowledge of the Windows® environment and user interface. This system conforms to the Windows® standard, and this manual is prepared for those users who are familiar with the basic Windows® operating procedures.

(chapter 2, page 2-3)

#### **NOTICE**

- Be sure to operate the NA (Node Address), DR (Data Rate), and MODU No. switches while the D.NET module is powered off. If any of the switches is operated while it is ON, the normal operation of the D.NET module is not guaranteed.
- When mounting only one D.NET module in the CPU or LPU unit, be sure to set the MODU No. to "0".
- When mounting two or more D.NET modules in the CPU or LPU unit, be sure to set MODU No. equal to "0" for one of those modules.

(chapter 2, page 2-4)

### **NOTICE**

If you set any of the values 4 thru F shown above, the following warning will result:

- The D.NET module stops communication and the red MNS indicator comes on.
- In the S10mini, the CPU's indicator displays the characters "DN\* MDSW", where "\*" is a channel number of 0 to 3.

(chapter 3, page 3-2)

### **NOTICE**

S10mini series:

- Mount the option module in the option slot that is located to the immediate right of the CPU module. Be sure that no I/O modules are mounted between this option module and CPU module mounted. Also, ensure that there is no unoccupied slot between mounted option modules.
- This module (LQE570/575) can be mounted together with the LQE070/170/175 D.NET module, which is specially designed for use with the S10mini series.

When installing the LQE070 module containing a built-in microprogram of version-revision 1.0 (hereinafter referred to as LQE070 V1.0) together, set the MODU No. switch of that D.NET module to "0." Without this setting, the LQE070 V1.0 D.NET module cannot function normally.

S10V series:

- There are no specific rules about the mounting position and unoccupied slots.
- The LQE070/170/175 D.NET module cannot be used, as it is specially designed for use with the S10mini series.

Common rules for the S10mini series and S10V series:

- When installing only one D.NET module in place, be sure to set MODU No. to "0".
- When installing multiple D.NET modules in place, be sure to set the MODU No. of one of these modules to "0".

### NOTICE

- Dust or other foreign matter might accumulate on the connector, resulting in poor connection. Immediately after the module is unpacked, perform the mounting and wiring procedures.
- To prevent the module from being damaged, observe the following precautions when mounting or demounting the module:
  - Before mounting the module onto the mount base connector, check that the connector pins are properly aligned and not bent, broken, or soiled with dirt or the like.
  - When mounting it, ensure that the module's connection surface is parallel to the mount base's vertical surface, as shown below. If you connect the module to or disconnect it from its connector while it is tilted, the connector pins may be damaged.
  - If the mount base is positioned overhead because of the employed enclosure structure, use a stepladder or the like and mount the module squarely, not at an angle. If you mount it obliquely, the connector may be damaged.

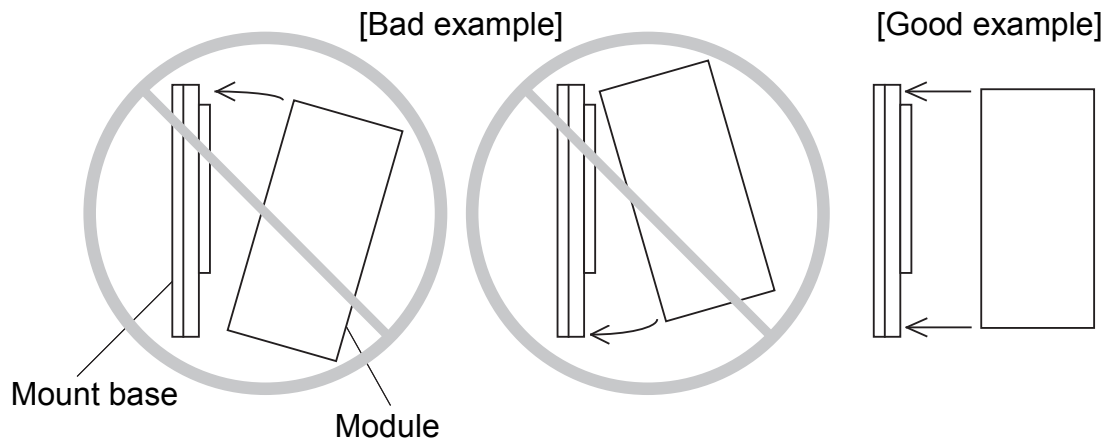

### NOTICE

- Electrically insulate the mount base from the enclosure. To accomplish this, never remove the insulation sheets supplied with the mount base.
- The LG is a grounding terminal for power supply noise. The FG and SHD are grounding terminals for the noise in the remote I/O communication module and other external interface lines. To prevent interference between the grounding terminals, separately ground the LG and FG.

(chapter 3, page 3-7)

### **NOTICE**

- Be sure to switch off the power to the S10mini or S10V controller, all connected DeviceNet devices, and the communications power supply before connecting the cable to the connector of the LQE570 or LQE575.
- The LQE570 self-feeds communications power and requires no external power supply. Further, its interior is separated from the power wiring, so no problem is caused by connecting a communication power supply to it.
- Check the cable connector periodically (every 3 to 6 months) for any loosened connector-fixing screw, and tightly screw the connector, if necessary.

(chapter 3, page 3-11)

### **NOTICE**

- Cables of the same type (e.g., communication cables) must not be intermingled with cables of other types (e.g., power cables and motor lead cables). Particularly, communication lines must be isolated at least 300 mm from lead cables from inverters, motors, power regulators, etc. Do not put communication cables and power cables together in the same pipe or conduit.
- Always use dedicated 5-wire communication cables conforming to the DeviceNet standard. Do not use any other cables for communication.
- Do not extend cables tautly between connecting points. Provide enough slack in connected cables for future re-wiring due to repairing or device movement.
- Do not clamp or tie cables tightly together. Clamp or tie the cables loosely so that you can easily move them later for adjustment. Applying an excessive force to cables may damage them.
- Do not yank the communication cable or pull it strongly. Exerting an excessive force on such a cable may cause disconnection or breakage of wire.
- Do not put a heavy object on the communication cable. Disregarding this rule may cause disconnection or breakage of wire.

(chapter 3, page 3-12)

### **NOTICE**

- Always use ferrules to connect wires of the communication cable to the plug-in screw connector. If such a cable is connected to the plug-in screw connector without using ferrules, it may be easily disconnected or broken.
- Do not extend cables tautly between connecting points. Provide enough slack in connected cables so as not to give an excessive force to the connectors.
- Connection of a node other than the D.NET does not always require an open type connector. For other companies' nodes, connect them with communication cables according to the manual for each node.
- Connect the signal wires, power wires, and the drain wire correctly to the connector. Note that the power wires of the thick cable require different ferrules than the other wires of the same cable.

(chapter 3, page 3-13)

### **NOTICE**

Each T-branch tap has holes for fixing it. After connecting the communication cables to the tap, secure the tap firmly with screws.

(chapter 3, page 3-14)

### **NOTICE**

When branching a cable via a TB, two wires need to be connected to a single terminal of that TB. In these cases, you must assure complete contact of the solderless terminals with the terminal of the TB. To accomplish this, face the two solderless terminals of the wires back to back on the block terminal and tighten the screw. If the solderless terminals are not faced back to back, an incomplete terminal contact may occur, resulting in a communication error.

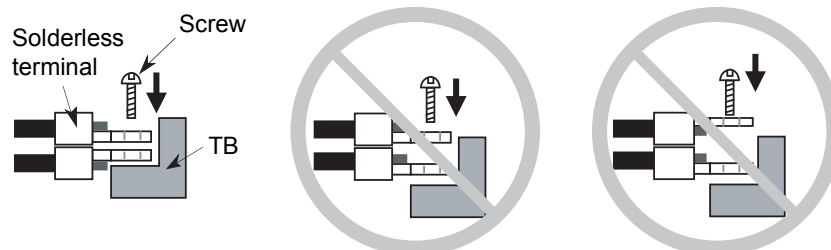

(chapter 3, page 3-15)

### **NOTICE**

When connecting a terminating resistor to a terminal block (TB), always connect it between the signal wires (CAN-H and CAN-L). If it is connected to other terminals, normal communication will not be possible.

(chapter 3, page 3-18)

### **NOTICE**

- Always use a communication power supply having overvoltage and overcurrent protecting functions.
- Make sure all the cables are connected correctly before switching on the power supply.
- Add a line filter to the primary side of the communication power supply.

(chapter 3, page 3-20)

### **NOTICE**

- Do not connect the ground wire to the drain terminal of the open-type connector that has a drain wire already connected as shown below.

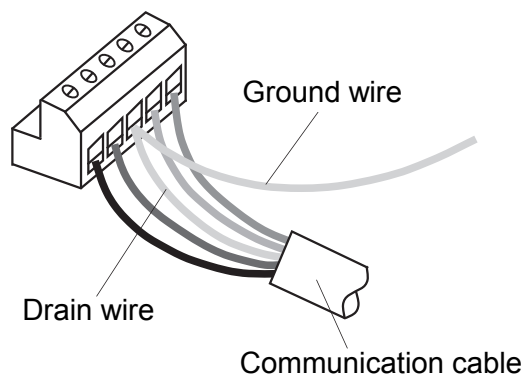

- Do not ground the communication cable and lead cables of inverters, motors, etc. to the same grounding point. If such grounding is done, power noise will be induced into the communication cable through the ground wire.

(chapter 3, page 3-27)

**NOTICE**

The LQE570 has communication power supplied by self-feeding, so no such power is included in the current consumption calculation. Further, this model allows the connection of a network power cable to it. This causes no problem because the power cable is not connected internally in the D.NET module.

(chapter 3, page 3-32)

**NOTICE**

If the power system is divided into two or more subsystems and a power supply is provided for each of the subsystems, do the same verification for each power supply to ensure that it can feed power to the given nodes.

(chapter 4, page 4-2)

**NOTICE**

- Be sure to operate the NA (Node Address), DR (Data Rate), and MODU No. setting switches while the D.NET module is powered off. If any of the switches is operated while the D.NET module is powered on, the D.NET module will get into trouble.
- When mounting only one D.NET module in the CPU or LPU unit, be sure to set its module number (MODU No.) to "0".
- When mounting two or more D.NET modules in the CPU or LPU unit, be sure to set the MODU No. of one of the modules to "0".

(chapter 4, page 4-3)

**NOTICE**

The D.NET system can be used only when the CPU or LPU unit is connected to the Windows® personal computer. You cannot set any parameters while the CPU or LPU unit is not connected to such a personal computer.

(chapter 4, page 4-11)

### **NOTICE**

- Users of this product must be familiar with the Windows® environment and user interface. The D.NET system is designed according to the Windows® standards, so this manual that comes with it is intended for those users whose are familiar with basics on how to use the Windows® operating system.
- If you want to use the D.NET system on a PC having suspend function, turn off the suspend function. If the suspend function comes into operation during the execution of the D.NET system, the D.NET system may malfunction.

(chapter 4, page 4-21)

### **NOTICE**

- If you want to set up two or more ports with their input and output byte counts set to a value greater than 8, care must be taken so as not to cause any overlap between the setups of those ports. For example, if the port No.9 is already set up with its output byte count set to “8”, the port No.8 cannot be set up with its input byte count set to a value greater than 8.
- No setup of a port can exceed the buffer memory limit of the last port (No./A0). For example, you cannot set up the last port with its input byte count set to a value greater than 8 (because it is limited to 8).

(chapter 4, page 4-25)

### **NOTICE**

- Only one communication type may be specified for any one single port.
- In master/slave communication, one slave uses 1 to 32 ports. Although a total of 160 port numbers are provided in the system, the maximum number of slaves that can be registered is 63 because the available MAC IDs are limited in number, which are /0 through /3F.



**NOTICE**

Although a total of 160 port numbers are provided in the system, the ports that can be allotted for a particular type of communication are limited as follows:

No.	Communication type	Maximum number of ports allottable
1	Peer transmission	16
2	Peer reception	144
3	Poll	63
4	Bit strobe transmission	1
5	Bit strobe reception	63

The total number of ports allotted must satisfy the following condition:

Peer transmission + Peer reception + Poll + Bit strobe transmission + Bit strobe reception  $\leq$  160

If an input/output byte count is set to a value greater than 8, two or more ports will be used. In this case, those ports must be counted as one port in the above calculation.

A port allotment limitation check is made by the D.NET system, so the user need not do it.

### **NOTICE**

- The input and output byte counts must always be specified. If you need not use them, set them to "0".
- Specify these parameters only in units of bytes.
- Even when the input/output byte count is set to "1", a 1-word area will be used in the CPU or LPU memory area defined by a specified input/output address pair.
- If the output byte count is set to a value greater than 8, the D.NET module will perform fragment transmission (split transfer). If the input byte count is set to a value greater than 8, the D.NET module will perform fragment reception. To put it more specifically, if the D.NET module is used in master mode, it first checks the maximum sizes of send data and receive data to be exchanged with a destination slave. Then, if it is found that the destination slave is not in need of a connection for "fragment transmission - fragment reception" or "non-fragment transmission - non-fragment reception," the D.NET module does not establish a connection with the destination slave. When this occurs, slave error information is generated that includes one of the following slave status values (see "4.9 Slave Error Information"):

/31 (which means that the produced connection size on the slave side supporting I/O Poll connections was found not matching the D.NET module)

/32 (which means that the consumed connection size on the slave side supporting I/O Poll connections was found not matching the D.NET module)

The non-establishment of a connection also occurs when the following condition is not met: maximum transmission data size  $\leq$  maximum reception data size. Also in this case, the generated slave error information includes one of the above slave status values.

If the D.NET module is used in peer mode, it does not check the data size. You must check the size of data to be exchanged with a destination device in advance.

(chapter 4, page 4-29)

**NOTICE**

- Do not use the bit reversal mode when connecting with a slave device (AI/AO) that handles analog data or other numeric data. If it is used, the input/output data will become undefined.
- Do not use the bit reversal mode when connecting with a slave device that handles both digital data and analog data. If it is used, the input/output data will become undefined.

(chapter 4, page 4-30)

**NOTICE**

- Any data area specified as the input/output area described under “4.5.3 D.Station data format conversion” is out of the scope of bit reversal processing even when the “Bit reversal mode” check box is selected. (The reason for this is that, even if “bit swap” is specified on the D.Station side, bit reversal is not performed for analog modules, including pulse counters.)
- If you want to establish a connection with the D.Station, ensure that the bit reversal mode and byte reversal mode settings made do not cause any conflict with the data swap setting made with the rotary switches on the D.Station side. For example, if a bit/byte swap setting is made on the D.Station side, check both of the bit reversal mode and byte reversal mode check boxes on the D.NET side.

(chapter 4, page 4-32)

**NOTICE**

- This setting item is applicable only when the communication destination party is a D.Station. If this item is selected for any destination party other than the D.Station, a connection is not established due to an error. This error condition can be identified under “4.9 Slave Error Information.” The slave status value in this case is 0x2F, which stands for a failure in acquisition of I/O status information.
- D.Station status information collection is performed only at the establishment of a connection with a D.Station. Accordingly, even if the D.Station’s status changes after the establishment of a connection, this status change is not reflected in the D.NET. If you want to monitor its status constantly, use the D.Station’s I/O error/mounting information-adding function, which adds status information to the input/output data. For details on the I/O error/mounting information adding function, refer to the HARDWARE MANUAL, D.Station (manual number SME-1-119).

(chapter 4, page 4-33)

**NOTICE**

Be sure to set “bit strobe transmission” as the communication type to use bit strobe communication. If only “bit strobe reception” is set, the D.NET module cannot transfer data to and from the slave. Setting only one port for bit strobe transmission enables data transfer to and from the slave.

(chapter 4, page 4-35)

**NOTICE**

If the communication kind is set to “No use”, all communication is disabled.

(chapter 4, page 4-36)

### **NOTICE**

- The input and output byte counts must always be specified. If you need not use them, set them to “0”.
- Specify these parameters only in units of bytes.
- Even when the input/output byte count is set to “1”, a 1-word area will be used in the CPU or LPU memory area defined by a specified input /output address pair.
- If the output byte count is set to a value greater than 8, the D.NET module will perform fragment transmission (spilt transfer). If the input byte count is set to a value greater than 8, the D.NET module will perform fragment reception.
- If the D.NET module is used in slave mode, it does not check the data size. You must check the size of data to be exchanged with the master in advance.

(chapter 4, page 4-37)

### **NOTICE**

Do not use the bit reversal mode when connecting with a master device that handles analog data or other numeric data. If it is used, the input/output data will become undefined.

(chapter 4, page 4-41)

### **NOTICE**

The timeout information as shown above is 1 or 2 words long, depending upon the number of remote I/O stations registered via the [RI/O timeout information collection station registration] window.

(chapter 4, page 4-43)

### **NOTICE**

- This function is applicable only in transmission (output) in slave mode. (It is not applicable in master-peer mode.)
- The output area in which timeout information is stored cannot be used as an input area for a remote I/O station.
- If the “Bit reversal mode” check box is checked, each word of timeout information is also bit-reversed.

(chapter 4, page 4-50)

### **NOTICE**

- The input/output area set by both an input/output address and an input/output byte count for format conversion must be within the range of the input/output area that has been set by both the input/output address pair and input/output byte count entered via the [Parameter edit] window for station parameter setting. If an attempt is made to set the former input/output area beyond the limits of the latter, the tool will report it as an out-of-range error and will not write the specified parameters to the D.NET module. In this case, you have to correct the parameters and retry writing.
- A total of 32 cases of format conversion can be registered, but the number of cases that can be registered per D.Station is limited to 8. If an attempt is made to register more than eight cases per D.Station, the tool will report it as a “too many cases for registration” error and will not write the specified parameters to the D.NET module. In this case, you have to correct the parameters and retry writing.
- If a specified module type is AI or AO (with or without a sign extension) and a specified input/output byte count is an odd number, then the count will be rounded up to the nearest even number, as exemplified below.  
Examples: If a byte count of 1 is specified, it is rounded up to 2.  
If a byte count of 3 is specified, it is rounded up to 4.

(chapter 4, page 4-92)

### **NOTICE**

You can add a comment to a file when saving the parameters to it. This comment, called a file comment, is limited to 128 characters in length.

(chapter 4, page 4-114)

### **NOTICE**

Before installing the D.NET, be sure to exit all the currently open Windows® programs. Do not forget to exit anti-virus software and other memory-resident programs. If you try to install the D.NET without exiting such programs, an error may occur during the installation. In this case, first uninstall the D.NET as directed in “4.17.2 Uninstalling the system,” exit all the Windows® programs, and then try it again.

(chapter 4, page 4-116)

**NOTICE**

- The S10V base system is required for the S10V D.NET to run normally. If the base system is not installed, install it. Without the base system, you cannot install the S10V D.NET.
- Before installing the S10V D.NET, be sure to exit all the currently open Windows® programs. Do not forget to exit anti-virus software and other memory-resident programs. If you install the S10V D.NET without exiting such programs, an error may occur during use. In this case, first uninstall the S10V D.NET as directed in “4.17.2 Uninstalling the system,” exit all the Windows® programs, and then install the S10V D.NET again.

(chapter 4, page 4-116)

**NOTICE**

If Windows® presents the “Remove Shared File?” dialog box during the uninstall process, click the  button to retain the shared file.

(chapter 5, page 5-3)

**NOTICE**

In this configuration, data is transferred word by word between the I/O area in the CPU or LPU and the I/O buffer in the D.NET system. Therefore, the unit of data transfer that can assure the simultaneousness of data is the word. However, to assure the simultaneousness of data in the whole configuration, including DeviceNet devices, the DeviceNet devices themselves must also ensure the simultaneousness of data.

(chapter 5, page 5-4)

### **NOTICE**

Each slave timeout flag is set (= "1") when no data is received from the slave device within a fixed time period. However, this is not the case when data cannot be transmitted normally due to the occurrence of a CAN transmission timeout or bus-off condition. The reason for this is that reception monitoring always starts upon the completion of a normal transmission. The occurrence of a CAN transmission timeout and bus-off condition can be confirmed by accessing the S-register described in "5.3 S-Register."

(chapter 5, page 5-5)

### **NOTICE**

The bus-off and CAN transmission timeout error bits are set to "0" (OFF) when the corresponding error conditions are cleared. Therefore, if the communication cable is damaged or the communication connector is connected incompletely, these bits may be set and reset repeatedly. Keep this in mind when referencing this register from a ladder program.

(chapter 5, page 5-8)

### **NOTICE**

- The set value of the refresh time must satisfy the following conditions:  
The number of transmission frames per 10 ms is 16 or less (at transfer speed of 500 or 250 kbps).  
The number of transmission frames per 10 ms is 8 or less (at transfer speed of 125 kbps).  
Number of transmission frames  
(if the number of output bytes is 8 or less) = 1  
(if the number of output bytes is 9 or more) = Number of output bytes ÷ 7  
(rounded up to integer)
- Be sure to set the refresh time to the obtained communication processing time or more. If this requirement is not satisfied, the D.NET's communication capacity is exceeded, resulting in a delay of the transmission cycle.



(chapter 5, page 5-14)

**NOTICE**

- The bit reversal mode can only be enabled for individual slaves separately.
- When the D.NET module is connected to a slave device (e.g., AI/AO) that handles numeric data such as analog data, do not enable the bit reversal mode for that slave device. If it is enabled, the I/O data will become undefined.
- Similarly, do not enable the bit reversal mode for a slave device that handles both analog and digital data. If it is enabled, the I/O data will become undefined.
- In the LQE570/575, the byte reversal mode has been added as its new feature. Basically, use D.NET modules of these models, with the byte reversal mode enabled. Disable the mode (by deselection) only when reversing the byte order.

(chapter 5, page 5-16)

**NOTICE**

Data swapping by the user is required only when the data is made up of bytes or long or longer words. In this case, it is required regardless of the number of data bytes to be input or output. For example, if data is transferred to and from a 4-channel AI slave (1 word/ channel), the number of input bytes is 8, but no data swapping is required because the data is transferred in words.

(chapter 5, page 5-18)

**NOTICE**

- The bit reversal and byte reversal modes need to be enabled or disabled, depending on the data handling of application programs and the specifications of connected devices.
- Any area set for D.Station data format conversion is invalid in bit conversion mode, where no bit conversion is performed.

(chapter 7, page 7-11)

**NOTICE**

In the S10mini, if the D.NET module's red MNS indicator lights up and the CPU module's indicator shows nothing, the D.NET module may be in failure. Replace the module.

(chapter 7, page 7-13)

**NOTICE**

A parameter error will occur if the D.NET module is mounted in a different machine model than the one under which parameters as shown in "4 OPERATION" have been set. Specifically, this is true with the following two cases:

Case 1: When the D.NET module whose parameters have been set for use under the S10V is installed in the S10mini, the message "DN\* PRM1" ("\*": MODU No.) is displayed on the CPU's indicator.

Case 2: When the D.NET module whose parameters have been set for use under the S10mini is installed in the S10V, the code 0x5189 is displayed in the error log information presented by the tool (S10V base system).

The above features are intended to prevent a malfunction due to a reference made to the parameters used under a different machine model.

A parameter error will also occur if a checksum error occurs in relation to the contents of the existing parameter settings. In this case, open the relevant parameter setting window under the machine model in which the D.NET module is mounted, and add a change to the existing parameter settings if necessary.

**This Page Intentionally Left Blank**

## WARRANTY AND SERVICING

Unless a special warranty contract has been arranged, the following warranty is applicable to this product.

### 1. Warranty period and scope

#### Warranty period

The warranty period for this product is for one year after the product has been delivered to the specified delivery site.

#### Scope

If a malfunction should occur during the above warranty period while using this product under normal product specification conditions as described in this manual, please deliver the malfunctioning part of the product to the dealer or Hitachi Engineering & Services Co., Ltd. The malfunctioning part will be replaced or repaired free of charge. If the malfunctioning is shipped, however, the shipment charge and packaging expenses must be paid for by the customer.

This warranty is not applicable if any of the following are true.

- The malfunction was caused by handling or use of the product in a manner not specified in the product specifications.
- The malfunction was caused by a unit other than that which was delivered.
- The malfunction was caused by modifications or repairs made by a vendor other than the vendor that delivered the unit.
- The malfunction was caused by a relay or other consumable which has passed the end of its service life.
- The malfunction was caused by a disaster, natural or otherwise, for which the vendor is not responsible.

The warranty mentioned here means the warranty for the individual product that is delivered. Therefore, we cannot be held responsible for any losses or lost profits that result from the operation of this product or from malfunctions of this product. This warranty is valid only in Japan and is not transferable.

### 2. Range of services

The price of the delivered product does not include on-site servicing fees by engineers. Extra fees will be charged for the following:

- Instruction for installation and adjustments, and witnessing trial operations.
- Inspections, maintenance and adjustments.
- Technical instruction, technical training and training schools.
- Examinations and repairs after the warranty period is concluded.
- Even if the warranty is valid, examination of malfunctions that are caused by reasons outside the above warranty scope.

**This Page Intentionally Left Blank**

This manual provides information on the following hardware and program products:

<Hardware product>

D.NET (LQE570/575)

<Program products>

S-7890-31, D.NET SYSTEM, 07-04

S-7895-31, S10V D.NET SYSTEM, 01-04

## Revision record

Revision No.	Revision record (revision details and reason for revision)	Month, Year	Remarks
B	First edition	March 2003	
F	Subsection 7.1.2, “Replacing or adding on the module” is newly added.	October 2008	
G	An additional item of information (“Slave parameter setting”) is added to Table 4-1 in “1.4 Points of Difference from Conventional Modules.” Section 4.6, “Setting Slave Parameters” is newly added. Subsection 4.14.2, “Selecting a slave parameter setting file” is newly added.	November 2008	
H	<ul style="list-style-type: none"><li>• All the safety precautions and instructions in this manual have been reviewed and necessary changes are added to them.</li><li>• Windows® 7 (32-bit) operating system is newly supported.</li></ul>	November 2012	

In addition to the above changes, all the unclear descriptions and typographical errors found are also corrected without prior notice.

## PREFACE

Thank you for purchasing the D.NET module, which is an option provided for use with the S10mini/S10V controller.

This manual, named USER'S MANUAL, OPTION D.NET, describes how to use the D.NET module. For proper use of the D.NET module, the reader is requested to read this manual thoroughly.

The S10mini and S10V products are available in two types: standard model and environmentally resistant model. The environmentally resistant model has thicker platings and coatings than those of the standard model.

The model number of the environmentally resistant model is marked by adding the suffix "-Z" to the model number of the standard model.

Example: Standard model: LQE570

Environmentally resistant model: LQE570-Z

This manual is applicable to both the standard model and environmentally resistant model.

Although the descriptions contained in this manual are based on the standard model, follow the instructions set forth in this manual for proper use of the product even if you use the environmentally resistant model.

### <Trademarks>

- Microsoft® Windows® operating system, Microsoft® Windows® 95 operating system, Microsoft® Windows® 98 operating system, Microsoft® Windows® 2000 operating system, Microsoft® Windows® XP operating system, Microsoft® Windows® 7 (32-bit) operating system are registered trademarks of Microsoft Corporation in the United States and/or other countries.
- DeviceNet is a registered trademark of ODVA (Open DeviceNet Vendor Association, Inc.)

### <Note for storage capacity calculations>

- Memory capacities and requirements, file sizes and storage requirements, etc. must be calculated according to the formula  $2^n$ . The following examples show the results of such calculations by  $2^n$  (to the right of the equals signs).

1 KB (kilobyte) = 1,024 bytes

1 MB (megabyte) = 1,048,576 bytes

1 GB (gigabyte) = 1,073,741,824 bytes

- As for disk capacities, they must be calculated using the formula  $10^n$ . Listed below are the results of calculating the above example capacities using  $10^n$  in place of  $2^n$ .

1 KB (kilobyte) = 1,000 bytes

1 MB (megabyte) = 1,000<sup>2</sup> bytes

1 GB (gigabyte) = 1,000<sup>3</sup> bytes



# CONTENTS

1	SPECIFICATIONS .....	1-1
1.1	Application.....	1-2
1.2	Specifications .....	1-2
1.2.1	System specifications .....	1-2
1.2.2	Communications specifications.....	1-3
1.2.3	Types of communication .....	1-4
1.3	System Software Specifications.....	1-8
1.3.1	System overview.....	1-8
1.3.2	Required hardware and software .....	1-9
1.4	Points of Difference from Conventional Modules.....	1-10
2	NAMES AND FUNCTIONS OF EACH PART.....	2-1
2.1	Names and Functions of Each Part .....	2-2
3	MOUNTING AND WIRING.....	3-1
3.1	Mount Base .....	3-2
3.2	Mounting the Module.....	3-2
3.3	Ground Wiring .....	3-4
3.4	Wiring .....	3-6
3.4.1	Interface signals and wiring.....	3-6
3.4.2	Hardware configuration.....	3-8
3.4.3	Components.....	3-10
3.4.4	Restriction of cable lengths .....	3-21
3.4.5	Consideration on the location of a communication power supply .....	3-25
3.4.6	Grounding specification .....	3-33
3.4.7	Precautions for use in an electromagnetic noise environment .....	3-34
4	OPERATION .....	4-1
4.1	Before Starting Up the System.....	4-2
4.1.1	System configuration.....	4-2
4.2	Starting Up the System.....	4-3
4.2.1	Procedure to start up the D.NET system .....	4-3
4.2.2	Function organization of the D.NET system .....	4-4
4.2.3	Starting up the D.NET system.....	4-7
4.3	Change of Connection with PCs .....	4-12
4.4	Channel and Operation Mode Selection .....	4-14

4.5	Setting Parameters.....	4-16
4.5.1	System parameter setting.....	4-16
4.5.2	Station parameter setting.....	4-21
4.5.3	D.Station data format conversion.....	4-44
4.6	Setting Slave Parameters.....	4-54
4.6.1	Procedure for setting slave parameters.....	4-54
4.6.2	Slave parameter setting.....	4-56
4.6.3	Items displayed in the [Setup slave parameters] window.....	4-59
4.6.4	Operating the [Setup slave parameters] window.....	4-60
4.7	S-Table (Communication Error) Information.....	4-83
4.8	Hard Error Information.....	4-85
4.9	Slave Error Information.....	4-87
4.10	Refresh Time Log Information.....	4-90
4.11	F/D Function.....	4-92
4.11.1	Save.....	4-93
4.11.2	Send.....	4-96
4.11.3	Compare.....	4-99
4.12	DeviceNet Serial No.....	4-104
4.13	Version Information.....	4-105
4.14	Selecting an Edition File.....	4-106
4.14.1	Selecting a D.NET file.....	4-106
4.14.2	Selecting a slave parameter setting file.....	4-108
4.15	Printing.....	4-110
4.16	CSV Output.....	4-112
4.17	Installing and Starting Up the System.....	4-114
4.17.1	Installing the system.....	4-114
4.17.2	Uninstalling the system.....	4-116
4.17.3	Starting up the system.....	4-117
4.17.4	Shutting down the system.....	4-117
5	PROGRAMMING.....	5-1
5.1	Software Configuration of the D.NET System.....	5-2
5.2	Slave Timeout Flags.....	5-4
5.3	S-Register.....	5-5
5.4	Communication Processing Time.....	5-6
5.5	CPU Load Ratio.....	5-9
5.6	Response Time of the D.NET Module in Slave Mode.....	5-10
5.7	Parameter Settings Required for Other Company's DeviceNet Devices Connected.....	5-11

5.7.1	Caution when disabling the bit reversal mode.....	5-12
5.7.2	Caution when enabling the bit reversal mode .....	5-13
5.7.3	Handling analog data .....	5-15
5.7.4	Data reversal modes.....	5-17
5.8	CPU or LPU Module Switch Settings and D.NET Module Operation.....	5-19
6	INSTALLATION WORK ASSISTANCE .....	6-1
6.1	Installation Work Check List .....	6-2
7	MAINTENANCE.....	7-1
7.1	Maintenance and Checks.....	7-2
7.1.1	Periodic checks .....	7-2
7.1.2	Replacing or adding on the module.....	7-3
7.2	Troubleshooting .....	7-6
7.2.1	Procedure .....	7-6
7.2.2	Preliminary checking.....	7-7
7.3	Errors and Remedial Actions .....	7-10
7.3.1	Indications on the CPU module's indicator.....	7-10
7.3.2	Error indications and required actions.....	7-11
7.4	Problem Report .....	7-14

## FIGURES

Figure 1-1	Polling Communication in Master Mode .....	1-4
Figure 1-2	Bit Strobe Communication in Master Mode .....	1-5
Figure 1-3	Polling Communication in Slave Mode .....	1-6
Figure 1-4	Peer-to-Peer Communication in Peer Mode.....	1-6
Figure 2-1	MNS LEDs Immediately After Power ON .....	2-5
Figure 3-1	Mounting the Option Module.....	3-3
Figure 3-2	Ground Wiring .....	3-4
Figure 3-3	Interface Signals and Wiring of LQE570 and LQE575 .....	3-6
Figure 3-4	DeviceNet Hardware Configuration Example .....	3-8
Figure 3-5	Communication Cable.....	3-10
Figure 3-6	Bending Radius of the Cable.....	3-10
Figure 3-7	Connector .....	3-12
Figure 3-8	T-branch Taps .....	3-13
Figure 3-9	Terminal Block.....	3-14
Figure 3-10	Terminating Resistor .....	3-15
Figure 3-11	Connecting a Power Cable by Power Tap.....	3-16
Figure 3-12	Disconnecting a Power Wire by Power Tap .....	3-17
Figure 3-13	Connecting and Disconnecting Power Wires by Terminal Block.....	3-17
Figure 3-14	Ground Wire Leading-out Method (1).....	3-19
Figure 3-15	Ground Wire Leading-out Method (2).....	3-20
Figure 3-16	Maximum Network Length.....	3-21
Figure 3-17	Branch Cable Lengths .....	3-22
Figure 3-18	Total Branch Cable Length .....	3-23
Figure 3-19	Allowable Power Supply Capacity .....	3-25
Figure 3-20	“Trunk Cable Length vs. Maximum Current” for Thick Cables.....	3-28
Figure 3-21	“Trunk Cable Length vs. Maximum Current” for Thin Cables .....	3-28
Figure 3-22	Example of a Power Supply and Nodes Connection for Method 1 .....	3-29
Figure 3-23	Voltage Drops .....	3-30
Figure 3-24	Example of a Power Supply and Nodes Connection for Method 2 .....	3-32
Figure 3-25	Grounding Specification – an Example .....	3-33
Figure 4-1	System Configuration.....	4-2
Figure 4-2	Channel Selection Dialog Box .....	4-7
Figure 4-3	The D.NET System’s Main Window .....	4-7
Figure 4-4	[Communication type] Window.....	4-8
Figure 4-5	The Module/Channel Selection Window -- an Example .....	4-8

Figure 4-6	The Error Message Dialog Box Reporting on an Intermingled 1-Ch and 2-Ch D.NET Modules Installation .....	4-9
Figure 4-7	The Error Message Dialog Box Reporting on an Attempt to Use Channels 0 and 1 in Different Modes.....	4-9
Figure 4-8	Selecting the [Offline] Radio Button .....	4-10
Figure 4-9	Selecting the Edition File You Want to Edit.....	4-10
Figure 4-10	Channel Selection Dialog Box .....	4-12
Figure 4-11	Module/Channel Selection Dialog Box.....	4-12
Figure 4-12	Channel Selection Dialog Box .....	4-14
Figure 4-13	Module/Channel Selection Dialog Box.....	4-14
Figure 4-14	The D.NET System's Basic Window.....	4-15
Figure 4-15	The D.NET System's Basic Window.....	4-15
Figure 4-16	The D.NET System's Basic Window.....	4-16
Figure 4-17	The [Setup system parameters] Window (master-peer mode).....	4-17
Figure 4-18	The [Setup system parameters] Window (master-peer mode).....	4-17
Figure 4-19	The [Setup system parameters] Window (slave mode).....	4-19
Figure 4-20	The [Setup system parameters] Window (slave mode).....	4-19
Figure 4-21	The [Setup system parameters] Window (master-peer mode).....	4-22
Figure 4-22	The [Setup station parameters] Window (master-peer mode) .....	4-22
Figure 4-23	The [Setup station parameters] Window (master-peer mode) .....	4-23
Figure 4-24	The [Parameter edit] Window 1 .....	4-24
Figure 4-25	The [Parameter edit] Window 2 .....	4-24
Figure 4-26	The [Setup system parameters] Window (master-peer mode).....	4-32
Figure 4-27	The [Setup system parameters] Window (slave mode).....	4-34
Figure 4-28	The [Setup station parameters] Window (slave mode) .....	4-34
Figure 4-29	The [Setup station parameters] Window (slave mode) .....	4-35
Figure 4-30	The [Setup system parameters] Window (slave mode).....	4-38
Figure 4-31	A Hardware Configuration Using the Remote I/O Timeout Information Collection Function .....	4-39
Figure 4-32	The Operation of the Remote I/O Timeout Info Collection Function.....	4-40
Figure 4-33	The [RI/O Timeout information collection station registration] Window .....	4-42
Figure 4-34	The [Station No. Registration] Window .....	4-42
Figure 4-35	The [Setup system parameters] Window (master-peer mode).....	4-46
Figure 4-36	The [Convert data format of D.STATION] Window.....	4-46
Figure 4-37	The [Convert data format of D.STATION] Window.....	4-47
Figure 4-38	The [Setup data format conversion of D.STATION] Window .....	4-47
Figure 4-39	The [Setup data format conversion of D.STATION] Window .....	4-48
Figure 4-40	A Configuration Using D.Station Data Format Conversion .....	4-51

Figure 4-41	The D.NET System’s Basic Window Displayed in Online Mode .....	4-56
Figure 4-42	The D.NET System’s Basic Window Displayed in Offline Mode .....	4-56
Figure 4-43	The [Setup slave parameters] Window (Displayed in Online Mode) .....	4-57
Figure 4-44	A Warning Message Dialog Box Displayed When All of the Module No., D.NET Type, and Channel No. Are Found Different between the Two.....	4-58
Figure 4-45	A Confirmation Message to Confirm You Want to Stop I/O Communication .....	4-60
Figure 4-46	The [Setup slave parameters] Window Displayed in Offline Mode .....	4-60
Figure 4-47	The Slave Parameter Setting File Selection Window .....	4-61
Figure 4-48	A Confirmation Message to Confirm You Want to Create a Slave Parameter Setting File .....	4-61
Figure 4-49	A Warning Message Dialog Box Displayed When All of the Module No., D.NET Type, and Channel No. Are Found Different between the Two.....	4-62
Figure 4-50	The [Save As] Window .....	4-63
Figure 4-51	The [For another module] Window.....	4-64
Figure 4-52	A Confirmation Dialog to Confirm Whether or Not You Are Saving the Slave Parameter Setting File .....	4-65
Figure 4-53	A Confirmation Dialog to Confirm Whether or Not You Want to Start I/O Communication.....	4-66
Figure 4-54	The [Print/CSV Output] Window .....	4-67
Figure 4-55	The MAC ID Error Message Dialog Box .....	4-67
Figure 4-56	The “Slave Parameters Undefined” Error Message Dialog Box.....	4-68
Figure 4-57	The [Print] Dialog Box.....	4-68
Figure 4-58	The [Save As] Dialog Box .....	4-69
Figure 4-59	The [Edit slave parameters] Window.....	4-70
Figure 4-60	The [Copy of slave parameters] Window .....	4-72
Figure 4-61	A Confirmation Dialog to Confirm Whether or Not You Are Overwriting the Slave Parameters with New Values.....	4-72
Figure 4-62	A Confirmation Dialog to Confirm Whether or Not You Are Deleting the Slave Parameters.....	4-73
Figure 4-63	A Confirmation Dialog to Confirm Whether or Not You Are Downloading the Slave Parameters.....	4-73
Figure 4-64	The Download Progress Window .....	4-73
Figure 4-65	The End-of-Download Window.....	4-74
Figure 4-66	The Download Failure Message.....	4-74
Figure 4-67	A Confirmation Dialog to Confirm Whether or Not You Are Uploading the Slave Parameters .....	4-76
Figure 4-68	The Upload Progress Window .....	4-76

Figure 4-69	The End-of-Upload Window.....	4-76
Figure 4-70	A Confirmation Dialog to Confirm Whether or Not You Are Comparing the Result of Your Editing with the Set Parameter Values.....	4-77
Figure 4-71	The Comparison Progress Window.....	4-77
Figure 4-72	The End-of-Comparison-with-Difference-Found Message.....	4-77
Figure 4-73	The [Compare] Window.....	4-78
Figure 4-74	The [Slave reset] Window.....	4-79
Figure 4-75	The Slave Connection Request Window.....	4-79
Figure 4-76	A Confirmation Dialog to Confirm Whether or Not You Are Downloading the Separate Sets of Slave Parameters to the Slave Devices Currently in “Connection” State.....	4-80
Figure 4-77	The Download-to-All Progress Window.....	4-80
Figure 4-78	A “Download-to-All Canceled” Message.....	4-80
Figure 4-79	The End-of-Download-to-All Window.....	4-81
Figure 4-80	A Confirmation Dialog to Confirm Whether or Not You Are Uploading the Separate Sets of Slave Parameters from the Slave Devices Currently in “Connection” State.....	4-81
Figure 4-81	The Upload-to-All Progress Window.....	4-81
Figure 4-82	An “Upload-to-All Canceled” Message.....	4-82
Figure 4-83	The End-of-Upload-to-All Window.....	4-82
Figure 4-84	The D.NET System’s Basic Window 1.....	4-83
Figure 4-85	The D.NET System’s Basic Window 2.....	4-83
Figure 4-86	CAN Transmission Timeout Error 1.....	4-84
Figure 4-87	CAN Transmission Timeout Error 2.....	4-84
Figure 4-88	The [Initial diagnostic error information] Window 1.....	4-85
Figure 4-89	The [Initial diagnostic error information] Window 2.....	4-86
Figure 4-90	The [Slave error information] Window 1.....	4-87
Figure 4-91	The [Slave error information] Window 2.....	4-88
Figure 4-92	The [Log information of refresh time] Window 1.....	4-90
Figure 4-93	The [Log information of refresh time] Window 2.....	4-91
Figure 4-94	The [Save As] Window.....	4-93
Figure 4-95	The [Receive file] Window.....	4-94
Figure 4-96	The File Reception Abortion Message Dialog Box.....	4-94
Figure 4-97	The File Reception Completion Message Dialog Box.....	4-95
Figure 4-98	The [Open] Window.....	4-96
Figure 4-99	The [Open] Window (displayed when a file is selected).....	4-97
Figure 4-100	The [Send file] Window.....	4-97
Figure 4-101	The PCs Reset Confirmation Message Dialog Box.....	4-98

Figure 4-102	The End-of-Transmission Message Dialog Box .....	4-98
Figure 4-103	The [Open] Window.....	4-99
Figure 4-104	The [Open] Window (displayed when a file is selected).....	4-100
Figure 4-105	The [Compare file] Window .....	4-100
Figure 4-106	The End-of-Comparison with No Difference Found Message .....	4-101
Figure 4-107	The [Memory Contents] Windows showing a Difference .....	4-102
Figure 4-108	The End-of-Comparison Message Reporting a Further Difference.....	4-103
Figure 4-109	The [DeviceNet serial No.] Window 1.....	4-104
Figure 4-110	The [DeviceNet serial No.] Window 2.....	4-104
Figure 4-111	[Open] Window -- an Example .....	4-106
Figure 4-112	[Creation confirmation] Dialog Box .....	4-107
Figure 4-113	Error Message Dialog Box Reporting on an Invalid D.NET Setup Info File Specified.....	4-107
Figure 4-114	The [Open] Window with a Slave Parameter Setting File Selected .....	4-108
Figure 4-115	A Confirmation Dialog to Confirm Whether or Not You Are Creating a New Slave Parameter Setting File .....	4-109
Figure 4-116	[Print] Dialog Box.....	4-110
Figure 4-117	[Save As] Dialog Box .....	4-112
Figure 4-118	Channel Selection Window.....	4-117
Figure 4-119	Module/Channel Selection Window .....	4-117
Figure 5-1	Software Configuration of the D.NET System .....	5-2
Figure 5-2	Finding the Communication Processing Time.....	5-8
Figure 5-3	A Graphical Representation of the Response Time in Slave Mode.....	5-10



## TABLES

Table 1-1	Communication Modes and Required Settings.....	1-7
Table 1-2	Mode Combinations and Required Settings.....	1-7
Table 1-3	Types of System Software (Tools).....	1-8
Table 1-4	Points of Difference from Conventional Modules.....	1-10
Table 1-5	Version-Revisions of the Microprogram .....	1-11
Table 2-1	Relationships between NA (Node Address) Values (in hexadecimal) and MAC IDs (in decimal).....	2-3
Table 2-2	Allowable Set Values of the MODU No. Setting Switch .....	2-4
Table 2-3	Indications of the MNS LEDs and Their Meanings.....	2-5
Table 3-1	Mount Bases for the D.NET Module .....	3-2
Table 3-2	Recommended Component Parts .....	3-9
Table 3-3	Communication Power Supply Specifications.....	3-18
Table 3-4	Cable Types and Network Transfer Rates .....	3-21
Table 3-5	Transfer Rates and Total Branch Cable Lengths .....	3-23
Table 3-6	Specifications of the Communication Cables .....	3-24
Table 3-7	Recommended Cable Models .....	3-24
Table 3-8	Thick-Cable Trunk Lengths and Maximum Currents.....	3-28
Table 3-9	Thin-Cable Trunk Lengths and Maximum Currents.....	3-28
Table 4-1	Slave Status Values .....	4-89
Table 4-2	Save Areas for Module and Channel Numbers.....	4-93
Table 4-3	Addresses at which Differences Are Found during Comparison by the F/D Function.....	4-103
Table 5-1	Memory Areas Usable as the I/O Area .....	5-3
Table 5-2	I/O Devices and Required Reversal Mode Settings.....	5-11
Table 7-1	Periodic Checks.....	7-2
Table 7-2	Factors that Make the D.NET Module Unable to Communicate.....	7-7
Table 7-3	Indications on the CPU Module's Indicator in the S10mini .....	7-10
Table 7-4	Error Indications and Required Actions.....	7-11
Table 7-5	Extension Error Codes (Network Errors) and Required Actions.....	7-12

# 1 SPECIFICATIONS

# 1 SPECIFICATIONS

---

## 1.1 Application

The D.NET module (model LQE570 or LQE575) conforms to the DeviceNet standard and performs data communications with various types of DeviceNet devices connected to the network as master modules, peer modules, or slave modules, each determined in its type by setting. When using this module (LQE570 or LQE575) in the S10mini CPU unit, it may coexist with S10mini-dedicated D.NET modules (LQE070, LQE170, or LQE175). (In the S10V LPU unit, however, none of the models LQE070, LQE170, and LQE175 can be used).

## 1.2 Specifications

### 1.2.1 System specifications

Item	Specifications
Models	LQE570, LQE575
Number of networks	1 per module
Maximum number of modules mountable	S10mini: 4 per CPU (each installed in the CPU unit, starting from the leftmost slot, without leaving any empty slot in between) S10V: 4 per LPU (each installed in any slot in the LPU unit)
Mass	230 g

1.2.2 Communications specifications

Item		Specifications		
Model		LQE570	LQE575	
MAC layer	Transmission path access	CSMA/NBA (Carrier Sense Multiple Access with Non-destructive Bitwise Arbitration)		
	Protocol	CAN (Control Area Network) protocol Supporting master/slave communication and peer-to-peer communication (*)		
Physical layer	Maximum number of nodes connectable	64 per network		
	Transmission speed	Variable (selected from among 125, 250, and 500 kbps)		
	Transmission size	Master/slave communication (Poll) and peer-to-peer communication: Up to 256 bytes per transmission Master/slave communication (Bit Strobe): Up to 8 bytes per transmission		
	Coding method	NRZ (Non Return to Zero)		
	Insulation	Photocoupler, 500 V		
	Communication power	24 VDC (see Table 3-3, "Communication Power Supply Specifications")		
	Communication power supply	Self-feeding	External power feeding	
	Transmission medium	Connector	Open plug connector	
		TAP	Open-type TAP and shield-type TAP	
		Cables	Trunk line: 5-wire thick cable Total length (variable according to the transmission speed): 500 m at 125 kbps 250 m at 250 kbps 100 m at 500 kbps	
			Drop line: Up to 6 m per branch line; 5-wire thin cable Total length of branch lines: 156 m at 125 kbps 78 m at 250 kbps 39 m at 500 kbps	
Power line: 3 m max.				
Terminator (terminating resistor)	Connectorcontaining a terminating resistor; or 121-Ω ± 1% (1/4 W or more) metal film resistor			

(\*) List of supported features

DeviceNet features			
Device type: Communication adapter		Master/Scanner	Supported
Explicit peer-to-peer messaging	Supported	I/O slave messaging	
I/O peer-to-peer messaging	Supported	• Bit strobe	Supported
Configuration consistency value	Not supported	• Polling	Supported
Faulted node recovery	Not supported	• Cyclic	Not supported
Baud rates 125k, 250k, 500k	Supported	• Change of state (COS)	Not supported

# 1 SPECIFICATIONS

---

## 1.2.3 Types of communication

### (1) Communications in master mode

#### (a) Polling communication

Polling communication is a type of I/O communication in which the master sends communication requests in sequence to a slave and the slave sends responses back to it. The master transmits a polling request to each slave at preset time intervals to exchange control data with the slave. The slave is not allowed to send data until a polling request comes from the master. By using a polling request, the master sends control data to the slave. Similarly, by using a polling response, the slave sends control data back to the master.

The polling communication is automatically carried out at regular intervals of a master/slave refresh time set by the D.NET system (see “4 OPERATION”).

Therefore, it need not be started from a user application program.

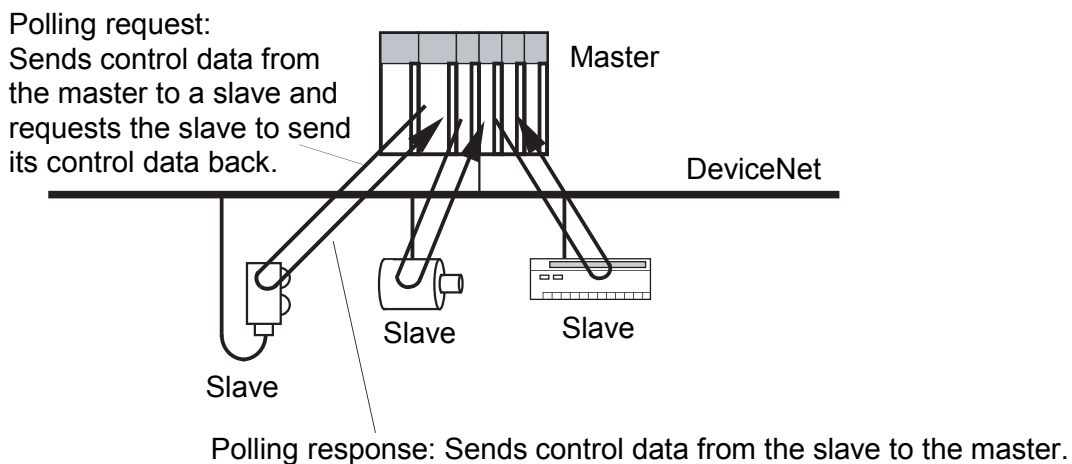

Figure 1-1 Polling Communication in Master Mode

## (b) Bit strobe communication

Bit strobe communication is a type of I/O communication in which the master sends a single Bit Strobe request to a user-specified number of slaves and more than one slave sends a Bit Strobe response back to it. This is a one-to-many query communication. The master transmits a single Bit Strobe request to each given slave at preset time intervals, and the slave is not allowed to send data until a Bit Strobe request comes from the master. By using a Bit Strobe request, the master sends control data to the slave. Similarly, by using a Bit Strobe response, the slave sends control data back to the master.

The bit strobe communication is automatically carried out at regular intervals of a master/slave refresh time set by the D.NET system (see “4 OPERATION”).

Therefore, it need not be started from a user application program.

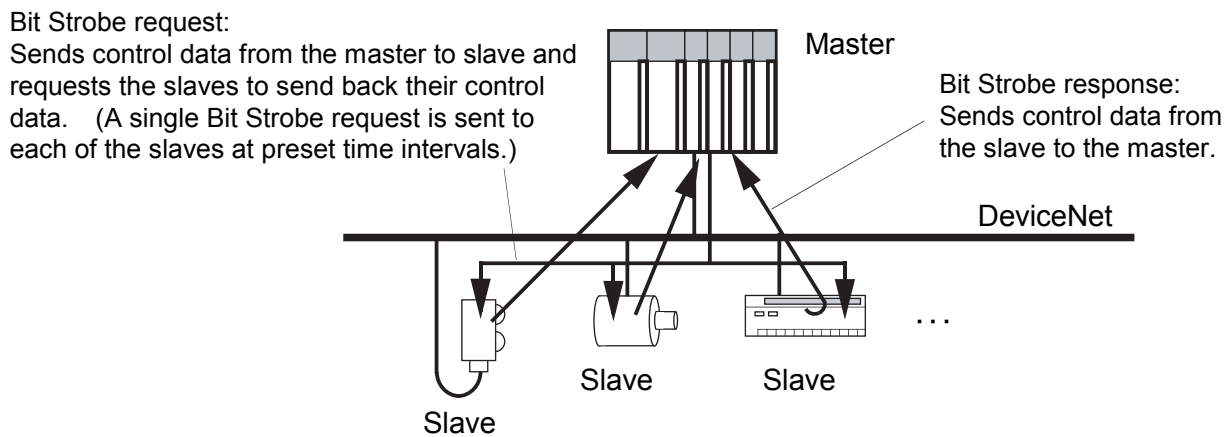

Figure 1-2 Bit Strobe Communication in Master Mode

# 1 SPECIFICATIONS

## (2) Communications in slave mode

### (a) Polling communication

In this communication, the D.NET module working as a slave transmits control data to and receives it from a master D.NET module or other manufacturer's master module. The slave D.NET module automatically sends data back to the master in response to a polling request from that master. Therefore, this transmission need not be started from a user application program. The slave D.NET module supports only polling communications.

Polling request:

Sends control data from the master to a slave and requests the slave to send back its control data.

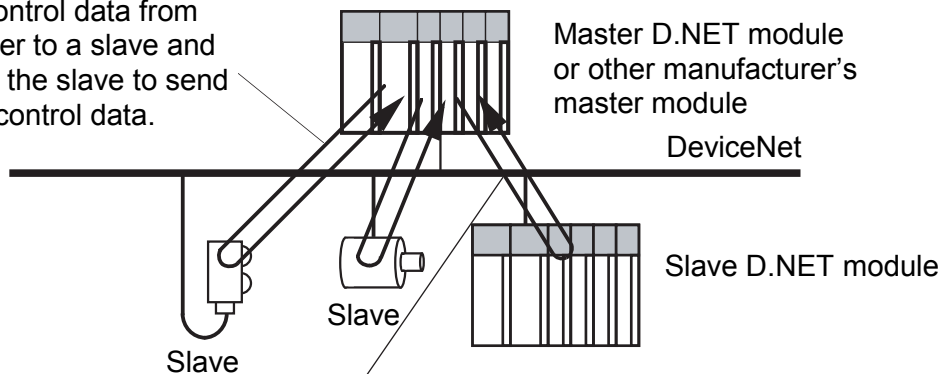

Polling response: Sends control data from the slave to the master.

Figure 1-3 Polling Communication in Slave Mode

## (3) Communications in peer mode

In peer mode, a sending peer broadcasts control data together with a message ID at preset time intervals. A receiving peer selectively receives the data according to that message ID and the sender MAC ID. Only the nodes supporting peer-to-peer communication can receive the transmitted data.

The peer-to-peer communication is automatically carried out at regular intervals of a peer refresh time set by the D.NET system (see "4 OPERATION"). Therefore, it need not be started from a user application program.

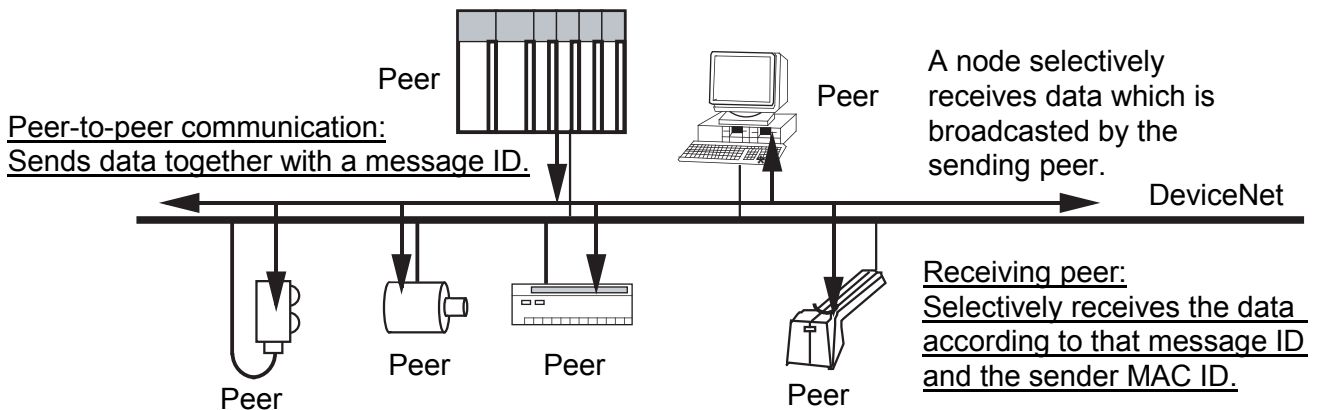

Figure 1-4 Peer-to-Peer Communication in Peer Mode

## (4) Communication modes and required settings for the D.NET system

When using any of the communication modes described above, set the corresponding operation mode and “Communication type” system parameter in the D.NET system, as shown below. (For information on how to set them, see “4 OPERATION.”)

Table 1-1 Communication Modes and Required Settings

Communication mode used		Operation mode	Communication type
Master mode	Polling communication	Master-peer mode	Poll
	Bit strobe communication		Bit strobe transmission Bit strobe reception
Slave mode	Polling communication	Slave mode	Poll
Peer mode		Master-peer mode	Peer transmission Peer reception

## (5) Allowable combinations of communication modes

The D.NET module can work in any of the master, slave, and peer modes and their allowable combinations, which are limited to “master - peer” and “slave - slave”. Mode combinations of “master - slave” and “peer - slave” may not be used with the D.NET module. Choose the desired mode combination and set the corresponding operation mode for the D.NET system, as shown below. (For information on how to set them, see “4 OPERATION.”)

Table 1-2 Mode Combinations and Required Settings

Mode combination	Operation mode set in the D.NET system
Master - peer	Master-peer
Slave - slave	Slave



# 1 SPECIFICATIONS

## 1.3 System Software Specifications

### 1.3.1 System overview

To use the D.NET module, you must register various items of module information in the module. This can be accomplished by using the system software (tools) listed below. The operating procedures for these tools are similar to those for general Windows® applications. The D.NET system for S10V controllers supports 1-channel and 2-channel D.NET modules (version-revision 01-01 or later), but the D.NET system for S10mini controllers only supports 1-channel D.NET modules.

For more information about the 2-channel D.NET module, refer to the USER'S MANUAL, OPTION D.NET (LQE770/775) (manual number SVE-1-129).

Table 1-3 Types of System Software (Tools)

Package name	Module model	Model		Supply style
		For S10mini	For S10V	
		S-7890-31	S-7895-31	
D.NET system	LQE070 (1ch-D.NET)	√	ns	Option
	LQE170/175 (1ch-D.NET)	√	ns	
	LQE570/575 (1ch-D.NET)	√	√	
	LQE770/775 (2ch-D.NET)	ns	√	

√: Supported

ns: Not supported

### 1.3.2 Required hardware and software

The following hardware and software items are required for the use of the D.NET module system software:

(1) For S10mini

- Personal computer (main unit) containing a Pentium 133 MHz or faster CPU
- Personal computer (main unit) containing a Pentium 300 MHz or faster CPU (when Windows® 2000 or Windows® XP is used)
- Display having a resolution of 800 × 600 dots (SVGA) or higher
- Microsoft® Windows® 95 operating system, Microsoft® Windows® 98 operating system, Microsoft® Windows® 2000 operating system or Microsoft® Windows® XP operating system
- Microsoft® Internet Explorer 4.01 or later
- At least 32 MB of RAM
- At least 64 MB of RAM (when Windows® 2000 is used)
- At least 128 MB of RAM (when Windows® XP is used)
- At least 10 MB of free hard disk space
- Cable for connecting the personal computer to the CPU unit (RS-232C cross cable with D-sub 9-pin connectors) or cable for connecting the personal computer to the ET.NET module (10BASE-T twisted pair cross cable with RJ-45 modular connectors)

(2) For S10V

- Personal computer (main unit) containing a Pentium 300 MHz or faster CPU, or a 1 GHz or faster CPU (when Windows® 7 (32-bit version) is used)
- Display having a resolution of 800 × 600 dots (SVGA) or higher
- Microsoft® Windows® 2000 operating system, Microsoft® Windows® XP operating system or Microsoft® Windows® 7 (32-bit) operating system
- At least 64 MB of RAM (when Windows® 2000 is used)
- At least 128 MB of RAM (when Windows® XP is used)
- At least 1 GB of RAM (when Windows® 7 (32-bit) is used)
- At least 10 MB of free hard disk space
- Cable for connecting the personal computer to the LPU unit (RS-232C cross cable with D-sub 9-pin connectors) or cable for connecting the personal computer to the CMU or ET.NET module (10BASE-T or 100BASE-T twisted pair cross cable with RJ-45 modular connectors)

#### **NOTICE**

Users of this product must have an adequate knowledge of the Windows® environment and user interface. This system conforms to the Windows® standard, and this manual is prepared for those users who are familiar with the basic Windows® operating procedures.

# 1 SPECIFICATIONS

## 1.4 Points of Difference from Conventional Modules

Table 1-4 shows points of difference between this module and conventional S10mini-dedicated D.NET modules of models LQE070, LQE170, and LQE175. Of these conventional models, the LQE070 varies in functionality according to the version-revision of the microprogram used with it. To check out the version-revision of the microprogram you use, see Table 1-5. When using any of the models LQE070, LQE170, and LQE175, refer to the S10mini HARDWARE MANUAL, OPTION D.NET (manual number SME-1-106) for the conventional module.

Table 1-4 Points of Difference from Conventional Modules

Item	Module model				
	LQE070			LQE170/175	LQE570/575
Version-revision of microprogram	1.0	2.0	2.1 to 2.9	3.0	4.0 to 4.3   4.4 or later
Usable with the S10V series or not	Unusable			Unusable	Usable
Usable with the S10mini series or not	Usable			Usable	Usable
Bit strobe communication in master mode	Unusable	Usable	Usable	Usable	Usable
Slave mode	Unusable	Usable	Usable	Usable	Usable
Polling communication (Poll) in master mode	Usable (*1)	Usable	Usable	Usable	Usable
Peer refresh time setting in master-peer mode	Refer to the conventional module manual. (The setting range differs.)			Section 4.5	Section 4.5
Master/slave refresh time setting in master-peer mode	Refer to the conventional module manual. (The setting range differs.)			Section 4.5	Section 4.5
PCs OK signal linkage setting	Unusable	Unusable	Unusable	Usable	Usable
Master/slave refresh time setting in slave mode	Unusable	Usable	Usable	Automatic	Automatic
Input/output byte count set by station parameter	0 to 8	0 to 256	0 to 256	0 to 256	0 to 256
Bit reversal mode selection	Unusable	Usable	Usable	Usable	Usable
Byte reversal mode selection	Unusable	Unusable	Unusable	Usable	Usable
Connection timeout monitoring	Unusable	Unusable	Unusable	Usable	Usable
D.Station status information collection	Unusable	Unusable	Usable	Usable	Usable
Remote I/O timeout information collection	Unusable	Unusable	Usable	Usable	Usable
D.Station data format conversion setting	Unusable	Unusable	Unusable	Usable	Usable
Refresh time log information	Unusable	Unusable	Unusable	Usable	Usable
Input/output areas DW000–DWFFF	Unusable	Unusable	Unusable	Usable	Usable
Communication time	Refer to the conventional module manual.			Section 5.4	Section 5.4
CPU load ratio	Refer to the conventional module manual.			Section 5.5	Section 5.5
Response time in slave mode	Refer to the conventional module manual.			Section 5.6	Section 5.6
Error display and action to be taken	Refer to the conventional module manual.			Subsection 7.3.2	Subsection 7.3.2
Slave parameter setting (*2)	Unusable			Unusable	Usable

(\*1) In version 1.0 for the LQE070, the communication type is represented by the term “master/slave.” In this manual, it is represented by “poll.” In either case, the communication type functions the same as “polling communication (Poll) in master mode.”

(\*2) Slave parameter setting is supported only by Ver-Rev 01-03 or later of the S10V D.NET system (model S-7895-31).

Table 1-5 Version-Revisions of the Microprogram

Module model	Version-revision of microprogram	Display on CPU's indicator (* denotes a module number, or MODU No., in the range 0 to 3)
LQE070	1.0	DN* 1.0
	2.0	DN* 2.0
	2.1 to 2.9	DN* 2.X (X: 1 to 9)
LQE170/175	3.0	DN* 3.0
LQE570/575	4.0 or later	DN* X.Y (X: 4 or later, Y: 0 or later)

**This Page Intentionally Left Blank**

## 2 NAMES AND FUNCTIONS OF EACH PART

## 2 NAMES AND FUNCTIONS OF EACH PART

### 2.1 Names and Functions of Each Part

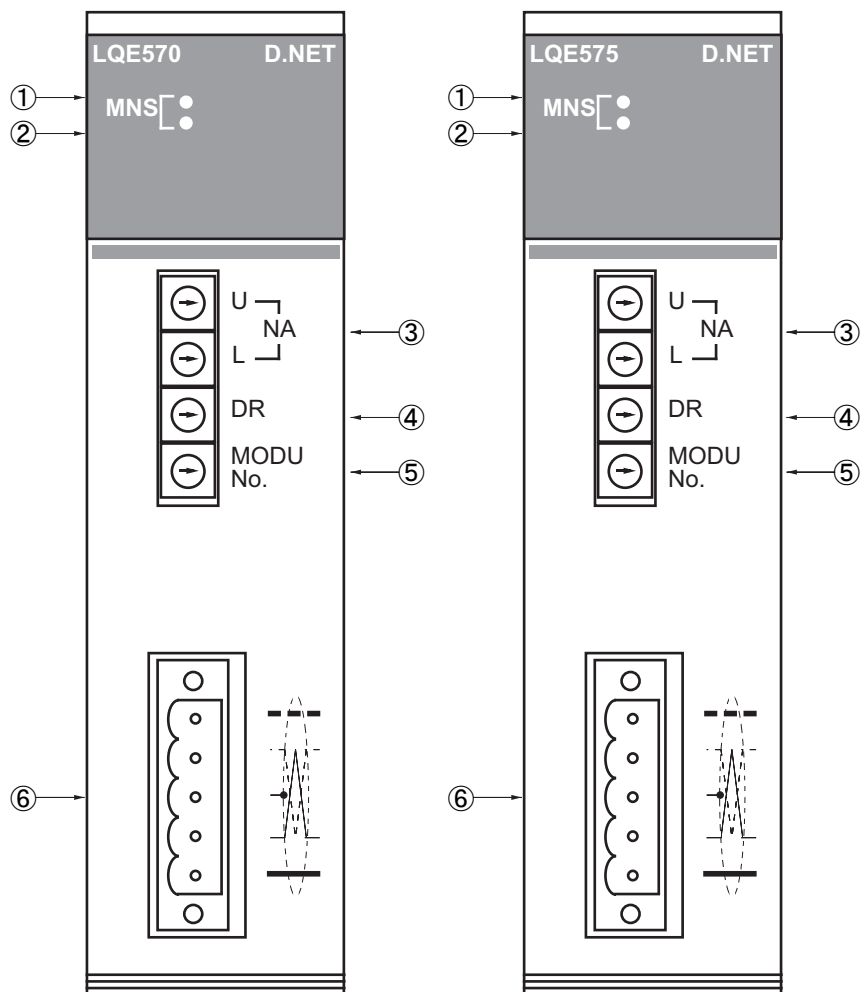

No.	Name	Function
①	Module/Network Status indicator (green)	The On/Off status of these indicators used in combination indicates the operating status of the D.NET module and the network. (For meanings of the combined indicator status, see Table 2-3.)
②	Module/Network Status indicator (red)	
③	Node Address (U/L) setting switch	Used to set an MAC ID (/0 to /3F). The values /40 through /FF are not open for ordinary use. (See the Table 2-1.)
④	Data Rate setting switch	Used to set a baud rate (transmission speed): 0 for 125 kbps, 1 for 250 kbps, 2 for 500 kbps. The values 3 through F are not open for ordinary use.
⑤	Module number (MODU No.) setting switch	Used to set a module number. (See Table 2-2 for available module numbers.)
⑥	DeviceNet interface connector	Connector for DeviceNet interface

Table 2-1 Relationships between NA (Node Address)  
Values (in hexadecimal) and MAC IDs (in decimal)

NA		MAC ID (in decimal)	NA		MAC ID (in decimal)	NA		MAC ID (in decimal)	NA		MAC ID (in decimal)
U	L		U	L		U	L		U	L	
0	0	0	1	0	16	2	0	32	3	0	48
0	1	1	1	1	17	2	1	33	3	1	49
0	2	2	1	2	18	2	2	34	3	2	50
0	3	3	1	3	19	2	3	35	3	3	51
0	4	4	1	4	20	2	4	36	3	4	52
0	5	5	1	5	21	2	5	37	3	5	53
0	6	6	1	6	22	2	6	38	3	6	54
0	7	7	1	7	23	2	7	39	3	7	55
0	8	8	1	8	24	2	8	40	3	8	56
0	9	9	1	9	25	2	9	41	3	9	57
0	A	10	1	A	26	2	A	42	3	A	58
0	B	11	1	B	27	2	B	43	3	B	59
0	C	12	1	C	28	2	C	44	3	C	60
0	D	13	1	D	29	2	D	45	3	D	61
0	E	14	1	E	30	2	E	46	3	E	62
0	F	15	1	F	31	2	F	47	3	F	63

**NOTICE**

- Be sure to operate the NA (Node Address), DR (Data Rate), and MODU No. switches while the D.NET module is powered off. If any of the switches is operated while it is ON, the normal operation of the D.NET module is not guaranteed.
- When mounting only one D.NET module in the CPU or LPU unit, be sure to set the MODU No. to "0".
- When mounting two or more D.NET modules in the CPU or LPU unit, be sure to set MODU No. equal to "0" for one of those modules.



## 2 NAMES AND FUNCTIONS OF EACH PART

---

Table 2-2 shows all allowable set values of the MODU No. setting switch. According to this table, set an appropriate value for the module of each channel. Up to four D.NET modules can be mounted in one single CPU or LPU unit.

Table 2-2 Allowable Set Values of the MODU No. Setting Switch

Set value	Meaning
0	Channel-0 module
1	Channel-1 module
2	Channel-2 module
3	Channel-3 module
4 to 7	Not open for ordinary use
8 to B	Not open for ordinary use (setting in T/M)
C to F	Not open for ordinary use

### **NOTICE**

If you set any of the values 4 thru F shown above, the following warning will result:

- The D.NET module stops communication and the red MNS indicator comes on.
- In the S10mini, the CPU's indicator displays the characters "DN\* MDSW", where "\*" is a channel number of 0 to 3.

The On/Off status of the MNS indicators used in combination indicates the operating status of the D.NET module and network, as shown in the Table 2-3.

Table 2-3 Indications of the MNS LEDs and Their Meanings

MNS (green)	MNS (red)	Meanings	Remarks
○: ON ●: OFF ◎: Flashing			
●	●	The D.NET module is powered off.	–
●	●	<ul style="list-style-type: none"> <li>Object initialization is in progress.</li> <li>A check is in progress to see if the specified MAC ID already exists.</li> </ul>	This condition arises when the D.NET module has started but cannot do communication over the network. For information on how to troubleshoot this problem, see “(1) Factors that disable the D.NET module to do communication,” in “7.2.2 Preliminary checking.”
◎	●	<ul style="list-style-type: none"> <li>Configuration information reception is in progress.</li> <li>Object construction is in progress.</li> <li>A parameter setting error occurred.</li> </ul>	When a “bus off” condition and recovery from it are being repeated indefinitely, the green MNS indicator may seem to be flashing. This indicator status takes place when no remote node is registered yet.
○	●	Communication is in progress (or a non-fatal fault is detected)	In master mode, the remote node (slave) is not connected yet or is in power failure condition. In slave mode, no communication is in progress. (This is the case when the slave is powered on before the master and waiting for data to come from that master.)
●	◎	The bus is Off.	The red MNS indicator flashes at regular intervals of 0.5 seconds, so its flashing due to a “bus off” condition may be unrecognizable when recovery from that condition is made without taking time.
●	○	The specified MAC ID already exists.	There is no difference in LED indication between “MAD ID already exists” and “fatal fault occurred.” These two conditions can be distinguished from each other by referring to the CPU’s indicator or the S-table. S10V users can make such distinction by using the S10V base system.
●	○	A fatal fault occurred.	
●	○	Parameter setting error	
			This type of error will occur if the module is installed in a different machine model than that in which the parameter settings as shown in “4 OPERATION” are made. When this is the case, the MNS (red) comes on.

Supplement:

When the D.NET module is powered on, the green and red MNS indicators turn on as shown below as long as no error occurs.

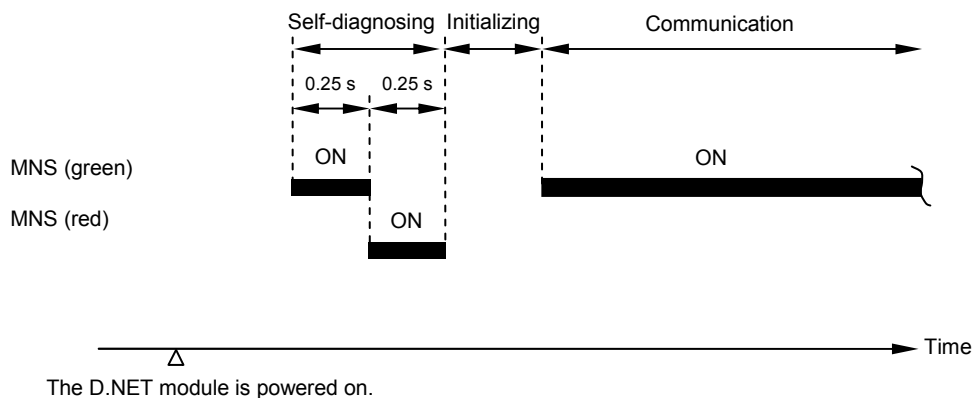

Figure 2-1 MNS LEDs Immediately After Power ON

**This Page Intentionally Left Blank**

# **3 MOUNTING AND WIRING**

### 3.1 Mount Base

The D.NET module can be mounted in any of the mount bases shown in Table 3-1.

Table 3-1 Mount Bases for the D.NET Module

Series	Name	Model	Specifications
S10mini	2-slot mount base	HSC-1020	Power supply + CPU + 2 slots (option, for I/O)
	4-slot mount base	HSC-1040	Power supply + CPU + 4 slots (option, for I/O)
	8-slot mount base	HSC-1080	Power supply + CPU + 8 slots (option, for I/O)
S10V	4-slot mount base	HSC-1540	Power supply + LPU + 4 slots (option, for I/O)
	8-slot mount base	HSC-1580	Power supply + LPU + 8 slots (option, for I/O)

### 3.2 Mounting the Module

Mount the option module in any of the option slots (slot numbers 0 through 7) on the mount base, as shown below.

#### **NOTICE**

S10mini series:

- Mount the option module in the option slot that is located to the immediate right of the CPU module. Be sure that no I/O modules are mounted between this option module and CPU module mounted. Also, ensure that there is no unoccupied slot between mounted option modules.
- This module (LQE570/575) can be mounted together with the LQE070/170/175 D.NET module, which is specially designed for use with the S10mini series.

When installing the LQE070 module containing a built-in microprogram of version-revision 1.0 (hereinafter referred to as LQE070 V1.0) together, set the MODU No. switch of that D.NET module to "0." Without this setting, the LQE070 V1.0 D.NET module cannot function normally.

S10V series:

- There are no specific rules about the mounting position and unoccupied slots.
- The LQE070/170/175 D.NET module cannot be used, as it is specially designed for use with the S10mini series.

Common rules for the S10mini series and S10V series:

- When installing only one D.NET module in place, be sure to set MODU No. to "0".
- When installing multiple D.NET modules in place, be sure to set the MODU No. of one of these modules to "0".

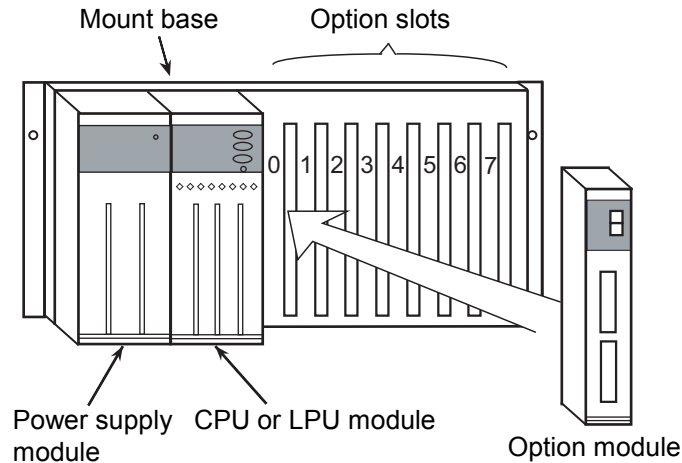
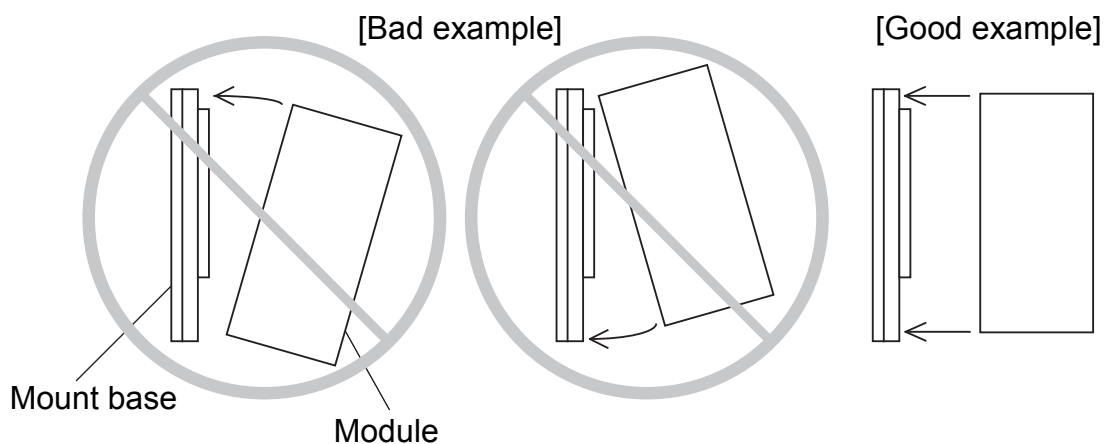

Figure 3-1 Mounting the Option Module

**NOTICE**

- Dust or other foreign matter might accumulate on the connector, resulting in poor connection. Immediately after the module is unpacked, perform the mounting and wiring procedures.
- To prevent the module from being damaged, observe the following precautions when mounting or demounting the module:
  - Before mounting the module onto the mount base connector, check that the connector pins are properly aligned and not bent, broken, or soiled with dirt or the like.
  - When mounting it, ensure that the module's connection surface is parallel to the mount base's vertical surface, as shown below. If you connect the module to or disconnect it from its connector while it is tilted, the connector pins may be damaged.
  - If the mount base is positioned overhead because of the employed enclosure structure, use a stepladder or the like and mount the module squarely, not at an angle. If you mount it obliquely, the connector may be damaged.



### 3.3 Ground Wiring

Carry out ground wiring, as shown in Figure 3-2, by following these steps:

- ① Interconnect the FG terminals of the power supply module, CPU or LPU module, and optional modules and then connect the resulting wiring to the mount base's FG terminal, all by using a 2.0 mm<sup>2</sup> or more wire.
  - The D.NET module (LQE570 or LQE575) is not provided with an FG terminal.
  - For information on whether other optional modules are provided with an FG terminal, refer to the manual that comes with the respective module. (Some modules do not have an FG terminal.)
- ② Wire the mount base's FG terminal to the PC's unit grounding point of the enclosure in which the mount base is housed (by using a 2.0 mm<sup>2</sup> or more wire).
- ③ Perform Class D grounding from the PC's unit grounding point of the enclosure by using a 5.5 mm<sup>2</sup> or more wire.

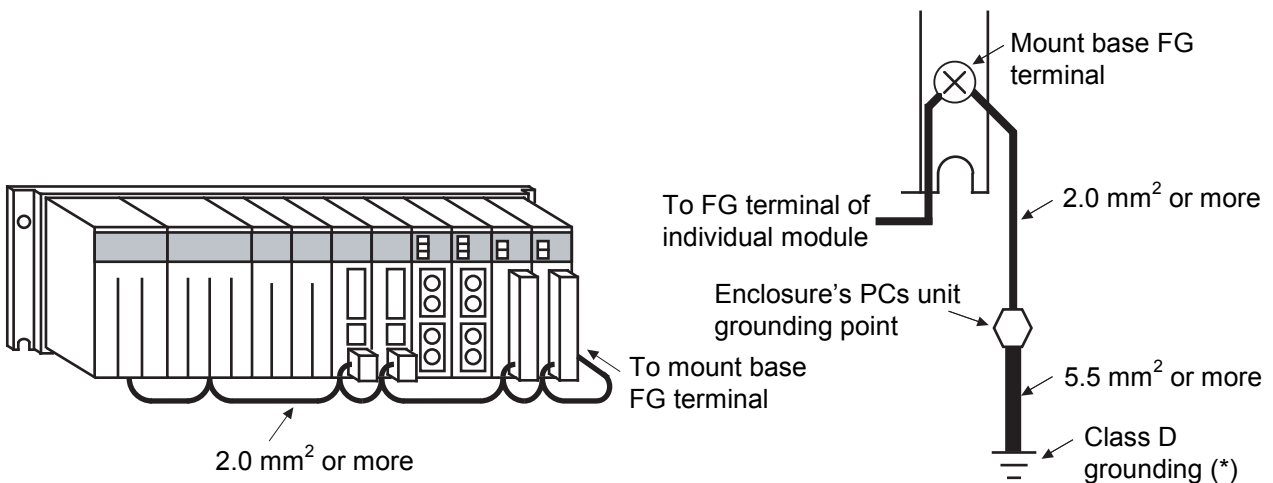

Figure 3-2 Ground Wiring

(\*) Class D grounding is defined in the Technical Standard for Electrical Facilities of Japan. This standard states that the grounding resistance must be 100 ohms or less for equipment operating on 300 VAC or less, and 500 ohms or less for devices that shut down automatically within 0.5 seconds when shorting occurs in low tension lines.

**WARNING**

- Switch off the power supply before making connections to the terminal block. Making connections with the power supply being switched on may incur electrical shock.
- In the event of electric shock, you may suffer burns or get electrocuted to death. Further, the system may malfunction due to noise interference. So, be sure to ground the line ground (LG), frame ground (FG), and shield wire (SHD).

**NOTICE**

- Electrically insulate the mount base from the enclosure. To accomplish this, never remove the insulation sheets supplied with the mount base.
- The LG is a grounding terminal for power supply noise. The FG and SHD are grounding terminals for the noise in the remote I/O communication module and other external interface lines. To prevent interference between the grounding terminals, separately ground the LG and FG.



3.4 Wiring

3.4.1 Interface signals and wiring

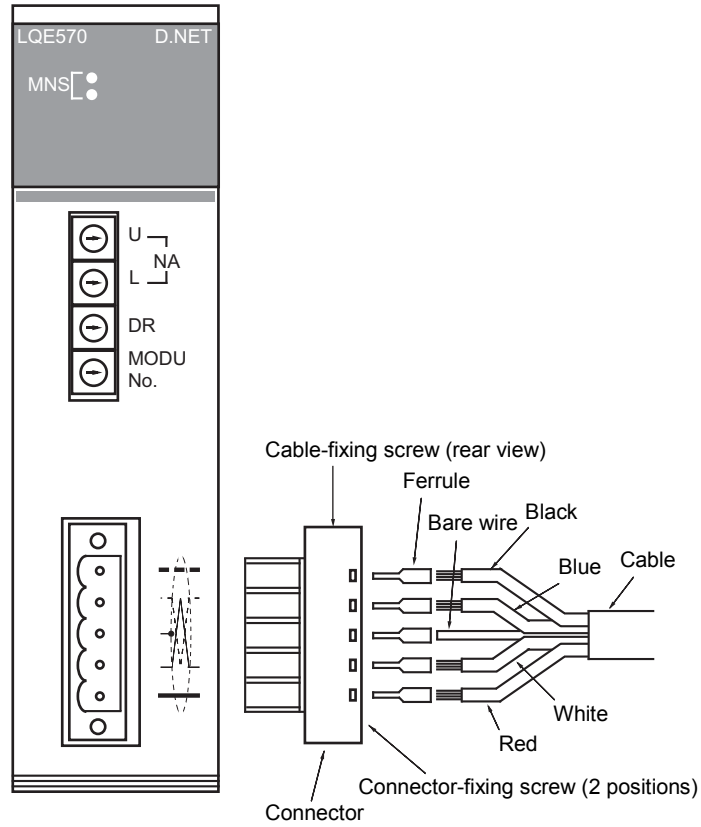

Wire color	Abbreviation	Use
Black	V-	Network power supply (GND)
Blue	CAN-L	Signal wire (L-side)
(Bare wire)	SHD	Shield
White	CAN-H	Signal wire (H-side)
Red	V+	Network power supply (+24 V)

Figure 3-3 Interface Signals and Wiring of LQE570 and LQE575

As shown, first fit the end of each wire of the cable (see “Reference: Specifications of the communication cables” under “3.4.4 Restrictions of cable lengths” for its specifications) into a ferrule and crimp the ferrule to clamp the wire. Then, orient the connector correctly, insert each ferrule into the corresponding hole of the connector, and firmly tighten each terminal screw (with a tightening torque of 0.5 to 0.6 N·m). When the cable is connected completely to the connector, fit the connector to the mating connector on the front panel of the D.NET module, and plug it in firmly.

**NOTICE**

- Be sure to switch off the power to the S10mini or S10V controller, all connected DeviceNet devices, and the communications power supply before connecting the cable to the connector of the LQE570 or LQE575.
- The LQE570 self-feeds communications power and requires no external power supply. Further, its interior is separated from the power wiring, so no problem is caused by connecting a communication power supply to it.
- Check the cable connector periodically (every 3 to 6 months) for any loosened connector-fixing screw, and tightly screw the connector, if necessary.

#### 3.4.2 Hardware configuration

An example of a DeviceNet hardware configuration is shown in Figure 3-4. In any DeviceNet network, a control device connected to the network is called a “node” and the D.NET module is an example of such nodes. Nodes can be classified into two types: a slave, which inputs information from and outputs it to the outside, and a master, which collectively controls and manages slaves in the network.

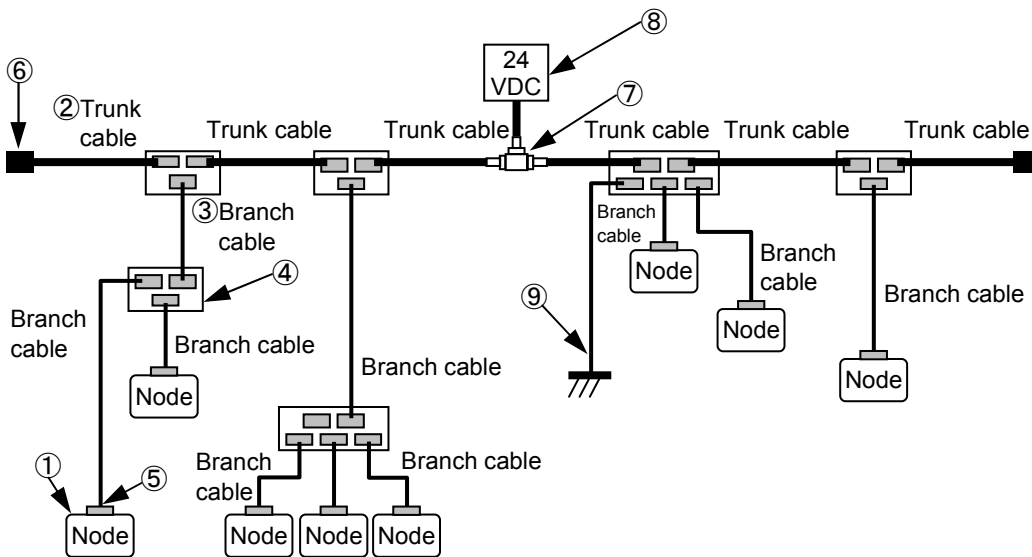

Figure 3-4 DeviceNet Hardware Configuration Example

The following are the components of DeviceNet networks:

- ① Nodes  
Nodes can be classified into two types: a slave, which inputs information from and outputs it to the outside, and a master, which collectively controls and manages slaves in the network. In a DeviceNet network, the master and slaves can be placed anywhere, regardless of their roles.
- ②③ Trunk cable and branch cable  
Communication cables connected to DeviceNet networks are classified into two types: trunk cable and branch cable. A trunk cable is a bundle of cables each having terminating resistors at both ends. A cable branching from the trunk cable and a cable branching from a branch cable are collectively called branch cables. A node is connected to a branch cable. Dedicated 5-wire cables (thick or thin type) are used as communication cables.
- ④ T-branch tap  
DeviceNet networks use T-branch taps to branch a cable from the trunk cable and to branch a cable from a branch cable. It is also possible to use a terminal block to connect and branch cables.
- ⑤ Connector  
There are two types of connectors that connect communication cables to a node and to a T-branch tap: open and closed. The open-type connector is preferably used to connect a communication cable to a D.NET module and to a T-branch tap.

## ⑥ Terminating resistor

In any DeviceNet network, each end of the trunk cable must be terminated with a terminating resistor ( $121\ \Omega \pm 1\%$ ). There are many ways of termination, but it is recommended to use terminal blocks (TBs) and terminating resistors for TBs.

## ⑦⑧ Power taps and communication power supply

Communication over DeviceNet networks requires that a 24-VDC communication power supply be connected to the network through a power tap, and that power be supplied to each node of the network through communication cable. Communication power supplies can also be connected to the network through T-branch taps and TBs.

## ⑨ Network grounding

The shield of the communication cable must be grounded at only one point near the center of the network so that no grounding loops may be formed. For this, more than one method is available, for example, by grounding at a D.NET module, by grounding from a tap, and by grounding from a TB. In the above configuration example, the shield is grounded from a T-branch tap.

Other recommended components of the DeviceNet control mechanism (than the nodes) are listed below.

If a terminal block (TB) is used, screws for the terminal block and solderless terminals for the communication cables are also required in addition to the components listed below.

Table 3-2 Recommended Component Parts

No.	Part name	Specifications	Recommended product	
			Model	Manufacturer
②	Thick cable	5-wire communication cable	UL20276-PSX1P×18AWG+1P×14AWG (*)	Hitachi Cable, Ltd.
③	Thin cable	5-wire communication cable	UL20276-PSX1P×24AWG+1P×24AWG (*)	Hitachi Cable, Ltd.
④	T-branch tap	Open-type T-branch tap	DNC1-1C	OMRON Corporation
		Open-type 3-branch tap	DNC1-3C	
⑤	Connector	Open type	MSTB2.5/5-ST-5.08-AU: Applicable models: LQE070/170/175/570/575 MSTB2.5/5-STF-5.08-AU: Applicable models: LQE170/175/570/575	Phoenix Contact GmbH & Co.
	Ferrule	Used to connect a thick cable (signal) to a connector.	A1-6	
		Used to connect a thick cable (power) to a connector.	A2.5-7	
		Used to connect a thin cable to a connector.	VPC-0.5-F8	JST Mfg. Co., Ltd.
⑥	Terminating resistor	Provided for a terminal block.	MFB120ΩCT1	Tama Electric Co., Ltd.
⑦	Power tap	Equipped with a reverse current stopper and a grounding terminal.	1485T-P2T5-T5	Rockwell Automation Japan Co., Ltd.
⑧	Communication power supply	24 VDC	S82J-5524	OMRON Corporation

(\*) The cable length is specified separately.

### 3 MOUNTING AND WIRING

#### 3.4.3 Components

##### (1) Communication cables

There are two types of dedicated 5-wire communication cable conforming to the DeviceNet standard: thick and thin. Their physical structures are identical as shown in Figure 3-5.

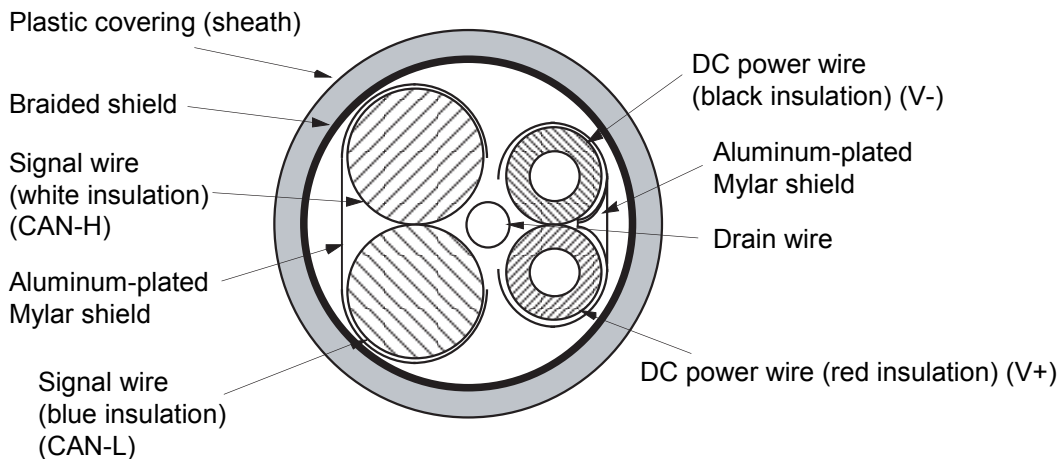

Cable type	Outer diameter (mm)
Thick cable	11.2 to 12.1
Thin cable	6.9

Figure 3-5 Communication Cable

The thick cable is resistant to bending and is less in signal attenuation than the thin cable. So, the thick cable is fit for applications using communications over a comparatively long distance. Usually, thick cables are used as long trunk cables. In contrast, the thin cable is flexible and easy to bend but it has significant signal attenuation. So, thin cables are not fit for long-distance communications. Usually, they are used as branch cables. In a small network, thin cables can be used as short trunk cables. As shown in Figure 3-6, you must provide a straight length of about 5 cm or more on the connection end of the communication cable connected to the D.NET module. Do not bend the cable too sharp. The bending radius (R) of the cable must be at least 25 cm (for a thick cable) or 15 cm (for a thin cable).

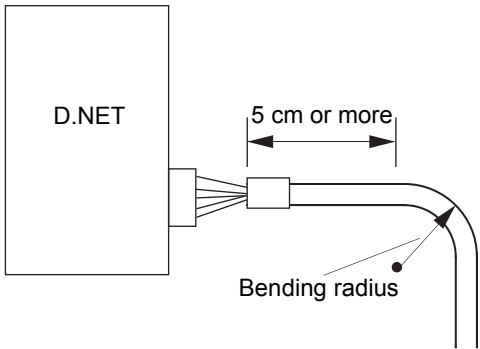

Figure 3-6 Bending Radius of the Cable

**NOTICE**

- Cables of the same type (e.g., communication cables) must not be intermingled with cables of other types (e.g., power cables and motor lead cables). Particularly, communication lines must be isolated at least 300 mm from lead cables from inverters, motors, power regulators, etc. Do not put communication cables and power cables together in the same pipe or conduit.
- Always use dedicated 5-wire communication cables conforming to the DeviceNet standard. Do not use any other cables for communication.
- Do not extend cables tautly between connecting points. Provide enough slack in connected cables for future re-wiring due to repairing or device movement.
- Do not clamp or tie cables tightly together. Clamp or tie the cables loosely so that you can easily move them later for adjustment. Applying an excessive force to cables may damage them.
- Do not yank the communication cable or pull it strongly. Exerting an excessive force on such a cable may cause disconnection or breakage of wire.
- Do not put a heavy object on the communication cable. Disregarding this rule may cause disconnection or breakage of wire.

### 3 MOUNTING AND WIRING

#### (2) Connectors

Removable connectors are used to connect communication cables to nodes and to branch taps. The DeviceNet system allows the use of two types of connector: open and closed. However, the open-type connectors, particularly plug-in screw connectors, are recommended to connect cables to D.NET modules and T-branch taps.

The plug-in screw connector enables removal of a node without segmenting the network.

An external view and the pin assignment of an open-type connector are shown in Figure 3-7.

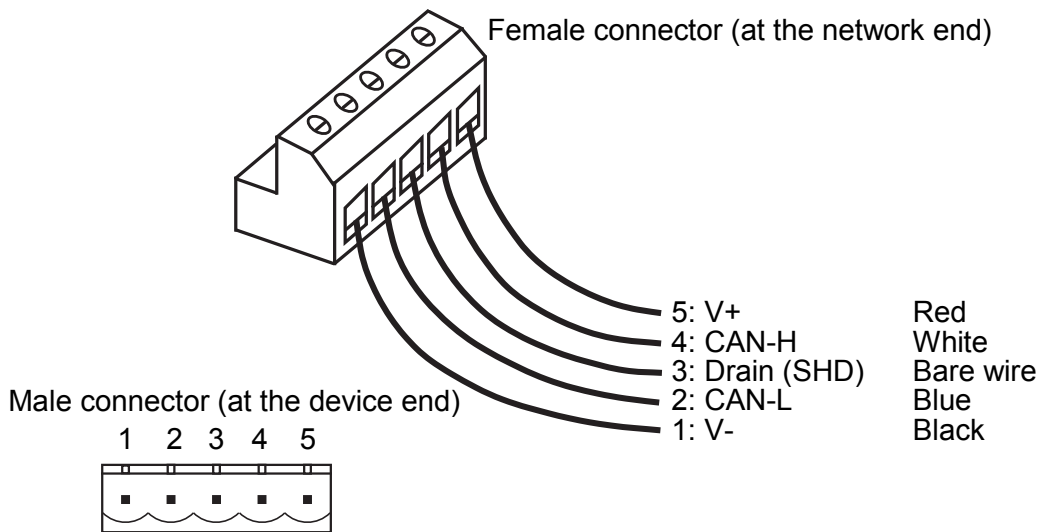

Figure 3-7 Connector

#### **NOTICE**

- Always use ferrules to connect wires of the communication cable to the plug-in screw connector. If such a cable is connected to the plug-in screw connector without using ferrules, it may be easily disconnected or broken.
- Do not extend cables tautly between connecting points. Provide enough slack in connected cables so as not to give an excessive force to the connectors.
- Connection of a node other than the D.NET does not always require an open type connector. For other companies' nodes, connect them with communication cables according to the manual for each node.
- Connect the signal wires, power wires, and the drain wire correctly to the connector. Note that the power wires of the thick cable require different ferrules than the other wires of the same cable.

## (3) T-branch taps

T-branch taps are used to branch the trunk cable and branch cables. Two types of T-branch taps are available for use in the DeviceNet network: open and closed. The open-type tap is preferably used. T-branch taps are further classified into two types: 1-branch and 3-branch. The connecting methods of these two types are identical. The structures and connections of the 1-branch type and 3-branch type T-branch taps are shown in Figure 3-8.

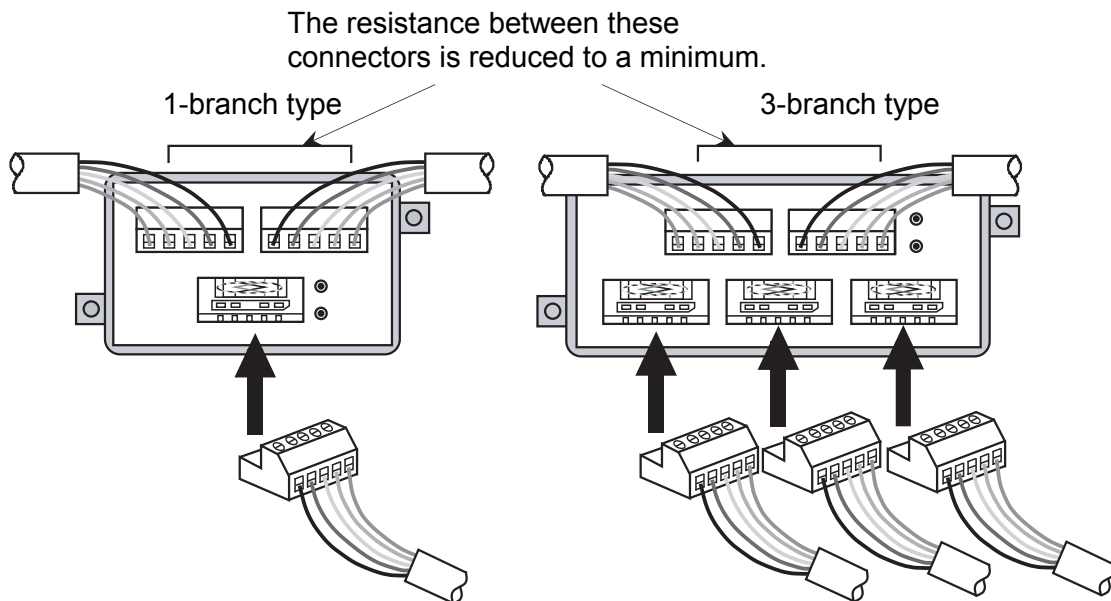

Figure 3-8 T-branch Taps

A T-branch tap has different resistances between its connectors. The resistance between the upper two connectors of the T-branch tap (see Figure 3-8) is smallest, so it is recommended to connect the longest branches to these connectors.

**NOTICE**

Each T-branch tap has holes for fixing it. After connecting the communication cables to the tap, secure the tap firmly with screws.



### 3 MOUNTING AND WIRING

Communication cables can also be branched by using terminal blocks (TBs). Attach an appropriate solderless terminal to the end of each cable wire and connect the wire to the terminal block. Figure 3-9 shows an example of a TB connection.

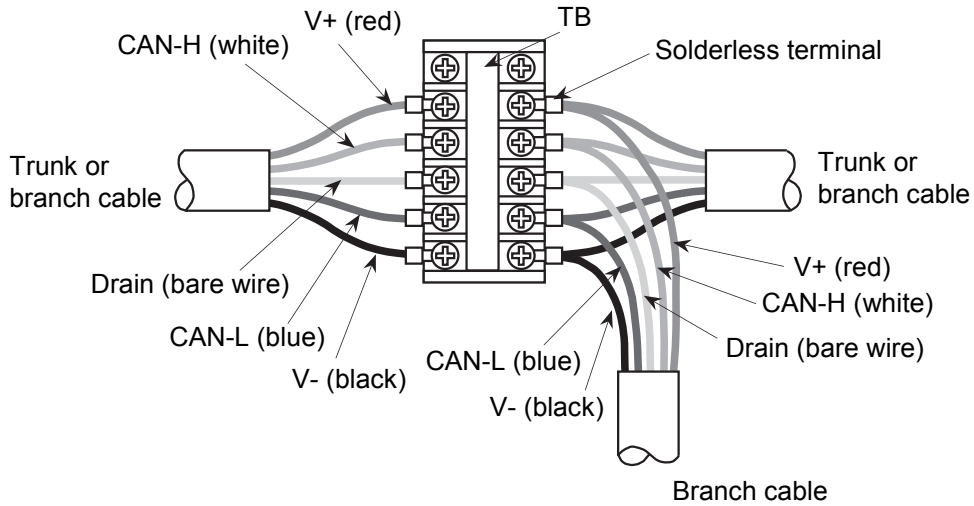
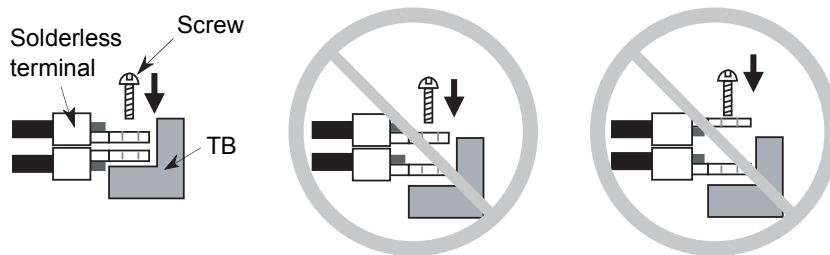

Figure 3-9 Terminal Block

#### **NOTICE**

When branching a cable via a TB, two wires need to be connected to a single terminal of that TB. In these cases, you must assure complete contact of the solderless terminals with the terminal of the TB. To accomplish this, face the two solderless terminals of the wires back to back on the block terminal and tighten the screw. If the solderless terminals are not faced back to back, an incomplete terminal contact may occur, resulting in a communication error.



## (4) Terminating resistors

Each end of the trunk cable of the DeviceNet network must always be terminated with a terminating resistor conforming to the following specifications:

Specifications:

Resistance: 121  $\Omega$

Tolerance:  $\pm 1\%$

Permissible loss: 1/4 W

Type: Metal film

There is more than one way to connect terminating resistors to the trunk cable but it is recommended to use a terminal block. Solder an appropriate solderless terminal to each lead of the terminating resistor, then cover the entire resistor with a piece of Teflon tube, and finally connect the solderless terminals to the terminal block. The terminating resistor may be connected in any orientation but it must always be connected between the signal wires (CAN-H and CAN-L).

Figure 3-10 shows an example of a terminating-resistor connection.

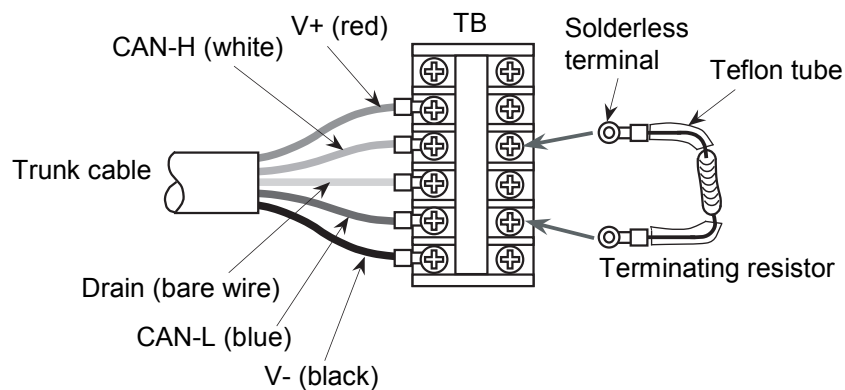

Figure 3-10 Terminating Resistor

### **NOTICE**

When connecting a terminating resistor to a terminal block (TB), always connect it between the signal wires (CAN-H and CAN-L). If it is connected to other terminals, normal communication will not be possible.

### 3 MOUNTING AND WIRING

(5) Power supply tap and communication power supply

The DeviceNet communication cable contains power lines to directly supply power from the network to the nodes. No additional power supply is required for each individual node. Therefore, a communication power supply rated at 24 V must be connected to the trunk cable.

There are two common ways of connecting power wires to the trunk cable: by dedicated power tap and by terminal block (TB). T-branch taps can also be used if the current consumption is 3 A or less.

Basically, DeviceNet uses one single power supply per network. However, if two or more power supplies are required (as a result of consideration as described in “3.4.5 Consideration on the location of a communication power supply”), their power lines must be separated from each other. This can be accomplished by disconnecting the power wire V+ by using a power tap or a terminal block (TB).

These separation methods are shown in Figures 3-11 to 3-13.

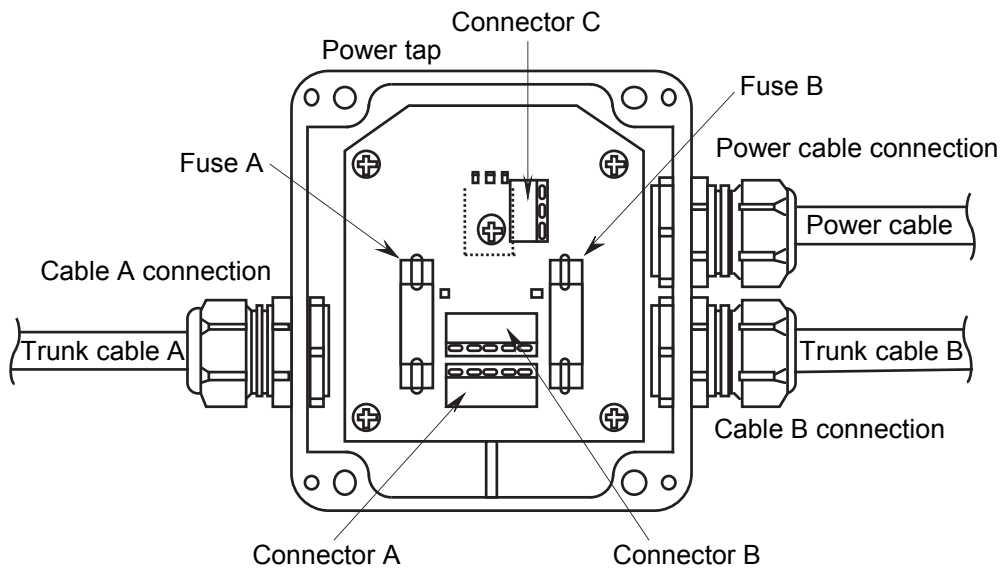

Figure 3-11 Connecting a Power Cable by Power Tap

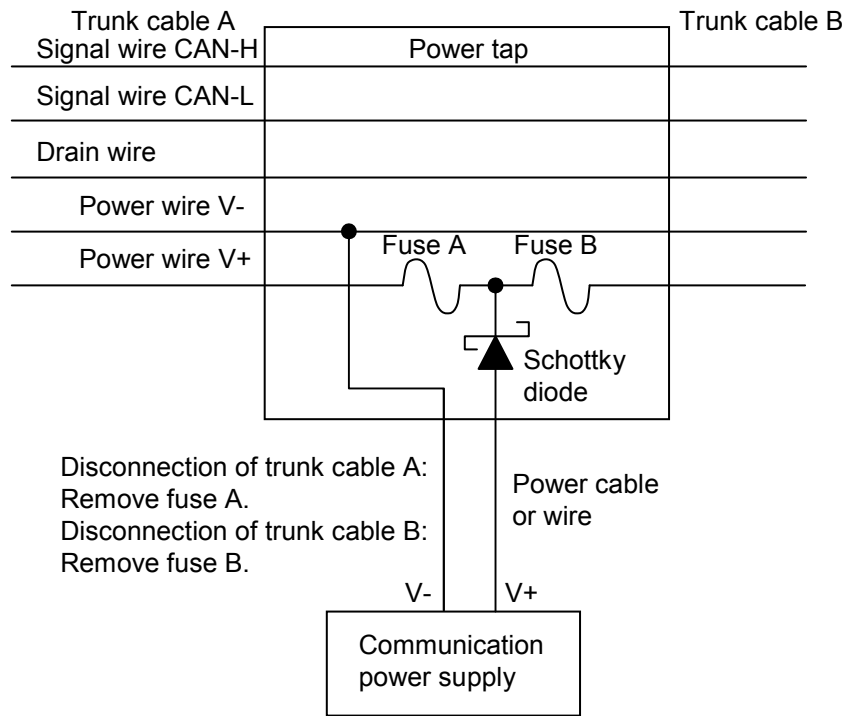

Figure 3-12 Disconnecting a Power Wire by Power Tap

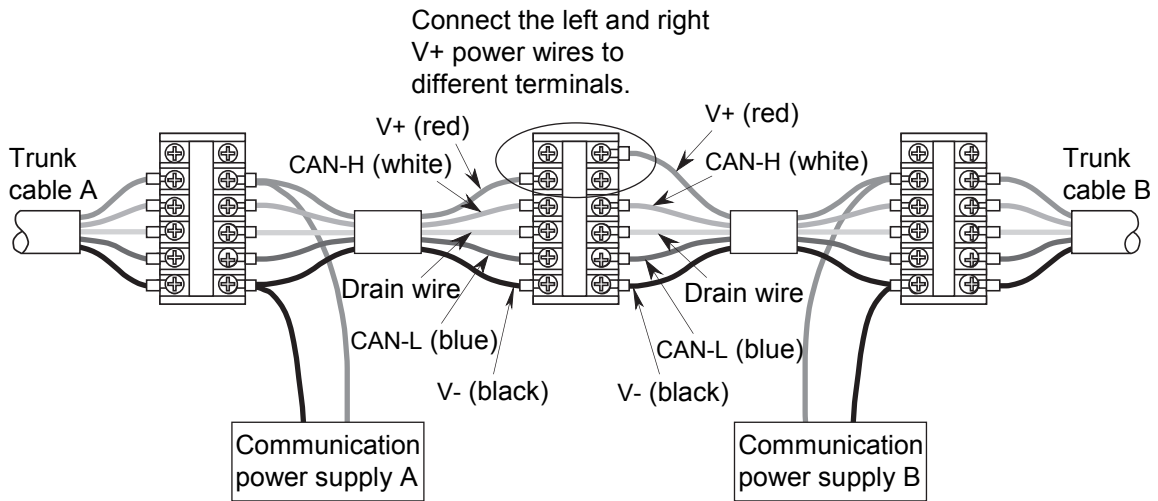

Figure 3-13 Connecting and Disconnecting Power Wires by Terminal Block

### 3 MOUNTING AND WIRING

Below are listed the specifications of the communication power supply conforming to the DeviceNet standard.

Table 3-3 Communication Power Supply Specifications

Item	Specifications
Power initial setting	24 VDC $\pm$ 1% (23.76 to 24.24 V)
Maximum rating	Output current of 16 A or less
Voltage fluctuation	0.3% maximum
Load fluctuation	0.3% maximum
Influence by ambient temperature	0.03%/°C maximum
Input voltage range	120 V $\pm$ 10%
	230 V $\pm$ 10% (if necessary) or automatically selected in the range of 95 V to 250 V
Input frequency range	48 to 62 Hz
Output ripple	250 mVp-p
Electrostatic capacitance of load	7000 $\mu$ F maximum
Ambient temperature	Operating: 0 to 60°C
	Non-operating: -40 to 85°C
Restriction of a rush current from power supply	Restricted to less than 65 A
Protection against overvoltage	Provided (no specified value)
Protection against overcurrent	Provided (maximum current: 125%)
Time required for power-up	250 ms to reach 5% of the final output voltage
Overshoot at startup	0.2% maximum
Insulation	Provided between output and AC power supply and between output and frame ground
Standards	Required: UL
	Recommended: FCC Class B, CSA, TUV, VDE
Ambient relative humidity	5 to 95% (non-condensing)
Surge current withstand	Reserve capacity of 10%

#### **NOTICE**

- Always use a communication power supply having overvoltage and overcurrent protecting functions.
- Make sure all the cables are connected correctly before switching on the power supply.
- Add a line filter to the primary side of the communication power supply.

(6) Network grounding

The network, if not grounded properly, may be affected by discharge of static electricity and external power noise, resulting in malfunction or, in the worst case, failure. To prevent this, DeviceNet is grounded at a single point. If DeviceNet is grounded at more than one point, a grounding loop may be formed. In addition, the network must be grounded only at a point near the center of the network. The grounding must be Class D grounding.

Connect the drain wire from the shield of the trunk cable to a T-branch tap or a terminal block (TB) and lead a single wire, stranded wire, or braided copper wire from that point to a complete grounding rod or grounding part of the building. Figures 3-14 and 3-15 show how the drain wire is connected for grounding from a T-branch tap or terminal block.

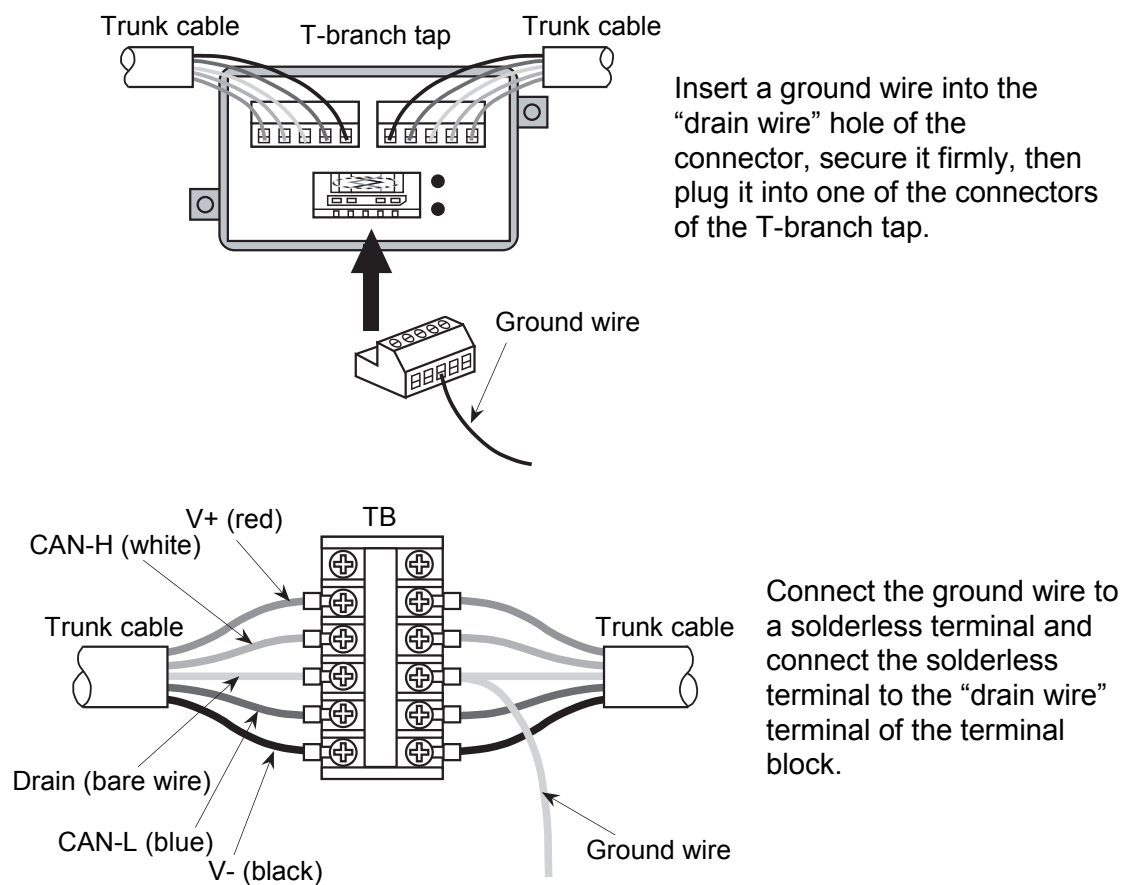

Figure 3-14 Ground Wire Leading-out Method (1)

### 3 MOUNTING AND WIRING

In addition to the above, it is also possible to ground from the D.NET module connected near the center of the network. In this case, as the drain terminal of the D.NET module is not grounded, the grounding is done as shown in Figure 3-15: (1) peel the braided shield of the communication cable, (2) solder a ground wire to the braided shield, (3) attach an M3 solderless terminal to the free end of the ground wire, and (4) connect the solderless terminal to the cable shield connection terminal on the mount base of the D.NET module.

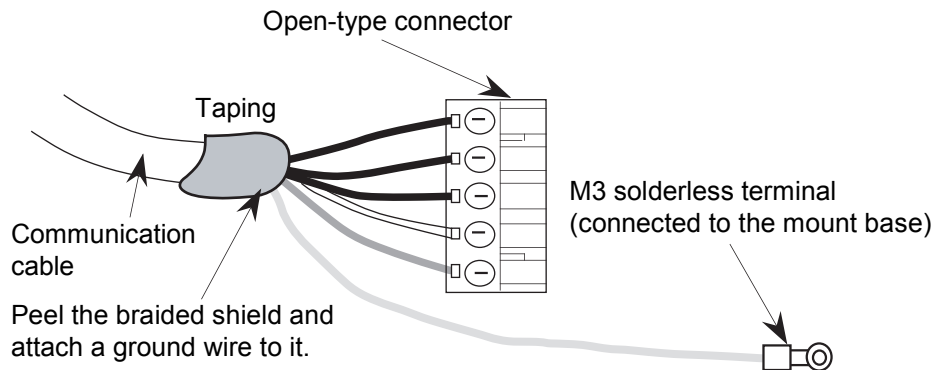
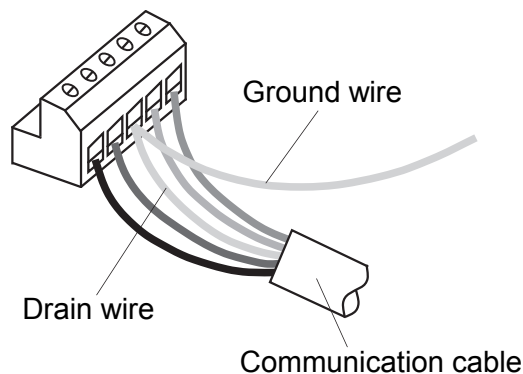

Figure 3-15 Ground Wire Leading-out Method (2)

#### **NOTICE**

- Do not connect the ground wire to the drain terminal of the open-type connector that has a drain wire already connected as shown below.



- Do not ground the communication cable and lead cables of inverters, motors, etc. to the same grounding point. If such grounding is done, power noise will be induced into the communication cable through the ground wire.

3.4.4 Restriction of cable lengths

The lengths of cables in DeviceNet are restricted. Observe the following rules when building up a DeviceNet network.

(1) Maximum network length

The maximum network length is the distance between two nodes located furthest from each other or the distance between two installed terminating resistors, whichever is longer. It varies with the type of the trunk cable and the transfer rate used in the network. This is shown in Figure 3-16.

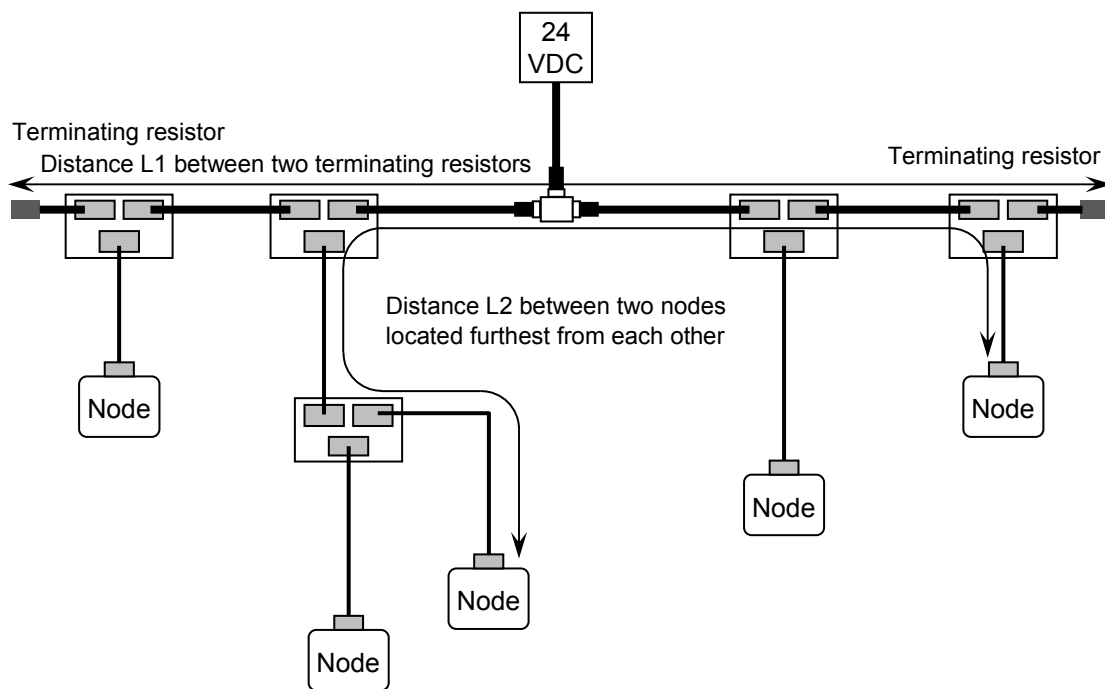

Maximum network length: L1 if L1 > L2 or L2 if L1 < L2

Figure 3-16 Maximum Network Length

Table 3-4 Cable Types and Network Transfer Rates

Transfer rate	Trunk cable types		
	Thick cable only	Thin cable only	Thick and thin cables
500 kbps	100 m or shorter	100 m or shorter	$L_{THICK} + L_{THIN} \leq 100 \text{ m}$
250 kbps	250 m or shorter		$L_{THICK} + 2.5 \times L_{THIN} \leq 250 \text{ m}$
125 kbps	500 m or shorter		$L_{THICK} + 5 \times L_{THIN} \leq 500 \text{ m}$

The symbol “LTHICK” represents a thick cable length and “LTHIN” represents a thin cable length.



### 3 MOUNTING AND WIRING

#### (2) Branch cable length

The branch cable length is the distance between a point at which a communication cable branches from the trunk cable and a point (node) at which the branch ends. The maximum branch cable length is 6 meters, regardless of the transfer rate used. The maximum length of a power line from the trunk cable is 3 meters.

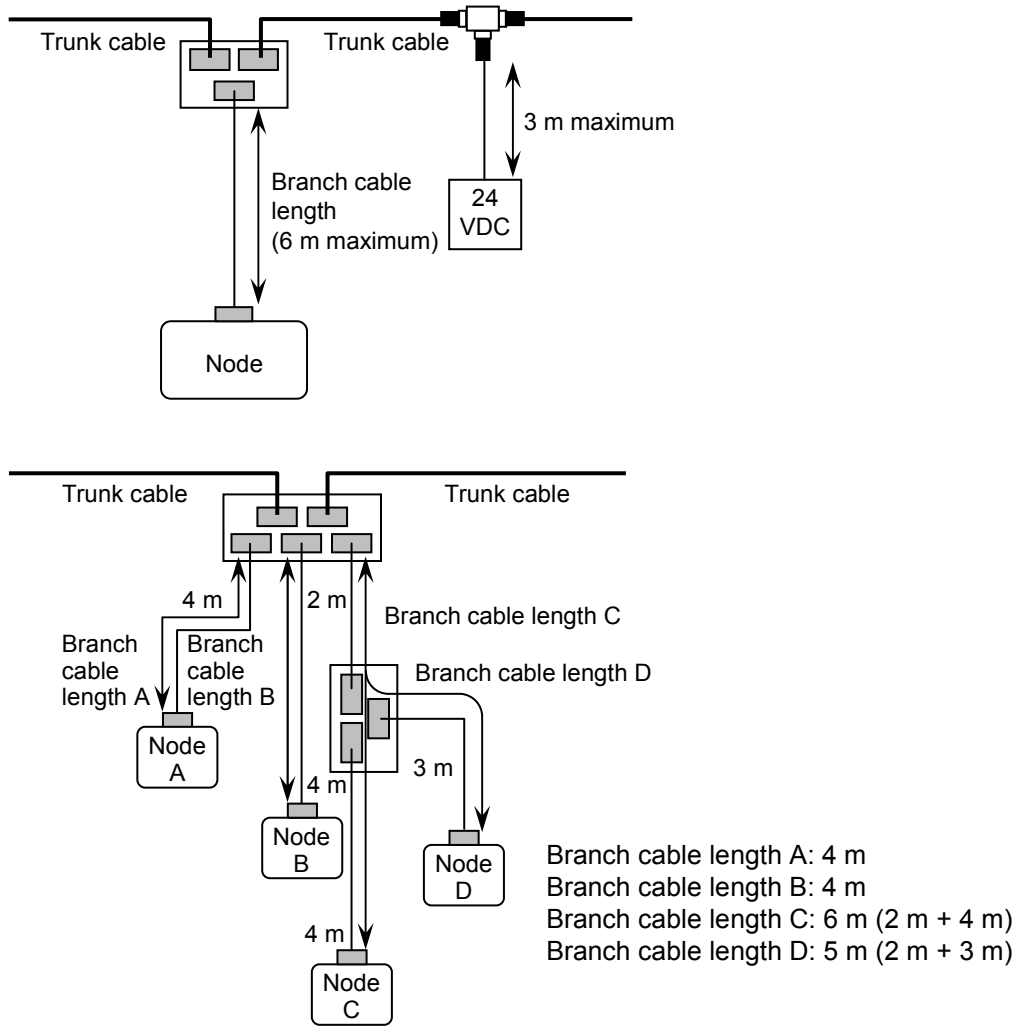

Figure 3-17 Branch Cable Lengths

(3) Total branch cable length

The total branch cable length is the simple total of the lengths of all branch cables in the network, not the total of the cable lengths between all nodes and the corresponding branch taps of the trunk cable. The allowable total branch length varies with the transfer rate used in the network. For example, in the network shown below, the total branch cable length is 40 meters and the transfer rate that can be used is either 125 kbps or 250 kbps.

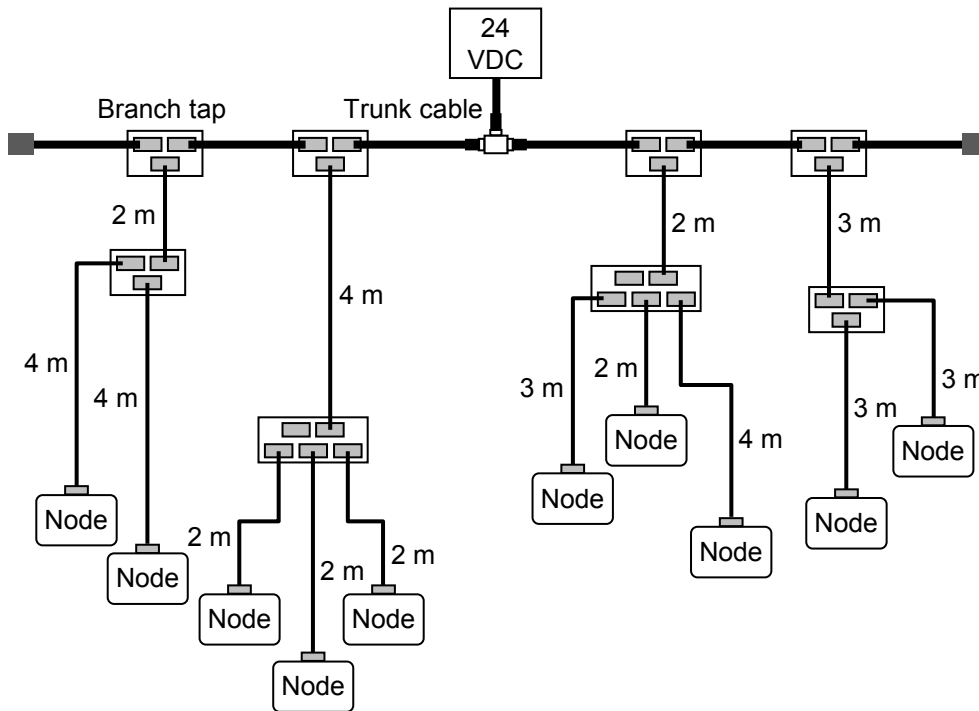

Figure 3-18 Total Branch Cable Length

Table 3-5 Transfer Rates and Total Branch Cable Lengths

Transfer rate	Total branch cable length
500 kbps	39 m or shorter
250 kbps	78 m or shorter
125 kbps	156 m or shorter

### 3 MOUNTING AND WIRING

Reference: Specifications of the communication cables

Table 3-6 Specifications of the Communication Cables

Item		Trunk cable (Thick cable)	Branch cable (Thin cable)
Signal wire	Cross section of conductor	AWG18	AWG14
	Outer diameter of insulator	3.81 mm	1.96 mm
	Color	Blue and white	Blue and white
	Impedance	120 $\Omega \pm 10\%$	120 $\Omega \pm 10\%$
	Propagation delay	4.46 ns/m	4.46 ns/m
	Attenuation factor	500 kHz: 0.820 dB/100 m 125 kHz: 0.426 dB/100 m	500 kHz: 1.640 dB/100 m 125 kHz: 0.951 dB/100 m
	Conductor resistance	22.6 $\Omega$ /1000 m	91.9 $\Omega$ /1000 m
Power wire	Cross section of conductor	AWG15	AWG22
	Outer diameter of insulator	2.49 mm	1.40 mm
	Color	Red and black	Red and black
	Conductor resistance	8.9 $\Omega$ /1000 m	57.4 $\Omega$ /1000 m
	Maximum current	8 A	3 A
Outer diameter of cable product		10.41 to 12.45 mm	6.10 to 7.11 mm

Table 3-7 Recommended Cable Models

Trunk cable (Thick cable)	Branch cable (Thin cable)	Length	Color	Manufacturer
UL20276-PSX 1P $\times$ 18AWG + 1P $\times$ 14AWG	UL20276-PSX 1P $\times$ 24AWG + 1P $\times$ 22AWG	100 m	Gray	Hitachi Cable, Ltd.
		300 m		
		500 m		
TDN18-100G	TDN24-100G	100 m	Light gray	SWCC Showa Holdings Co., Ltd.
TDN18-300G	TDN24-300G	300 m		
TDN18-500G	TDN24-500G	500 m		
TDN18-100B	TDN24-100B	100 m	Light blue	
TDN18-300B	TDN24-300B	300 m		
TDN18-500B	TDN24-500B	500 m		

### 3.4.5 Consideration on the location of a communication power supply

In the DeviceNet network, each node is supplied power through a 5-wire communication cable via a communication connector. Therefore, in addition to consideration on the cable length restriction (see “3.4.4 Restriction of cable lengths”), it is also necessary to consider whether each node can be supplied power from a planned power supply location.

Before starting your consideration, obtain the following information in advance:

- Current consumption (current requirement) at each node
- Type (thick or thin) and length of each communication cable determined through consideration as described under “3.4.4 Restriction of cable lengths”

First of all, make sure that the total current requirement of all nodes is within the current capacity of the communication power supply. If the total current consumption of the nodes is greater than the current capacity of the communication power supply, replace the power supply with a power supply of a larger current capacity or divide the power supply system into two or more subsystems and provide a power supply for each of the subsystems.

Next, check out the maximum current capacity of each cable. The maximum current capacity of the trunk cable is 8 A (for thick cable) or 3 A (for thin cable). Therefore, as shown below, you can feed a current of up to 16 A (through a thick trunk) or 6 A (through a thin trunk) from a single power supply.

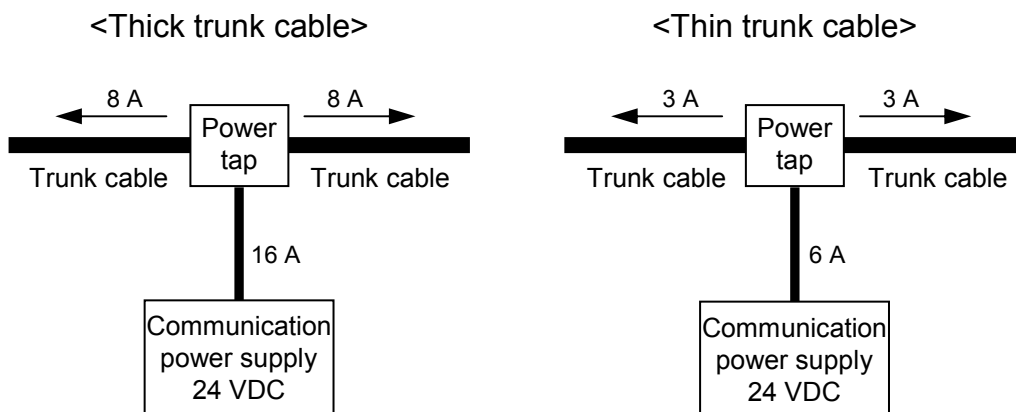

Figure 3-19 Allowable Power Supply Capacity

### 3 MOUNTING AND WIRING

---

However, if the total current requirement of the nodes connected to a thin-cable trunk is greater than 6 A, the thin cable cannot meet the requirement (even when the location of the power supply is changed). So, consider replacement of the thin cable with a thick cable.

Further, the maximum current capacity of a branch cable varies with its length --- the longer the cable, the smaller the maximum current capacity, which is true to both thick and thin cables.

The maximum current capacity (I) of a branch (i.e., the total current consumption through the branch) is expressed by:

$I = 4.57/L$  (however, the result must be less than 8 A for thick cable or less than 3 A for thin cable)

where:

I: Current capacity of a branch cable (A)

L: Branch cable length (m)

If the maximum current capacity of a branch cable is less than the total current consumption of the nodes connected to the branch cable, take the following measures:

- Shorten the branch cable.
- If the branch cable is shared by two or more nodes, remove one or more of the nodes from the cable and attach the removed node(s) to a new branch cable.

After you have made sure that the total current consumption of the nodes is less than the maximum current capacity of the branch cable, determine where to locate the power supply in consideration of a voltage drop in the trunk cable. There are two ways to determine the location in which to place the power supply.

- Method 1: Using a graph and simple calculation
- Method 2: Calculating a voltage drop from the resistance of the communication cable and the current consumption by using equations

If Method 1 produces a result meeting the given condition (i.e., the total current requirement must be less than the maximum current capacity), the power supply can be placed at your planned location. This method gives you the worst possible result in terms of power supply. Therefore, even when the result does not meet your plan, Method 2 may produce a result meeting the given condition. In this case, the power supply can be placed at your planned location.

(1) Method 1: Using a graph and simple calculation

This method is a fast and easy method for determining where to place the power supply.

Note that the graph to be used varies according to the type of the trunk cable used (thick or thin).

First, find the maximum current capacity of the cable on the graph of “trunk cable length vs. maximum current” matching the type and total length of the trunk cable. Then, if the total current consumption of all the nodes does not exceed the maximum current capacity found on the graph, the power supply can be placed at your planned location.

However, if it exceeds the maximum current capacity found on the graph, take the measures listed below. If none of these measures can reduce the total current consumption below the maximum current capacity, calculate voltage drops by using Method 2, which takes the actual node arrangement into consideration.

- If the cable used is a thin cable, replace it with a thick cable and find the maximum current capacity of that thick cable at its length.
- Move the power supply toward the center of the trunk cable so that the nodes will be divided into two groups, one on the left side of the power supply and one on its right side. Then, find the maximum current capacity of the left trunk cable (i.e., the left side of the power supply) and that of the right trunk cable, and compare the total current consumption of the left-side nodes with that of the right-side nodes.
- If the total current consumption of the nodes on one side is found greater than the maximum current capacity of the truck cable on the same side, move the power supply toward the farthest end of that side. Repeat this as many times as required.

**NOTICE**

The LQE570 has communication power supplied by self-feeding, so no such power is included in the current consumption calculation. Further, this model allows the connection of a network power cable to it. This causes no problem because the power cable is not connected internally in the D.NET module.

### 3 MOUNTING AND WIRING

<Thick-cable trunk lengths and maximum currents>

Table 3-8 Thick-Cable Trunk Lengths and Maximum Currents

Trunk cable length (m)	0	25	50	100	150	200	250	300	350	400	450	500
Maximum current (A)	8.00	8.00	5.42	2.93	2.01	1.53	1.23	1.03	0.89	0.78	0.69	0.63

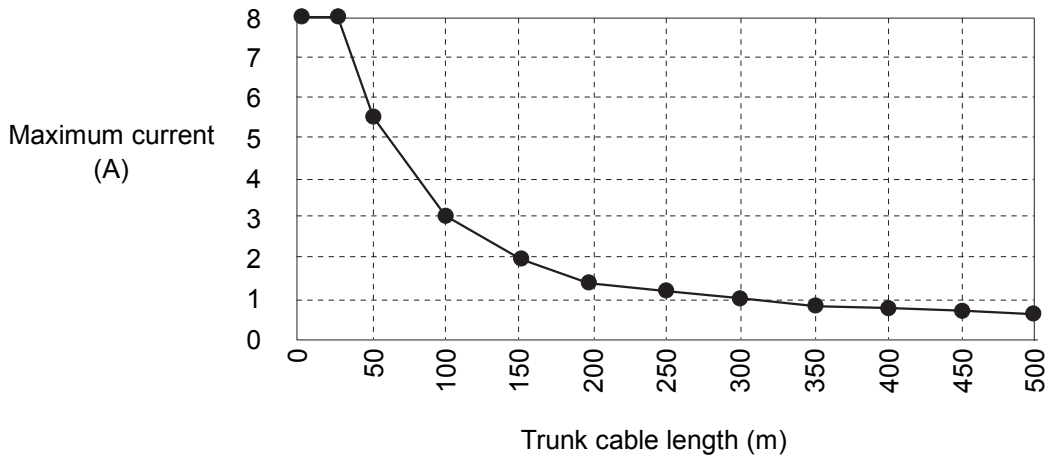

Figure 3-20 “Trunk Cable Length vs. Maximum Current” for Thick Cables

<Thin-cable trunk lengths and maximum currents>

Table 3-9 Thin-Cable Trunk Lengths and Maximum Currents

Trunk cable length (m)	0	10	20	30	40	50	60	70	80	90	100
Maximum current (A)	3.00	3.00	3.00	2.06	1.57	1.26	1.06	0.91	0.80	0.71	0.64

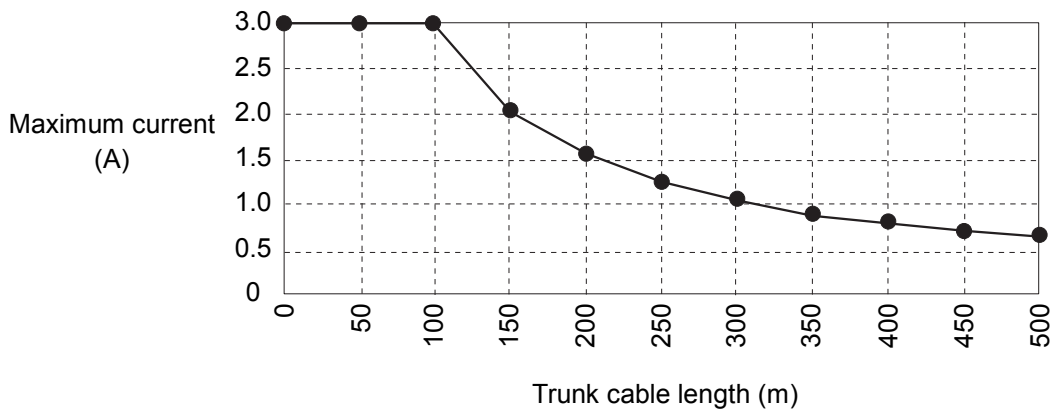

Figure 3-21 “Trunk Cable Length vs. Maximum Current” for Thin Cables

## &lt;Example of using Method 1&gt;

The example below assumes that a single power supply is connected to one end of a trunk cable of 300 m long and that the nodes on the trunk cable have the current consumptions shown below.

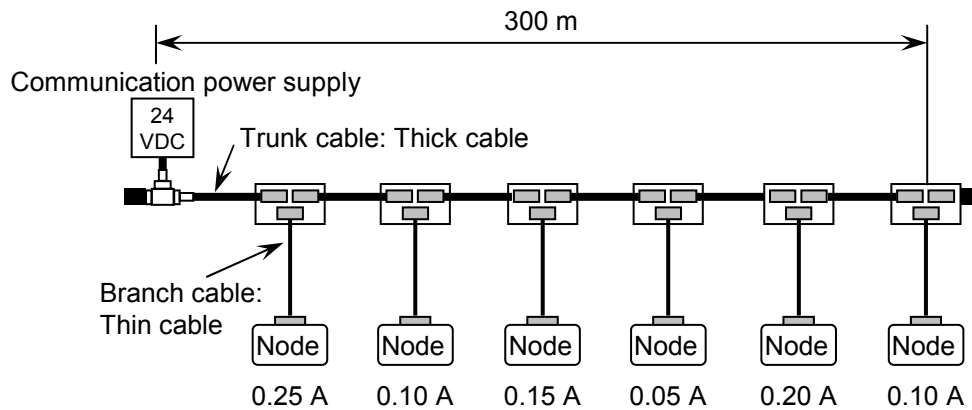

Figure 3-22 Example of a Power Supply and Nodes Connection for Method 1

Total current consumption of the nodes:  $0.25+0.10+0.15+0.05+0.20+0.10=0.85$  A

Total length of power cables: 300 meters

Maximum current of the thick cable (300 m): 1.03 A (found on the “trunk cable length vs. maximum current” graph for thick cables)

In this example, as the total current consumption of the nodes does not exceed the maximum current capacity found on the graph, it is apparent that the power supply can feed power to all of the nodes.

- (2) Method 2: Calculating a voltage drop from the resistance of the communication cable and the current consumption by using equations

This method can be used when the result obtained using Method 1 does not meet the given condition. This method calculates a voltage drop from the resistance of a given communication cable and the current consumption of a given set of nodes. In other words, this method calculates voltage drops, based on the actual node arrangement and power supply location, and verifies your plan.

#### Verification using equations

The DeviceNet standard prescribes that the maximum allowable voltage drop in each of the paired power lines (V+ and V-) be 5 V, which is a drop from the specified voltage (24 VDC) of the communication power supply and from the specified input voltage (11 to 25 VDC) of the power to communications devices. Figure 3-23 is a graphical representation of these voltage drops.



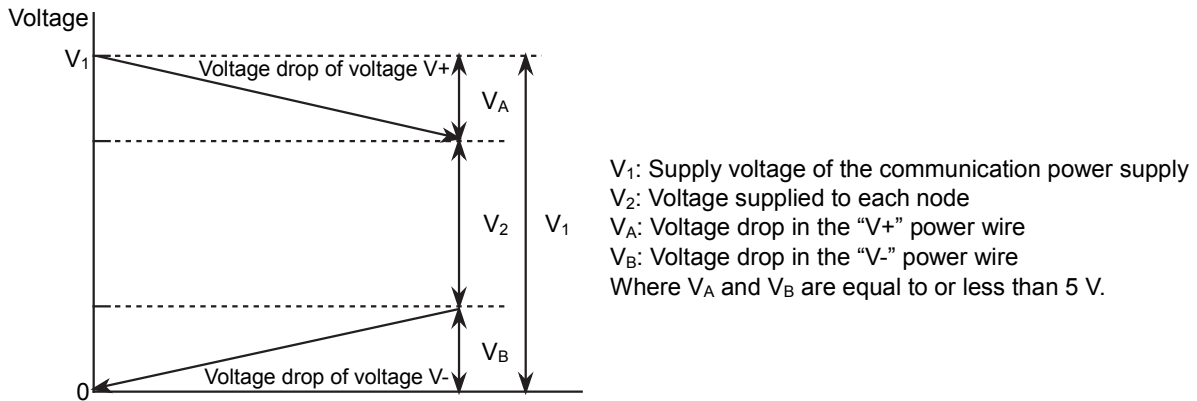

Figure 3-23 Voltage Drops

The DeviceNet standard also prescribes that the supply voltage of the communication power supply be 24 VDC and that its tolerance be 4.0%. Therefore, the voltage  $V_1$  used in actual applications is 23 V, which allows for the tolerance. Further, the voltage drops in the power cables V+ and V- are prescribed to be 5 V or less. Therefore, the voltage  $V_2$  supplied to each node is made equal to or greater than 13 V. This voltage has an adequate margin, compared with the minimum supply voltage (11 V) supplied to each node.

The permissible voltage drop (5 V) in each of V+ and V- consists of a permissible voltage drop in the trunk cable and that in the branch cable(s), which are calculated as follows:

- Calculation of a permissible voltage drop in the branch cable(s)

The current,  $I$ , flowing through the branch cable(s) is calculated from the maximum current capacity and the maximum allowable branch cable length of 6 m, as follows:

$$I = 4.57/6 = 0.761 \text{ (A)}$$

The resistance,  $R$ , of the maximum allowable branch cable length is calculated from the thin cable's maximum resistance of 0.069  $\Omega$ /m, as follows:

$$R = 0.069 \times 6 = 0.414 \text{ ( $\Omega$ )}$$

Therefore, the permissible voltage drop in the maximum allowable branch cable length is:

$$IR = 0.761 \times 0.414 = 0.315 \text{ (V)}$$

The final voltage drop in the branch cable(s) is 0.33 V, allowing for a margin.

- Calculation of a permissible voltage drop in the trunk cable

The permissible voltage drop in each of the power wires (V+ and V-) in any DeviceNet system is prescribed to be 5 V, so the permissible voltage drop in the trunk cable is calculated by:

$$5.0 - 0.33 = 4.67 \text{ (V)}$$

Based on the above calculated values of the permissible voltage drop in the trunk cable (4.67 V) and permissible voltage drop in the branch cable(s) (0.33 V), you can perform verification, as described below.

- Verification expression of a voltage drop in the trunk cable

$$\Sigma(L(n) \times R(c) + N(t) \times 0.005) \times I(n) \leq 4.67$$

where:

L(n): Distance between the power supply and a given node (excluding the branch cable length)

R(c): Maximum cable resistance  
(0.015  $\Omega$ /m for thick cable or 0.069  $\Omega$ /m for thin cable)

N(t): Number of branch taps between the node and the communication power supply

I(n): Current requirement of the communications section of the node

0.005  $\Omega$ : Contact resistance of branch tap

As long as the above verification expression holds true, the power supply at your planned location can supply power to every node on the trunk cable, provided the total current consumption of the nodes does not exceed the maximum current capacity of the trunk cable (8 A for thick cable or 3 A for thin cable). If the above verification expression is found false, take the following measures:

- Replace the thin cable (if used) with a thick cable and evaluate the verification expression again.
- Move the communication power supply toward the center of the trunk cable so that it may come almost between the two equal-size groups of nodes on both sides, and evaluate the verification expression for each of the left and right trunk cables again.
- If the total current consumption of the nodes connected to the trunk cable on one side is greater than that of the nodes on the other side, move the power supply toward the farthest end of the trunk cable on that side. Then, evaluate the verification expression for each of the left and right trunk cables again.
- Reposition nodes that consume a relatively large amount of current close to the communication power supply, and evaluate the verification expression again.

If the verification expression is still found false after all of the above measures have been taken, divide the power supply system into two or more subsystems and provide a power supply for each of the subsystems.

<Example of using Method 2>

The example below assumes that a single power supply is connected to the center of a trunk cable of 240 m long (120 m on each side), and that the nodes in the entire network have the current consumptions shown below.

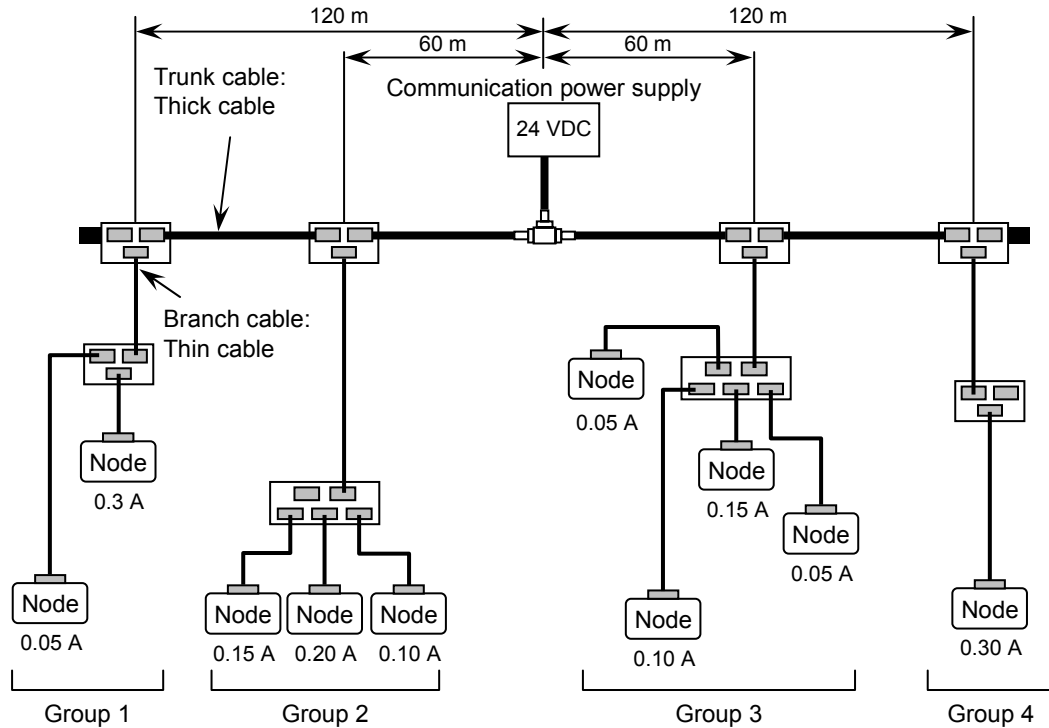

Figure 3-24 Example of a Power Supply and Nodes Connection for Method 2

To calculate the left side of the verification expression, a voltage drop in each group is calculated:

Left side of the trunk cable:

$$\text{Voltage drop in group 1: } (120 \times 0.015 + 2 \times 0.005) \times 0.35 = 0.634 \text{ V}$$

$$\text{Voltage drop in group 2: } (60 \times 0.015 + 1 \times 0.005) \times 0.45 = 0.407 \text{ V}$$

$$\text{Total voltage drop in the left trunk cable} = 0.634 + 0.407 = 1.041 \text{ V}$$

Right side of the trunk cable:

$$\text{Voltage drop in group 3: } (60 \times 0.015 + 1 \times 0.005) \times 0.35 = 0.317 \text{ V}$$

$$\text{Voltage drop in group 4: } (120 \times 0.015 + 2 \times 0.005) \times 0.30 = 0.543 \text{ V}$$

$$\text{Total voltage drop in the right trunk cable} = 0.317 + 0.543 = 0.860 \text{ V}$$

As is obvious from the above, the verification expression holds true for both sides.

Therefore, it is apparent that the power supply can supply power to all the nodes in the network.

#### **NOTICE**

If the power system is divided into two or more subsystems and a power supply is provided for each of the subsystems, do the same verification for each power supply to ensure that it can feed power to the given nodes.

3.4.6 Grounding specification

The grounding of transmission paths must be done at one single point. To meet this condition, you have to insulate electrically the communication section of each node to be connected to the transmission path and ground the individual nodes at one point, as shown below. If more than one communication power supply needs to be used in the network, select one of the power supplies and ground the shield wire and the V- power wire of the transmission line via the selected power supply, as shown below.

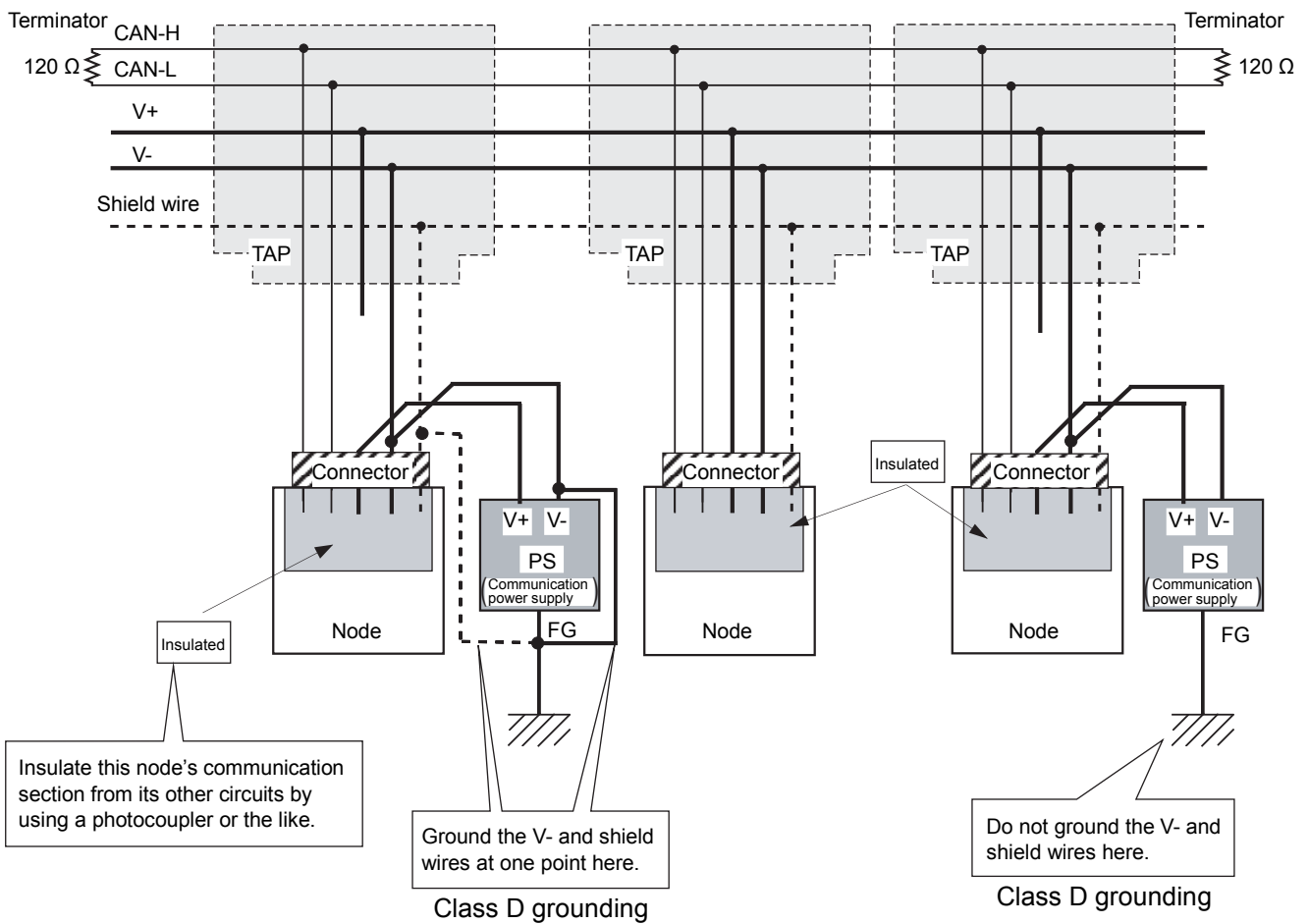

Figure 3-25 Grounding Specification – an Example

### 3 MOUNTING AND WIRING

---

#### 3.4.7 Precautions for use in an electromagnetic noise environment

When using the D.NET module in places where the electromagnetic noise level is high, you are recommended to take the following measures:

- If the D.NET module needs to be connected to noise-inducing equipment, such as an inverter, do the following:
  - Ground the DeviceNet cable at the noise source. As for the S10V controller's FG terminal, it must be grounded at a point away from the grounding point of the noise source.
  - Attach a ferrite core to the DeviceNet cable, which may improve the noise tolerance of the D.NET module. The ferrite core must meet the following conditions:
    - It must attenuate the frequencies of noise generated by the noise source.
    - It must not attenuate the frequency band of transmission signals transmitted over the DeviceNet communication line (at 125 kbps to 500 kbps). However, depending on their properties, some ferrite cores may attenuate such transmission signals significantly, resulting in a communication error. Therefore, care must be taken when attaching a ferrite core to the cable.
  
- If the DeviceNet cable is laid near AC power cables, do the following:
  - The wiring duct or tube in which the laid DeviceNet cable is enclosed must be kept well away from those in which AC power cables are enclosed, and must be grounded separately from the AC power cables.

# 4 OPERATION

## 4 OPERATION

### 4.1 Before Starting Up the System

The D.NET system, which is available as an option, is used to start the operation of the D.NET module. The D.NET system is a man-machine tool that sets communication setup information for communications between the D.NET module and DeviceNet devices in the user system.

#### 4.1.1 System configuration

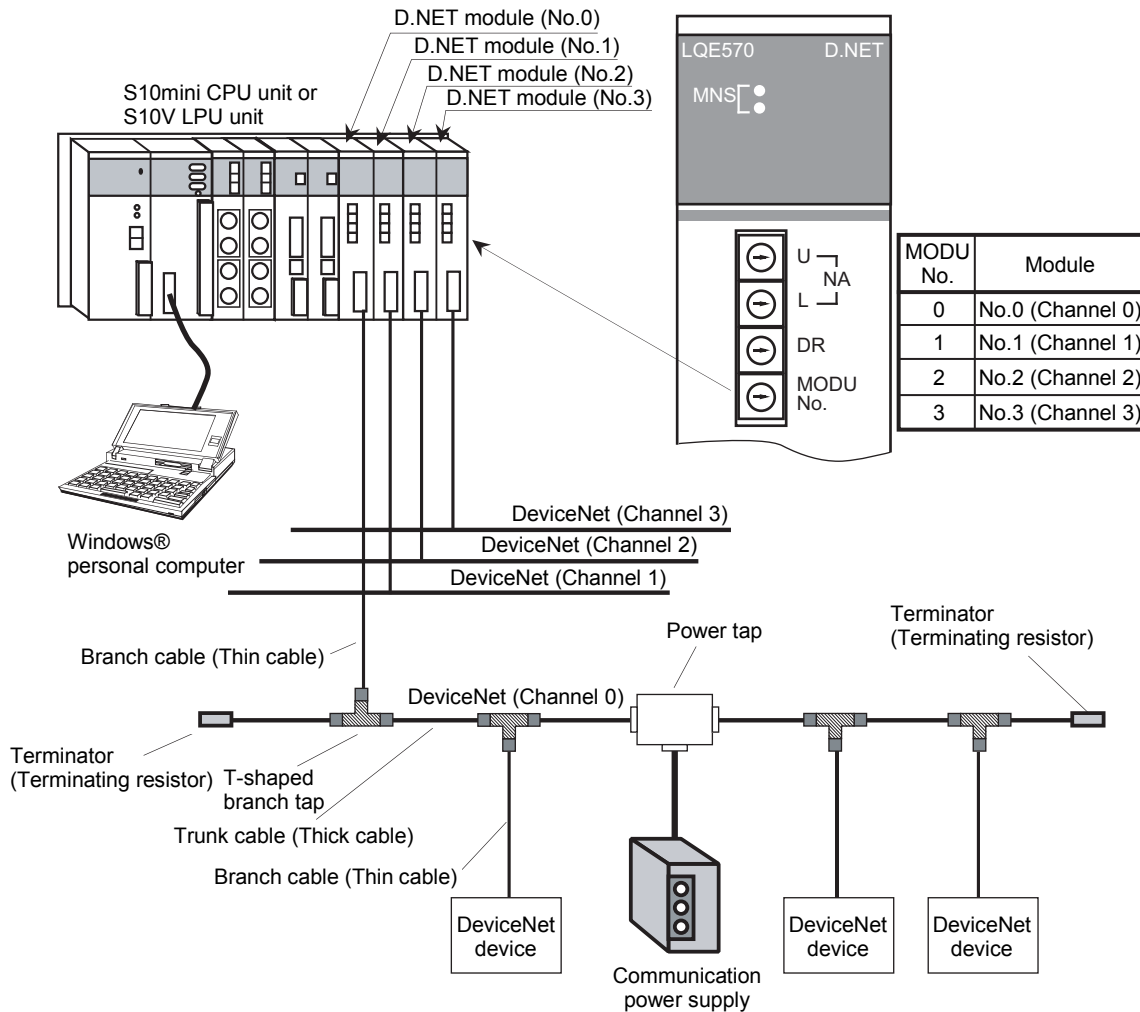

Figure 4-1 System Configuration

### NOTICE

- Be sure to operate the NA (Node Address), DR (Data Rate), and MODU No. setting switches while the D.NET module is powered off. If any of the switches is operated while the D.NET module is powered on, the D.NET module will get into trouble.
- When mounting only one D.NET module in the CPU or LPU unit, be sure to set its module number (MODU No.) to "0".
- When mounting two or more D.NET modules in the CPU or LPU unit, be sure to set the MODU No. of one of the modules to "0".

## 4.2 Starting Up the System

### 4.2.1 Procedure to start up the D.NET system

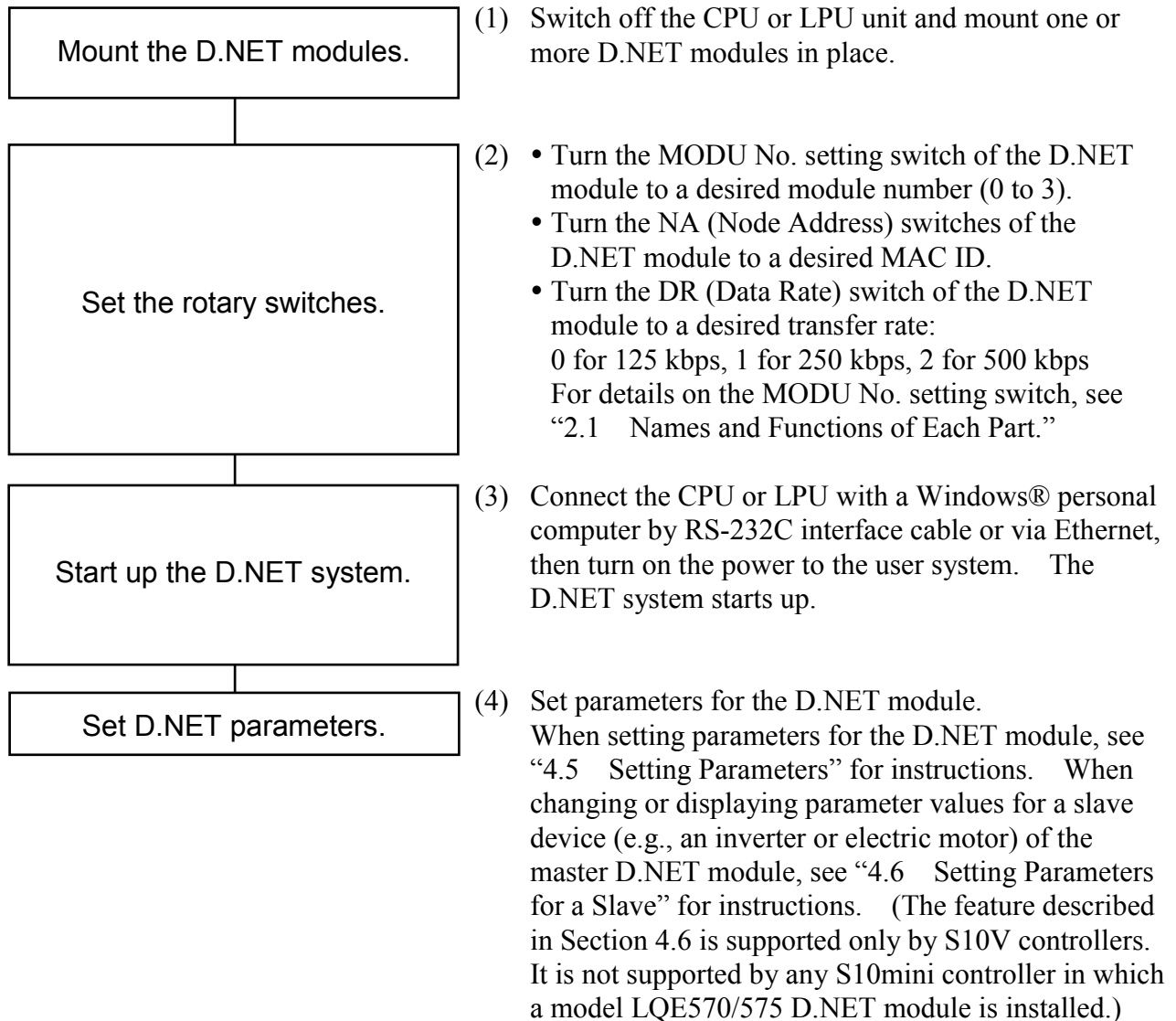

Before starting it up, you have to install the D.NET system on a Windows® PC. This can be accomplished by using a system CD, entitled “D.NET System for Windows®,” which is sold separately. Run the setup program stored on the system CD and install it. For details, see “4.17.1 Installing the system.”

### **NOTICE**

The D.NET system can be used only when the CPU or LPU unit is connected to the Windows® personal computer. You cannot set any parameters while the CPU or LPU unit is not connected to such a personal computer.



## 4 OPERATION

### 4.2.2 Function organization of the D.NET system

#### (1) Function organization for S10mini controllers

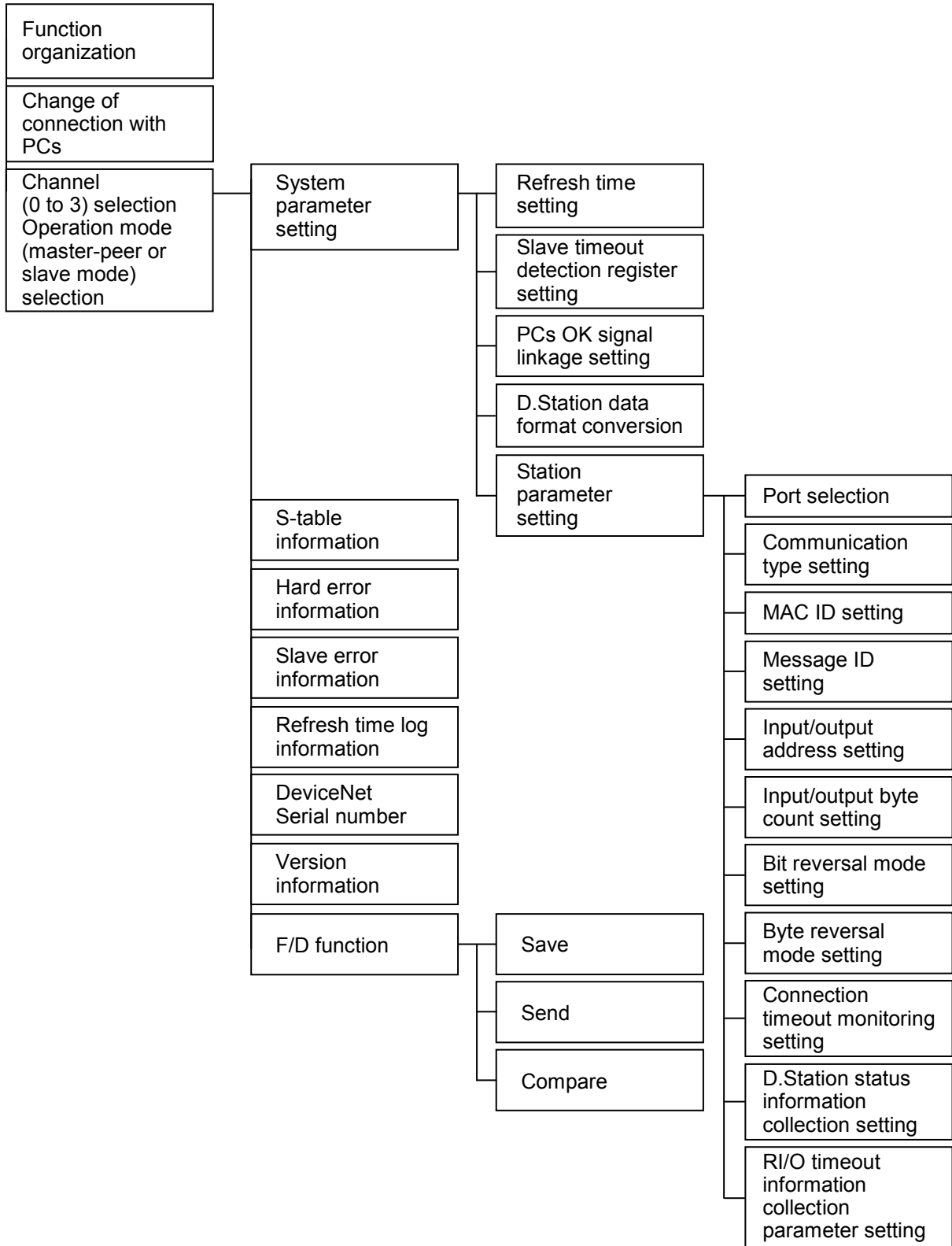

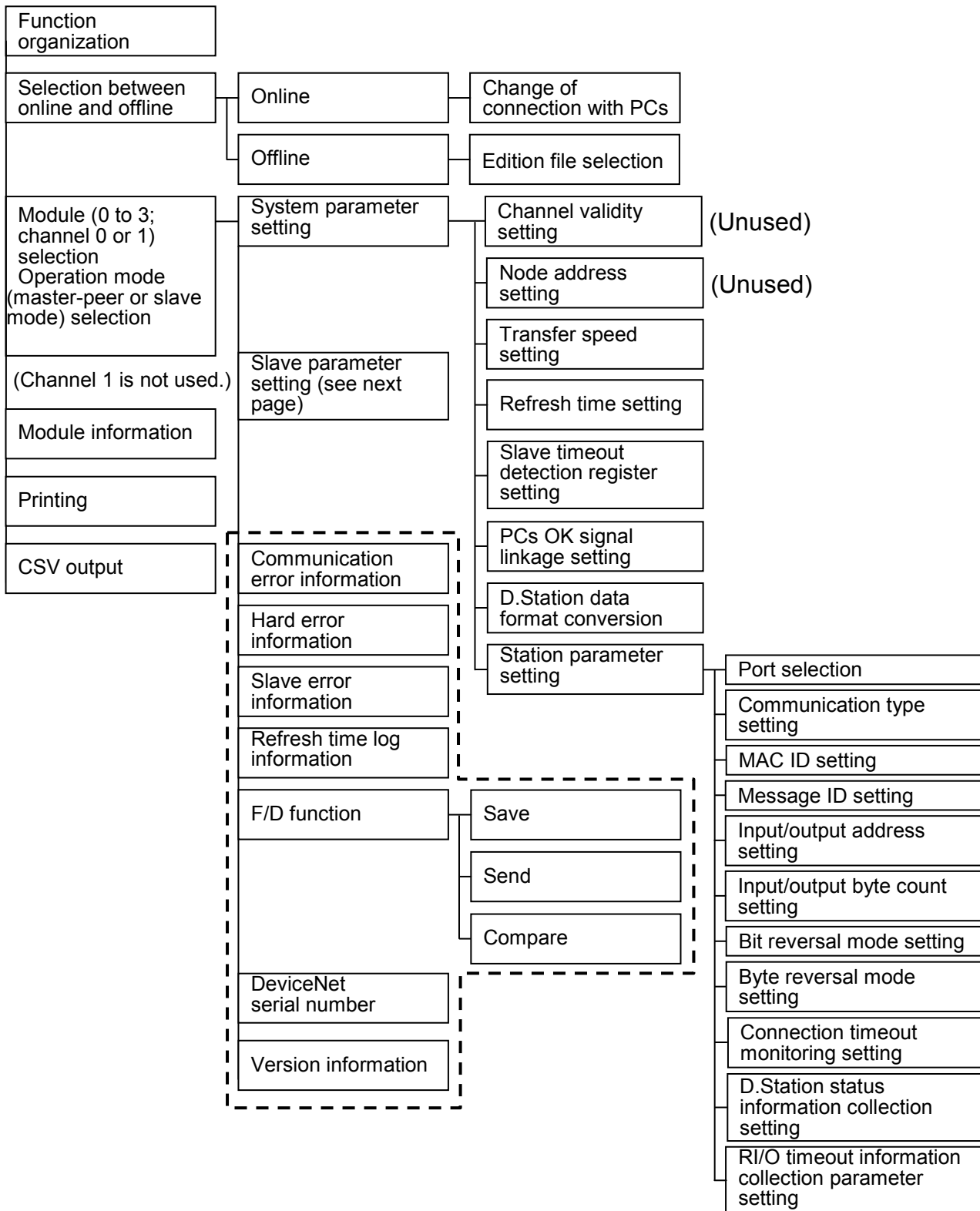

(2) Function organization for S10V controllers

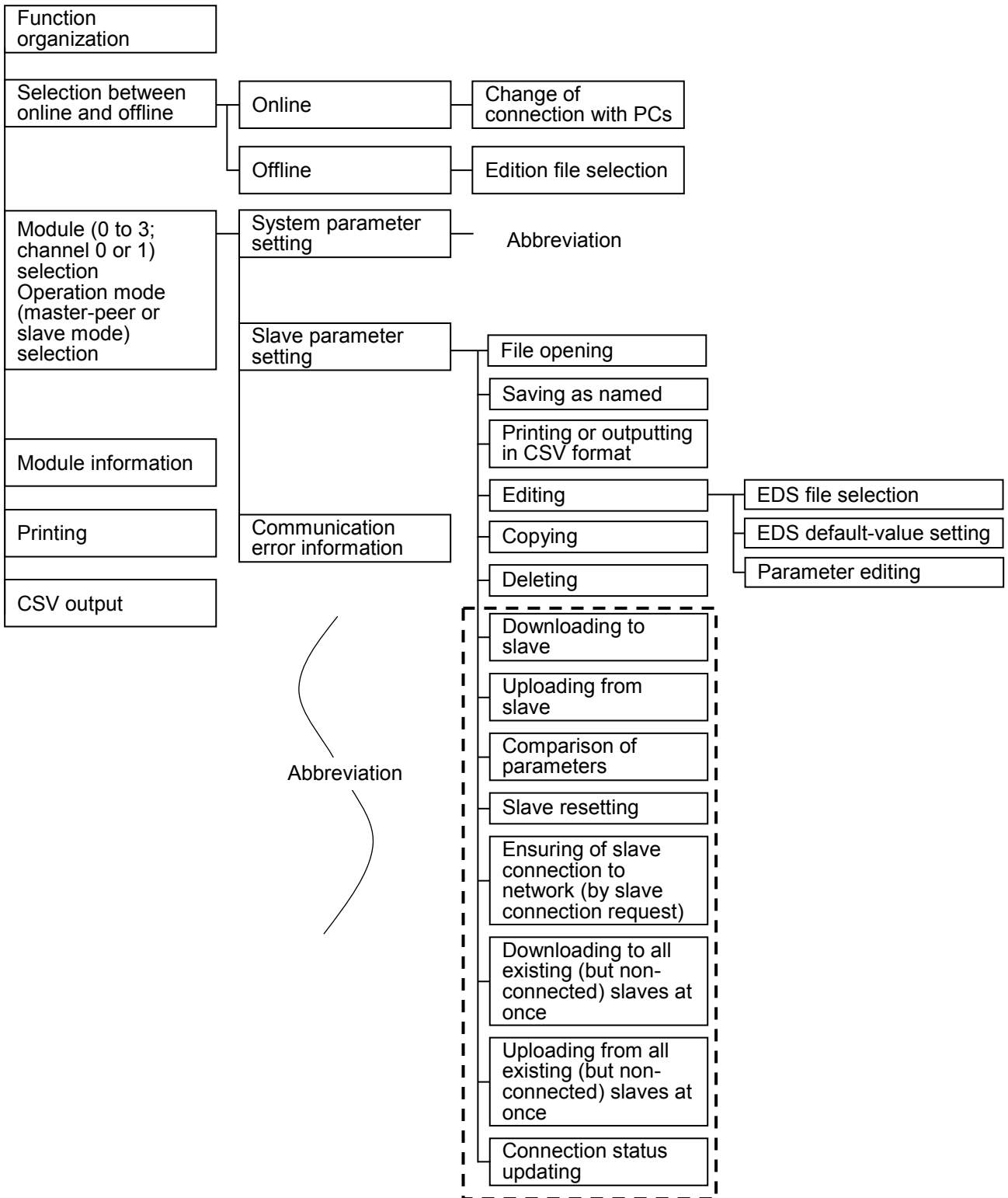

 : Usable only when the D.NET system is running in online mode.

# 4 OPERATION



 : Usable only when the D.NET system is running in online mode.

### 4.2.3 Starting up the D.NET system

The D.NET systems for S10mini and S10V controllers are started differently, as described below.

(For the S10mini)

Click the **Start** button in the Windows® desktop and choose [(All) Programs] - [Hitachi S10] - [D.NET system] from the [Start] menu. The D.NET system will then start up and open the dialog box for channel selection as shown below. Alternatively, if you have created a “D.NET system” shortcut icon in the desktop, just double-click the icon. The channel selection dialog box will then open.



Figure 4-2 Channel Selection Dialog Box

(For the S10V: starting it up in online mode)

(1) Click the **Start** button in the Windows® desk top and choose [(All) Programs] - [Hitachi S10V] - [S10V D.NET SYSTEM] from the [Start] menu. The D.NET system then starts and displays its main window as shown below. Alternatively, if you have created an “S10V D.NET system” icon on the desk top, just double-click the icon. The S10V D.NET system’s main window then appears. At this stage of the procedure, the D.NET system is not connected with the PCs yet.

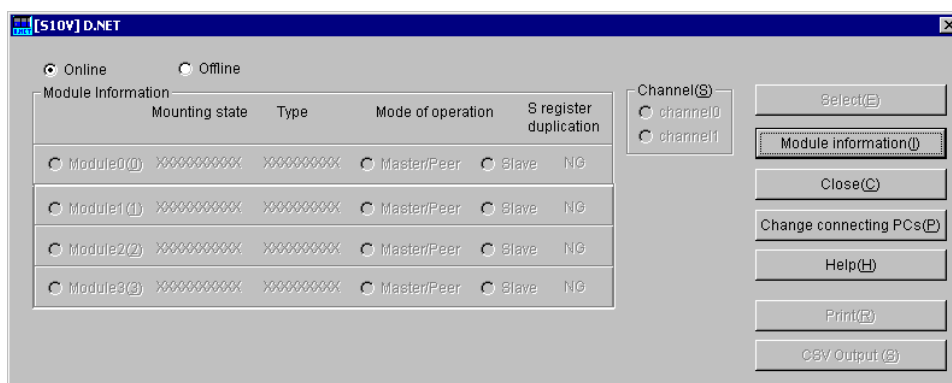

Figure 4-3 The D.NET System's Main Window

## 4 OPERATION

- (2) By clicking the **Change connecting PCs** button in the window, display the [Communication type] window on-screen. When the [Communication type] window appears, specify the desired destination of connection and click the **OK** button (see “4.3 Change of Connection with PCs” for details on the communication type). If you need not change the current connection destination setting, click the **Cancel** button instead.

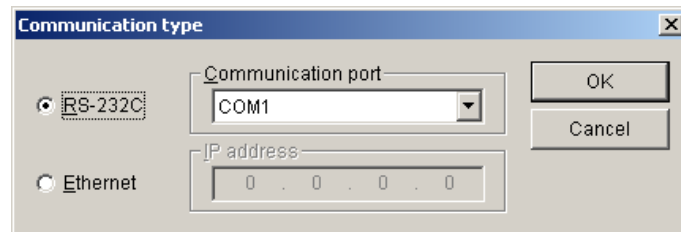

Figure 4-4 [Communication type] Window

- (3) The module/channel selection window as shown below appears. This window shows the current installation information for the D.NET module, such as module mounted or not, D.NET module classification, operation mode used, and S-register duplicated or not. In addition to this installation information, any one or ones of the module numbers 0 through 3 under which a D.NET module is installed are also displayed in gray or black color -- a selected module number and its related D.NET module information are displayed in black color, while a non-selected module number and its related D.NET module information are displayed in gray color. Any module number(s) under which a D.NET module is not installed are grayed out.

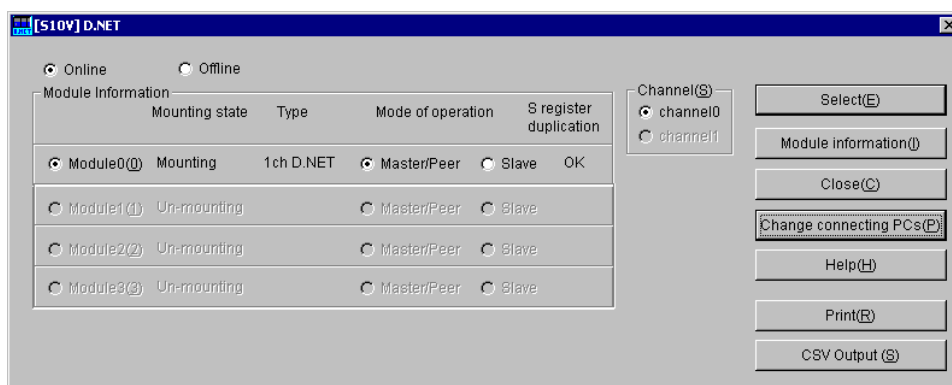

Figure 4-5 The Module/Channel Selection Window -- an Example

Notes:

- If a 1-channel D.NET module(s) are installed along with a 2-channel D.NET module(s) in the same S10V LPU unit, the dialog box shown in Figure 4-6 may be displayed before the module/channel selection window (Figure 4-5), depending on their models.

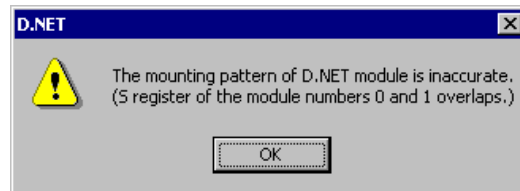

Figure 4-6 The Error Message Dialog Box Reporting on an Intermingled 1-Ch and 2-Ch D.NET Modules Installation

If this dialog box appears, click the  button and change the current setting of the D.NET module's MODU No. setting switch. (If the current mounting position [module number] of the D.NET module also needs to be changed, be sure to power down the LPU before changing it.)

For information on whether a particular combination of 1-ch D.NET modules and 2-ch D.NET modules can be mounted in the same LPU unit, see "1.1 Application."

- If a 2-ch D.NET module is installed in the S10V LPU unit, and an attempt is made to use its channels 0 and 1 in different modes of operation (although this usage is not common), then the dialog box shown in Figure 4-7 will appear. When installing such a D.NET module, remember that its channels 0 and 1 may not be used in a different mode of operation specified for each channel.

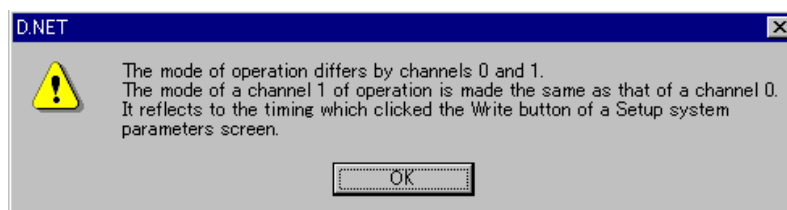

Figure 4-7 The Error Message Dialog Box Reporting on an Attempt to Use Channels 0 and 1 in Different Modes

## 4 OPERATION

(For the S10V: starting it up in offline mode)

The procedure described below enables you to create a setup information file (with the file extension “.pse”) for the D.NET module and edit it, all in offline mode, even if the actual target machine is not present in your user system. To send the setup information file prepared this way to the target machine, first place the D.NET system into online mode and then send it by using the F/D function (see “4.11 F/D Function” for details).

- (1) Display the D.NET system’s main window on-screen by performing the same action as you do in Step (1) of the procedure described under “(For the S10V: starting it up in online mode).”
- (2) Choose the [Offline] radio button. The **Change connecting PCs** button is then replaced by the **Edition file select** button.

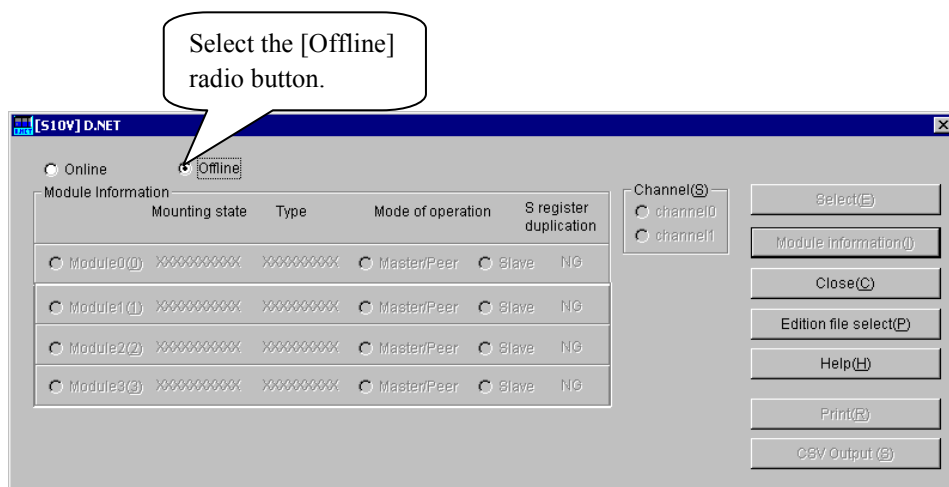

Figure 4-8 Selecting the [Offline] Radio Button

- (3) Click the **Edition file select** button and choose the desired D.NET setup information file you want to edit in offline mode.

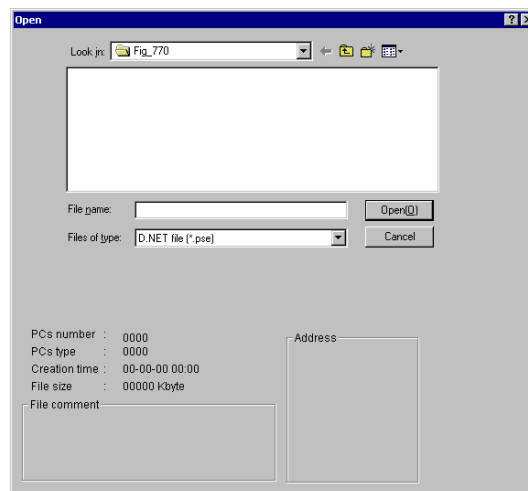

Figure 4-9 Selecting the Edition File You Want to Edit

**NOTICE**

- Users of this product must be familiar with the Windows® environment and user interface. The D.NET system is designed according to the Windows® standards, so this manual that comes with it is intended for those users whose are familiar with basics on how to use the Windows® operating system.
- If you want to use the D.NET system on a PC having suspend function, turn off the suspend function. If the suspend function comes into operation during the execution of the D.NET system, the D.NET system may malfunction.



### 4.3 Change of Connection with PCs

This function selects a specified type of communication for use between the CPU or LPU module and the personal computer.

- (1) From the startup dialog box as shown below, click the **Change connecting PCs** button.

(For the S10mini)



Figure 4-10 Channel Selection Dialog Box

(For the S10V)

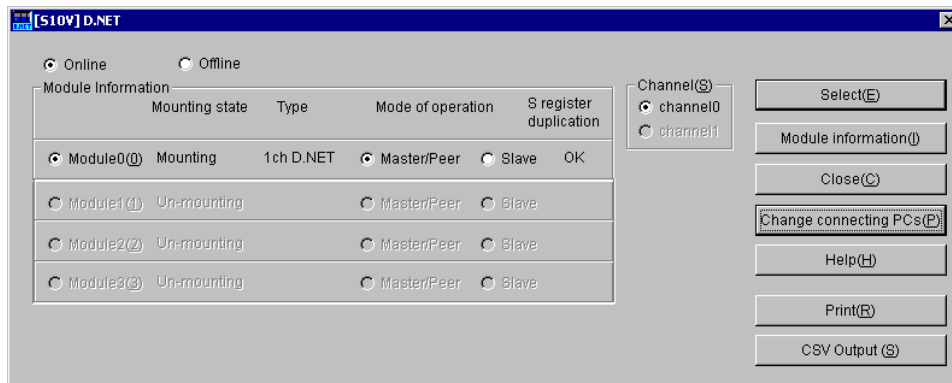
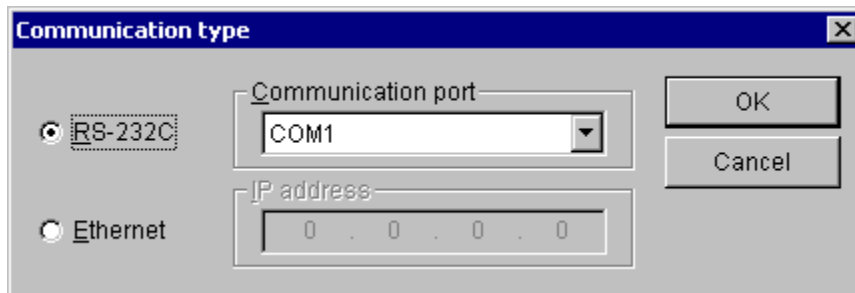

Figure 4-11 Module/Channel Selection Dialog Box

(2) Select the desired communication type.

- Selection of RS-232C connection

Click the [RS-232C] radio button, click the “Down” arrow of “Communication port”, and select a communication port from the pull-down menu. Select one from among the ports COM1 through COM4.



- Selecting Ethernet

Click the [Ethernet] radio button and enter an appropriate IP address.

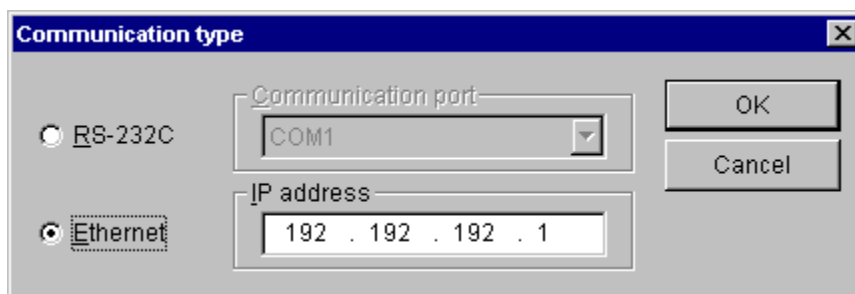

For more information about Ethernet connection, refer to the following manuals:

- HARDWARE MANUAL, ET.NET (manual number SME-1-103)
- USER'S MANUAL, ET.NET (manual number SVE-1-103)
- USER'S MANUAL, CMU (manual number SVE-1-110)

4.4 Channel and Operation Mode Selection

- (1) Select the desired channel number (matching the MODU No. setting in the D.NET module) and mode of operation in the channel selection dialog box (for the S10mini) or the module/channel selection dialog box (for the S10V).

The operation modes and communication types that can be selected are listed below. (For details on the available communication types, see “1.2.3 Types of communication.”)

Communication mode	Operation mode	Communication type
Master	Master-peer mode	Poll, bit strobe transmission, and bit strobe reception
Peer	Master-peer mode	Peer transmission and peer reception
Slave	Slave mode	Poll

(For the S10mini)



Figure 4-12 Channel Selection Dialog Box

After you have selected the channel number and mode of operation, click the **OK** button.

(For the S10V)

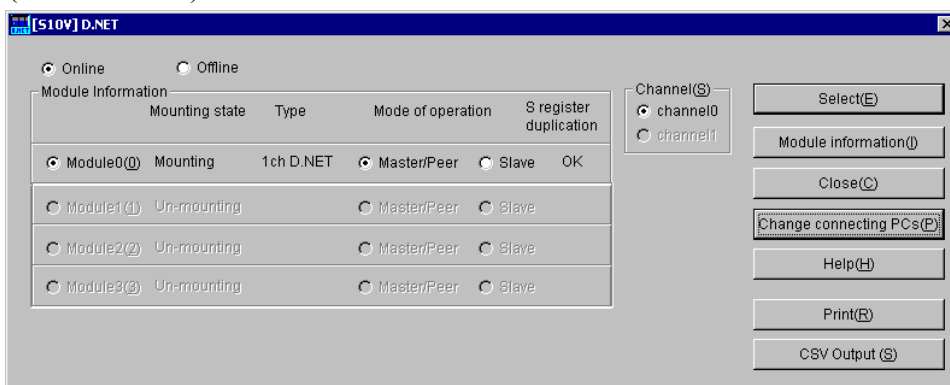

Figure 4-13 Module/Channel Selection Dialog Box

After you have selected the channel number and mode of operation, click the **Select** button.

(2) The D.NET system's basic window opens:

As shown, the title bar of the basic window provides information on the selected microprogram version, module number (for the S10V), operation mode, and channel number for the D.NET module.

(For the S10mini)

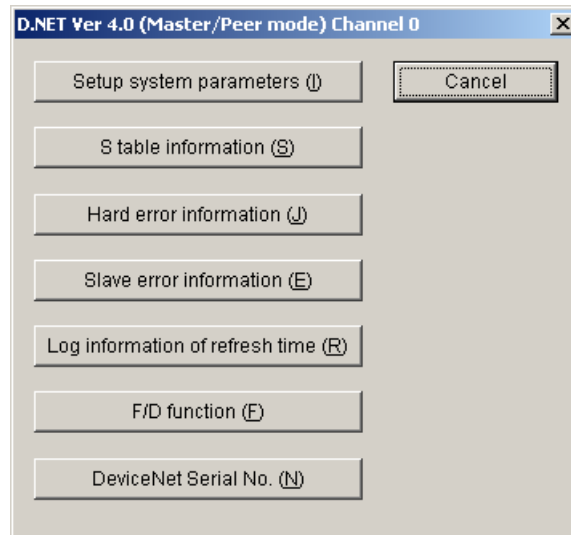

Figure 4-14 The D.NET System's Basic Window

(For the S10V)

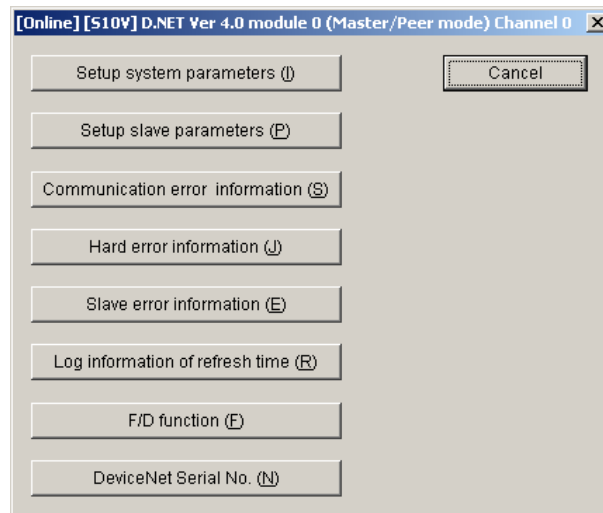

Figure 4-15 The D.NET System's Basic Window

Neither of the Setup slave parameters buttons shown above is effective if the D.NET module installed in your user system does not support slave parameter setting (see “<D.NET modules' Ver-Rev numbers supporting slave parameter setting>” under “4.6.1 Procedure for setting slave parameters” for details). This is also the case when the operation mode selected via the module/channel selection dialog box shown above is “Slave” mode.

## 4.5 Setting Parameters

### 4.5.1 System parameter setting

The system parameters you can set here are mainly as follows: parameters related to I/O data refresh time and parameters related to slave timeout detection registers.

The setting of a refresh time automatically determines the polling cycle for peer transmission and master/slave communication.

- (1) In the D.NET system's basic window, click the **Setup system parameters** button.

Shown below is the D.NET system's basic window for the S10mini.

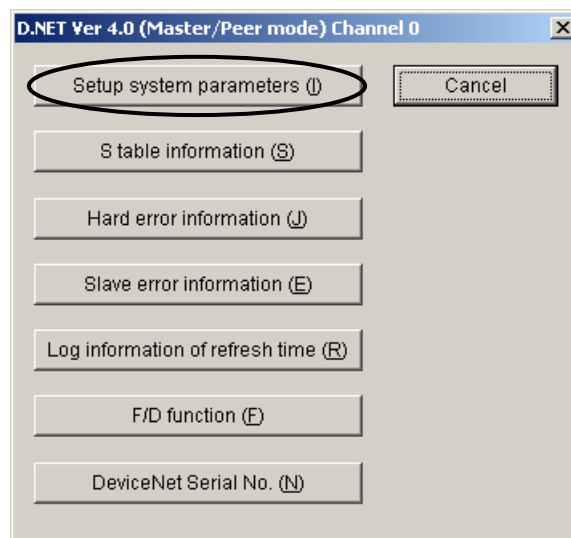

Figure 4-16 The D.NET System's Basic Window

(2) Set the desired system parameters, as shown below.

The [Setup system parameters] window varies in its appearance and content, depending on the operation mode selected as described in “4.4 Channel and Operation Mode Selection.”

<When the “Master/Peer” mode is selected>

(For the S10mini)

Figure 4-17 The [Setup system parameters] Window (master-peer mode)

(For the S10V)

Figure 4-18 The [Setup system parameters] Window (master-peer mode)

## 4 OPERATION

- Peer refresh time setting

Specifies a cycle time at which the D.NET module transfers send/receive data to or from the I/O area in the CPU or LPU during peer-to-peer communication.

Range of setting
3 to 1000 ms (in units of 1 ms)

- Master/Slave refresh time setting

Specifies a cycle time at which the D.NET module transfers send/receive data to or from the I/O area in the CPU or LPU during master-slave communication.

Range of setting
3 to 1000 ms (in units of 1 ms)

The set value of this refresh time automatically determines the peer transmission cycle and the polling cycle for master/slave communication.

The LQE570 and LQE575 use the set value of this refresh time as the transmission cycle.

- Slave timeout detection register setting

Slave timeout detection registers can be used as storage locations to store information on the occurrence of response timeouts (poll and bit strobe) during master-slave communication. (For details, see “5.2 Slave Timeout Flags.”) These storage locations are in the I/O area (setting ranges of 64 points listed below) of the CPU or LPU and can be referenced from ladder programs. If you need not use this function, select the “No use” check box.

Setting range	XW000 – XWFC0 YW000 – YWFC0 JW000 – JWFC0 QW000 – QWFC0 GW000 – GWFC0 RW000 – RWFC0 EW000 – EWFC0 MW000 – MWFC0 LBW0000 – LBWFFC0 (*)
---------------	---

(\*) In the S10mini, this setting range is disabled.

Note: When setting slave timeout detection registers, care must be taken not to set the same range of such registers for more than one D.NET module or channel.

- PCs OK signal linkage setting

Specifies whether to perform communication start/stop control for the D.NET module in linkage with the PCs OK contact output provided via the terminal block of the CPU or LPU module.

If selected: It makes the D.NET module always ready for communication, regardless of the On/Off status of the PCs OK signal. (This is the default factory setting at shipment.)

If deselected: It makes the D.NET module ready for communication only when the PCs OK signal is turned on. When it is turned off, the module becomes unready for communication.

<When the “Slave” mode is selected>

(For the S10mini)

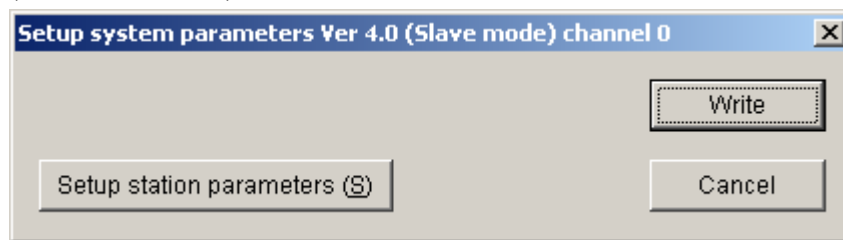

Figure 4-19 The [Setup system parameters] Window (slave mode)

(For the S10V)

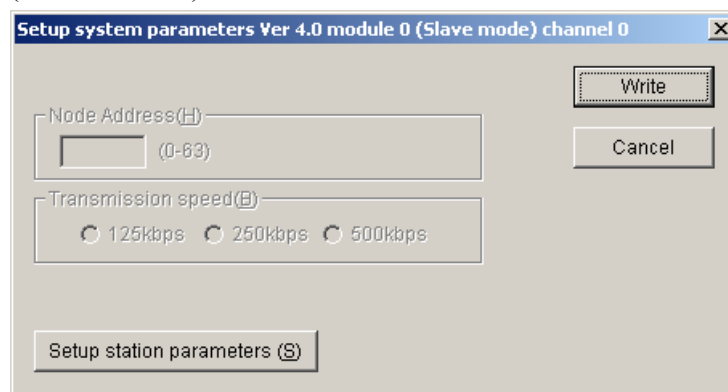

Figure 4-20 The [Setup system parameters] Window (slave mode)



Note: In slave mode, the D.NET module will send back a polling response as soon as it receives a polling request from the master with which it has a connection established.

Therefore, the transmission cycle used by the D.NET module has no relation with the master/slave refresh time used in slave mode. The transmission cycle is determined from the transmission cycle used by the master that has a connection established with the D.NET module running in slave mode.

- Master/slave refresh time setting

Specifies a cycle time at which the D.NET module running in slave mode transfers send/receive data to or from the I/O area of the CPU or LPU.

In slave mode, when the D.NET module receives a polling request from the master, it immediately returns a polling response. Therefore, the refresh time set here is not related to the transmission cycle of the D.NET module. The transmission cycle of the D.NET module is determined from the transmission cycle of the master that establishes a connection with that D.NET module running in slave mode.

The models LQE570 and LQE575 do not require the setting of this cycle time. The reason for this is that they have been improved to transfer receive data to the input area of the CPU or LPU at the time a polling request is received from the master and to fetch send data from their output area.

### 4.5.2 Station parameter setting

The [Setup station parameters] window varies in its appearance and content, depending on the operation mode selected as described in “4.4 Channel and Operation Mode Selection.”

(1) When the “Master/Peer” mode is selected

Communication setup for the D.NET module is made for a specified port by setting its related station parameters. You can specify any port number in the range /01 to /A0 (a total of 160 ports), which can be selected at random.

The D.NET module internally has two fixed-size communication buffers provided for each port: an eight-byte buffer for transmission and an eight-byte buffer for reception.

Therefore, if the set value of the input/output byte count is greater than 8, two or more ports are employed. For example, if the output byte count is set to “24”, the three consecutive ports No.1 through No.3 are employed (because eight bytes per port times 3 is 24 bytes). In this case, all necessary parameters are set only for the port No.1, and no parameters can be set for the ports No.2 and No.3.

Example: Port setup  : Port already set up

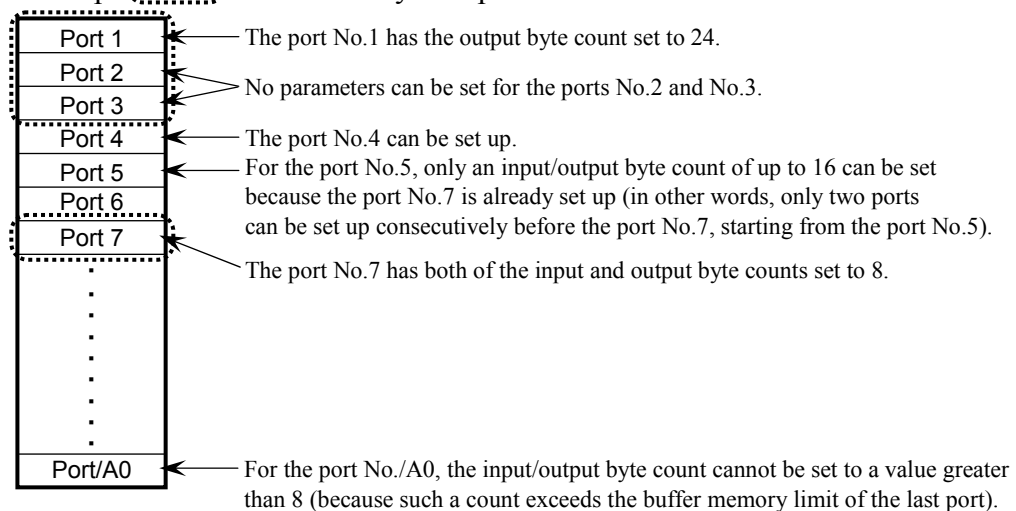

### NOTICE

- If you want to set up two or more ports with their input and output byte counts set to a value greater than 8, care must be taken so as not to cause any overlap between the setups of those ports. For example, if the port No.9 is already set up with its output byte count set to “8”, the port No.8 cannot be set up with its input byte count set to a value greater than 8.
- No setup of a port can exceed the buffer memory limit of the last port (No./A0). For example, you cannot set up the last port with its input byte count set to a value greater than 8 (because it is limited to 8).

## 4 OPERATION

- From the [Setup system parameters] window displayed, click the **Setup station parameters** button. Figure 4-21 shows an example of the [Setup system parameters] window (master-peer mode) for the S10mini.

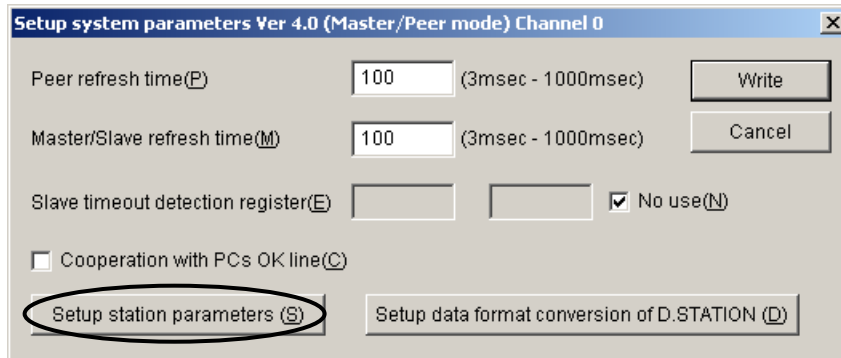

Figure 4-21 The [Setup system parameters] Window (master-peer mode)

- The [Setup station parameters] window as shown below opens. Select the desired port number and click the **Edit** button.

(For the S10mini)

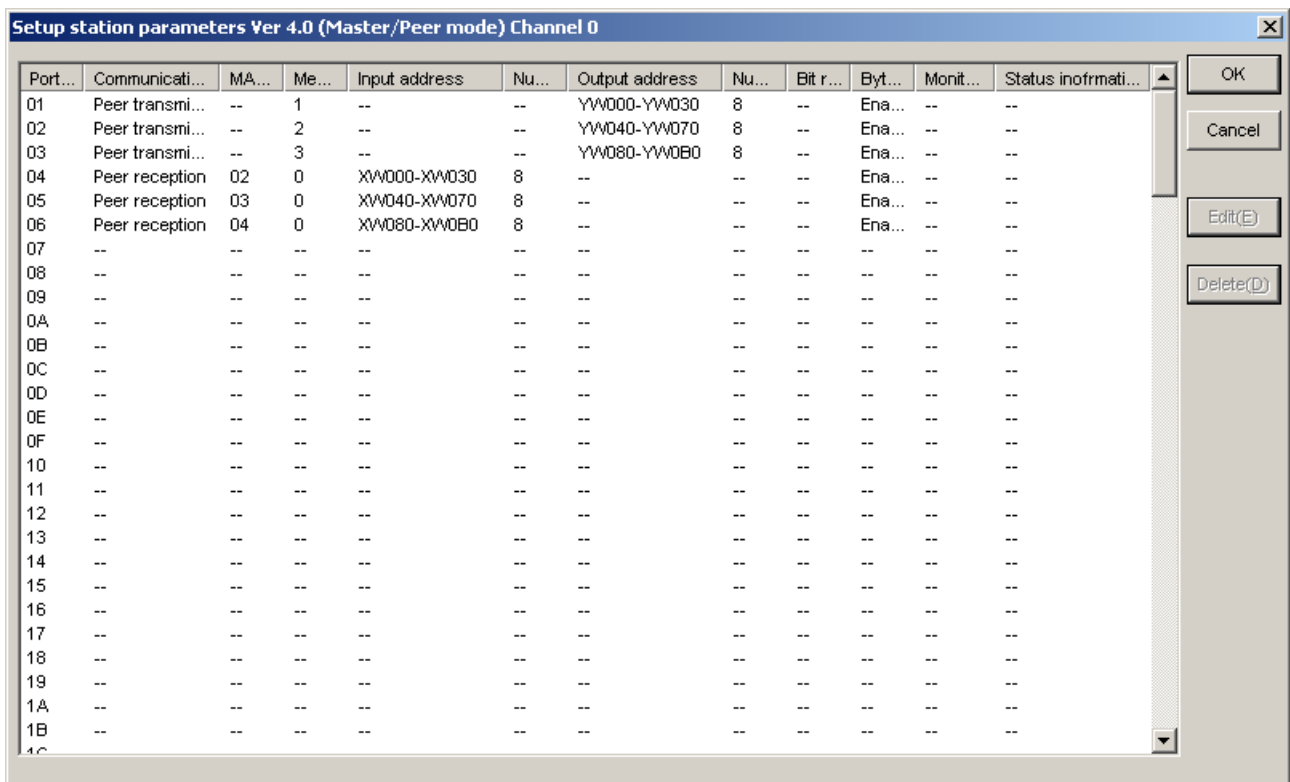

Figure 4-22 The [Setup station parameters] Window (master-peer mode)

(For the S10V)

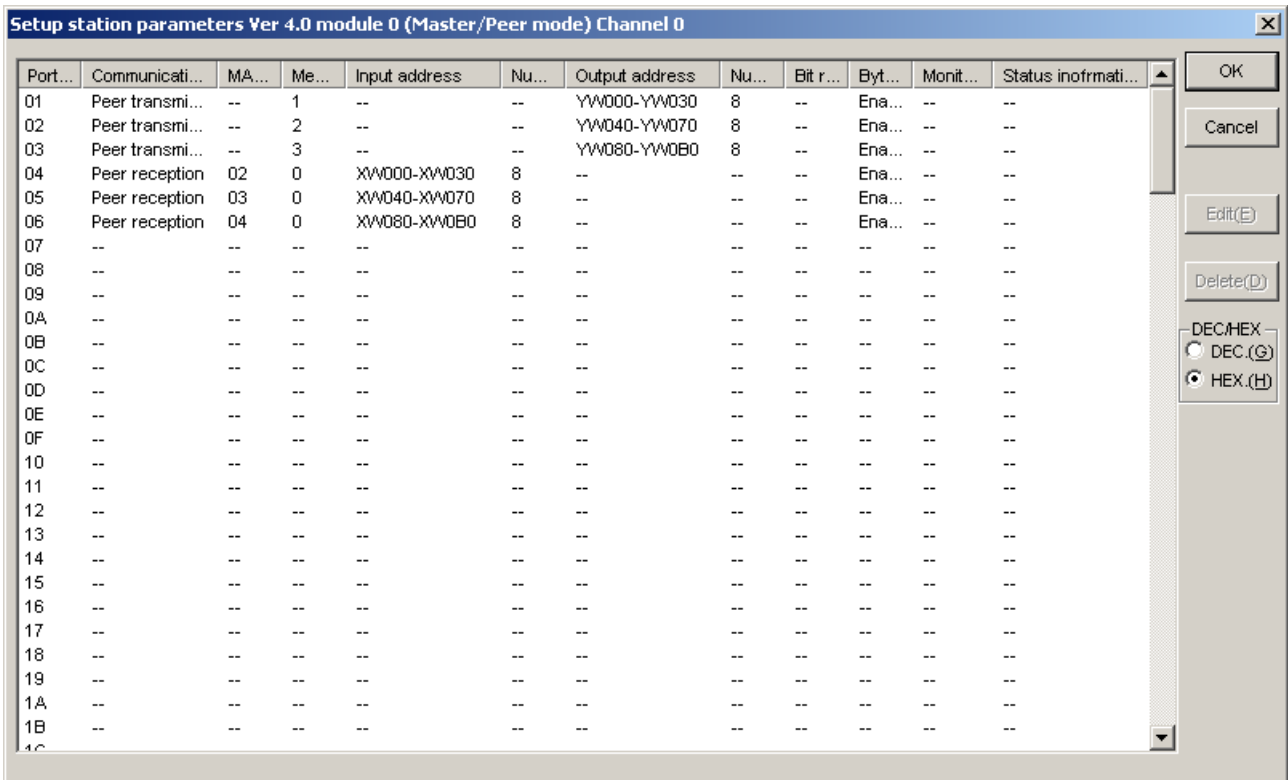

Figure 4-23 The [Setup station parameters] Window (master-peer mode)

In the above window, all of the port numbers, MAC IDs, message IDs, input byte counts, and output byte counts shown are displayed in hexadecimal notation by default. If you select the [DEC] radio button in the DEC/HEX box, they will be displayed in decimal notation. If you select the [HEX] radio button in the DEC/HEX box, they will be displayed in hexadecimal.

Note: The “Monitor connection timeout” values are always displayed in decimal.

## 4 OPERATION

- ③ Choose the port number you want to use, and click the **Edit** button. The [Parameter edit] window opens. Set all necessary station parameters in this window.

(For the S10mini)

The screenshot shows the 'Parameter edit Port01' window. It features a title bar with a close button. The main area contains several sections: 'Communication kind' is set to 'Peer transmission' in a dropdown menu; 'ID' section includes 'MAC ID(M)' (00) and 'Message ID(S)' (1); 'Input address(A)' and 'Input bytes(B)' (000) are shown; 'Output address(D)' is 'YW000 ~ YW030' and 'Output bytes(Y)' is '008'; 'Monitor connection timeout' section has an unchecked checkbox and a text field; 'Collect status information of D.STATION' section has an unchecked checkbox and a text field. 'OK' and 'Cancel' buttons are in the top right. 'Bit reversal mode(W)' is unchecked, and 'Byte reversal mode(X)' is checked.

Figure 4-24 The [Parameter edit] Window 1

(For the S10V)

The screenshot shows the 'Parameter edit Ver 4.0 module 0 (Master/Peer mode) channel 0 Port01' window. It features a title bar with a close button. The main area contains several sections: 'Communication kind' is set to 'Peer transmission' in a dropdown menu; 'ID' section includes 'MAC ID(M)' (00) and 'Message ID(S)' (1); 'Input address(A)' and 'Input bytes(B)' (000) are shown; 'Output address(D)' is 'YW000 ~ YW030' and 'Output bytes(Y)' is '008'; 'Monitor connection timeout' section has an unchecked checkbox and a text field; 'Collect status information of D.STATION' section has an unchecked checkbox and a text field. 'OK' and 'Cancel' buttons are in the top right. 'Bit reversal mode(W)' is unchecked, and 'Byte reversal mode(X)' is checked. A 'DEC/HEX' section has 'DEC(G)' and 'HEX(H)' radio buttons, with 'HEX(H)' selected.

Figure 4-25 The [Parameter edit] Window 2

When specifying station parameters in the above windows, remember the following: Of the setting items displayed in the above windows, the MAC IDs, message IDs, input byte counts, and output byte counts can be displayed in either hexadecimal or decimal notation by selecting the desired radio button in the DEC/HEX box, and can be entered in the selected notation. By default, they are displayed in hexadecimal.

- Communication kind

The communication types that can be selected are as follows:

- No use
- Peer transmission
- Peer reception
- Poll
- Bit strobe transmission
- Bit strobe reception

**NOTICE**

- Only one communication type may be specified for any one single port.
- In master/slave communication, one slave uses 1 to 32 ports. Although a total of 160 port numbers are provided in the system, the maximum number of slaves that can be registered is 63 because the available MAC IDs are limited in number, which are /0 through /3F.

- MAC ID

Is the MAC ID of a communication destination party in peer reception or master/slave communication. With the S10V, you can enter the MAC ID in decimal. (With the S10mini, you can enter it only in hexadecimal.)

Setting range	0 to /3F	(in hexadecimal)
	0 to 63	(in decimal)

## 4 OPERATION

- Message ID

Is any value in the range shown below. The message ID is used in peer-to-peer communication.

With the S10V, you can enter the message ID in decimal. (With the S10mini, you can enter it only in hexadecimal.)

Setting range	0 to /F	(in hexadecimal)
	0 to 15	(in decimal)

Note: If “Peer reception” is selected as the communication type, the data to be received is determined by a combination of the MAC ID and message ID. For example, to receive data from a node for which the MAC ID, communication type, and message ID are set to “/3F”, “Peer transmission”, and “/F”, respectively, use the following settings:

Communication type: Peer reception

MAC ID: /3F

Message ID: /F

### **NOTICE**

Although a total of 160 port numbers are provided in the system, the ports that can be allotted for a particular type of communication are limited as follows:

No.	Communication type	Maximum number of ports allottable
1	Peer transmission	16
2	Peer reception	144
3	Poll	63
4	Bit strobe transmission	1
5	Bit strobe reception	63

The total number of ports allotted must satisfy the following condition:

Peer transmission + Peer reception + Poll + Bit strobe transmission + Bit strobe reception  $\leq$  160

If an input/output byte count is set to a value greater than 8, two or more ports will be used. In this case, those ports must be counted as one port in the above calculation.

A port allotment limitation check is made by the D.NET system, so the user need not do it.

- Input/output addresses

Are the starting and ending addresses of a memory area to store input data or those of a memory area to store output data. Select each such address pair from among those in one of the setting ranges listed below and set it in the input address or output address boxes.

	Input addresses	Output addresses
Setting range	XW000 – XWFF0	XW000 – XWFF0
	YW000 – YWFF0	YW000 – YWFF0
	RW000 – RWFF0	RW000 – RWFF0
	MW000 – MWFF0	MW000 – MWFF0
	GW000 – GWFF0	GW000 – GWFF0
	EW400 – EWFF0	EW400 – EWFF0
	FW000 – FWBFF	FW000 – FWBFF
	DW000 – DWFFF	DW000 – DWFFF
	JW000 – JWFF0	JW000 – JWFF0
	QW000 – QWFF0	QW000 – QWFF0
		SW000 – SWBFF
	/100000 – /4FFFFE (Extension memory) (*1)	/100000 – /4FFFFE (Extension memory) (*1)
	LBW0000 – LBWFFF0 (*2)	LBW0000 – LBWFFF0 (*2)
LWW0000 – LWWFFFF (*2)	LWW0000 – LWWFFFF (*2)	
LXW000 – LXW3FFF (*2)	LXW000 – LXW3FFF (*2)	

(\*1) In the S10V, this setting is not allowed.

(\*2) In the S10mini, this setting is not allowed.

Note: Input/output address (register) pairs must be set without their overlapping with those for other modules or channels.

- Input/output byte counts

Each specifies the size in bytes of data to be transmitted to or from a remote station. Allowable data sizes are listed below.

With the S10V, you can enter input/output byte counts in decimal. (With the S10mini, you can enter these parameters only in hexadecimal.)

As shown below, the setting range varies with the communication type selected.

Communication type	Setting range (in bytes)
Peer transmission	0 to /100 (in hexadecimal) 0 to 256 (in decimal)
Peer reception	
Poll	
Bit strobe transmission	0 or 8 (in hexadecimal)
Bit strobe reception	0 to 8 (in hexadecimal)

If the input/output byte count is set to a value greater than 8, the D.NET module performs fragment reception or fragment transmission.



**NOTICE**

- The input and output byte counts must always be specified. If you need not use them, set them to “0”.
- Specify these parameters only in units of bytes.
- Even when the input/output byte count is set to “1”, a 1-word area will be used in the CPU or LPU memory area defined by a specified input/output address pair.
- If the output byte count is set to a value greater than 8, the D.NET module will perform fragment transmission (split transfer). If the input byte count is set to a value greater than 8, the D.NET module will perform fragment reception. To put it more specifically, if the D.NET module is used in master mode, it first checks the maximum sizes of send data and receive data to be exchanged with a destination slave. Then, if it is found that the destination slave is not in need of a connection for “fragment transmission - fragment reception” or “non-fragment transmission - non-fragment reception,” the D.NET module does not establish a connection with the destination slave. When this occurs, slave error information is generated that includes one of the following slave status values (see “4.9 Slave Error Information”):

/31 (which means that the produced connection size on the slave side supporting I/O Poll connections was found not matching the D.NET module)

/32 (which means that the consumed connection size on the slave side supporting I/O Poll connections was found not matching the D.NET module)

The non-establishment of a connection also occurs when the following condition is not met: maximum transmission data size  $\leq$  maximum reception data size. Also in this case, the generated slave error information includes one of the above slave status values.

If the D.NET module is used in peer mode, it does not check the data size.

You must check the size of data to be exchanged with a destination device in advance.

- Bit reversal mode

Is used when establishing a connection between the S10mini or S10V series controller and a non-Hitachi slave device whose bit I/O numbers are in the opposite order to those used in the S10mini or S10V series. If you want to reverse the bit order of each data word during input or output with the non-Hitachi device, select the “Bit reversal mode” check box. In this case, the string “Enable” is displayed in the “Bit reversal mode” column of the [Setup station parameters] window (see Figure 4-22 [for the S10mini] or Figure 4-23 [for the S10V]). If you need not use the bit reversal mode (e.g., when the slave devices connected to the network are limited to D.NET modules), deselect the check box. In this case, the mark “--” is displayed in the “Bit reversal mode” column. (For more on the bit reversal mode, see “5.7 Parameter Settings Required for Other Company’s DeviceNet Devices Connected.”)

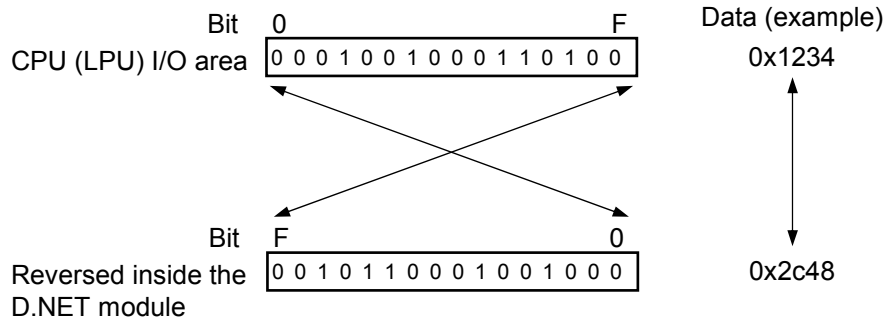

### NOTICE

- Do not use the bit reversal mode when connecting with a slave device (AI/AO) that handles analog data or other numeric data. If it is used, the input/output data will become undefined.
- Do not use the bit reversal mode when connecting with a slave device that handles both digital data and analog data. If it is used, the input/output data will become undefined.

- **Byte reversal mode**

Is used when establishing a connection between the S10mini or S10V series controller and a non-Hitachi slave device whose byte order is opposite to the byte order used in the S10mini or S10V series. If you want to swap the upper and lower bytes of each 16-bit data word during input or output with the non-Hitachi slave device, select the “Byte reversal mode” check box. In this case, the string “Enable” is displayed in the “Byte reversal mode” column of the [Setup station parameters] window (see Figure 4-22 [for the S10mini] or Figure 4-23 [for the S10V]). Usually, the D.NET module is used with this mode selected. (This is the default factory setting at shipment.)

The “Byte reversal mode” check box needs to be deselected only when data cannot be exchanged normally with the non-Hitachi device. If it is deselected, the mark “--” is displayed in the “Byte reversal mode” column.

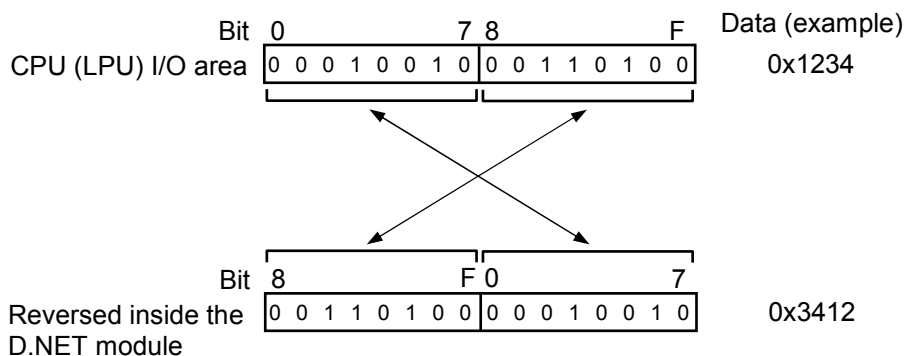

### **NOTICE**

- Any data area specified as the input/output area described under “4.5.3 D.Station data format conversion” is out of the scope of bit reversal processing even when the “Bit reversal mode” check box is selected. (The reason for this is that, even if “bit swap” is specified on the D.Station side, bit reversal is not performed for analog modules, including pulse counters.)
- If you want to establish a connection with the D.Station, ensure that the bit reversal mode and byte reversal mode settings made do not cause any conflict with the data swap setting made with the rotary switches on the D.Station side. For example, if a bit/byte swap setting is made on the D.Station side, check both of the bit reversal mode and byte reversal mode check boxes on the D.NET side.

- **Connection timeout monitoring**

This setting item specifies whether to force a slave device having a connection established with the D.NET module to detect errors in that D.NET module. Setting this item enables you to detect any error in the D.NET module at the slave. For details on how the slave reacts on a D.NET module (master) error, refer to the manual for the slave device.

If deselected: It sets the slave not to detect a connection timeout even if the D.NET module stops communication with it.

If selected: It sets the slave to detect a connection timeout if the D.NET module stops communication with it. In this case, the D.NET module’s NS or MNS LED blinks in red at intervals of 0.5 sec. The subsequent operation of the slave depends on its specifications.

As for the connection timeout monitoring time, it is automatically set to a value that is eight times as large as the set value of the master/slave refresh time described under “4.5.1 System parameter setting.” The time required for the slave to detect a D.NET error is four times as large as the set value of the connection timeout monitoring time.

For example, if the master/slave refresh time is set to 100 ms, the slave detects a connection timeout when its communication with the D.NET module has stopped for 3200 ms.

- **D.Station status information collection**

This item specifies whether to collect status information for a D.Station at the establishment of a connection with it, provided that D.Station is the destination party (slave).

If deselected: It does not cause D.Station status information to be collected. When making communication with any slave other than a D.Station, be sure to remove the check mark.

If selected: It causes D.Station status information to be collected only once at the establishment of a connection with the D.Station (slave) and saved in the area set at a specified information save address. This collection and save operation is automatically performed by the D.NET module.

The setting range of the information storage address is shown below.

Setting range	XW000 – XWFF0 JW000 – JWFF0 YW000 – YWFF0 QW000 – QWFF0 GW000 – GWFF0 RW000 – RWFF0 MW000 – MWFF0 EW400 – EWFF0 FW000 – FWBFF DW000 – DWFFF /100000 – /4FFFFE (Extension memory) (*1) LBW0000 – LBWFFF0 (*2) LWW0000 – LWWFFFF (*2) LXW000 – LXW3FFF (*2)
---------------	--

(\*1) In the S10V, this setting is not allowed.

(\*2) In the S10mini, this setting not allowed.

Note: D.Station status info storage address (register) pairs must be set without their overlapping with those for other modules or channels.

The D.Station status information is two words long (fixed) and its details are as follows.

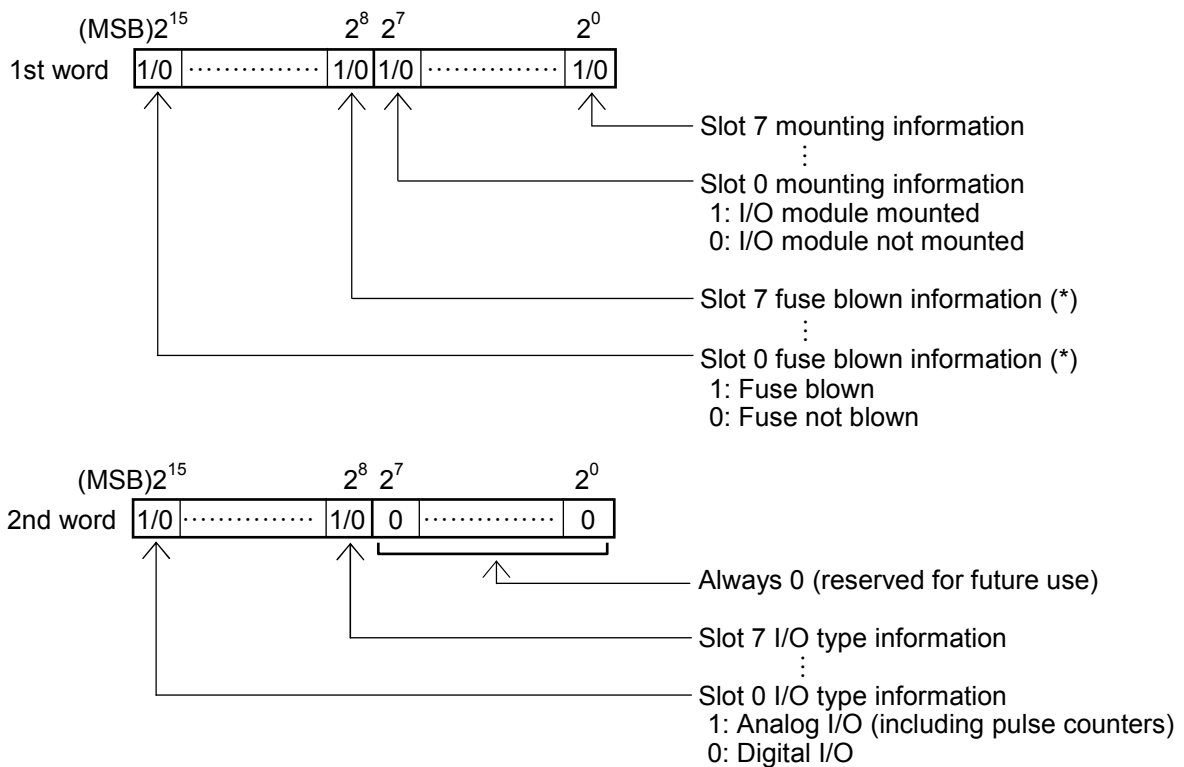

(\* ) This bit is reserved for future use. At present, there is no PI/O module having a fuse mounted and a “fuse not blown” condition is always reported.

**NOTICE**

- This setting item is applicable only when the communication destination party is a D.Station. If this item is selected for any destination party other than the D.Station, a connection is not established due to an error. This error condition can be identified under “4.9 Slave Error Information.” The slave status value in this case is 0x2F, which stands for a failure in acquisition of I/O status information.
- D.Station status information collection is performed only at the establishment of a connection with a D.Station. Accordingly, even if the D.Station’s status changes after the establishment of a connection, this status change is not reflected in the D.NET. If you want to monitor its status constantly, use the D.Station’s I/O error/mounting information-adding function, which adds status information to the input/output data. For details on the I/O error/mounting information adding function, refer to the HARDWARE MANUAL, D.Station (manual number SME-1-119).

④ When all the necessary parameters have been set, click the **OK** button. The [Setup station parameters] window will then open. In this window, click the **OK** button to open the [Setup system parameters] window. (Figure 4-26 shows an example of the [Setup system parameters] window for the S10mini.) When the [Setup system parameters] window appears, click the **Write** button.

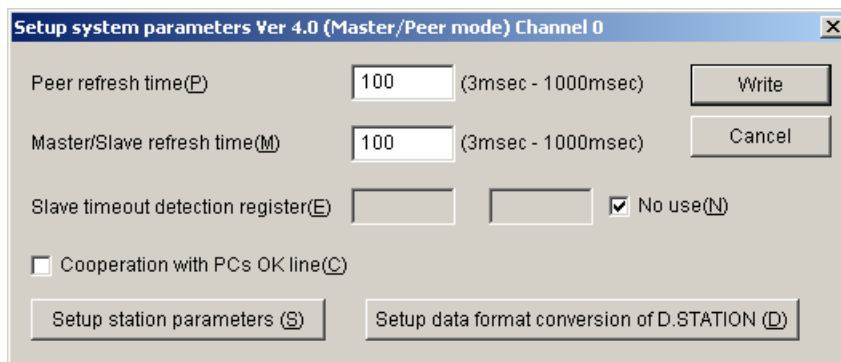
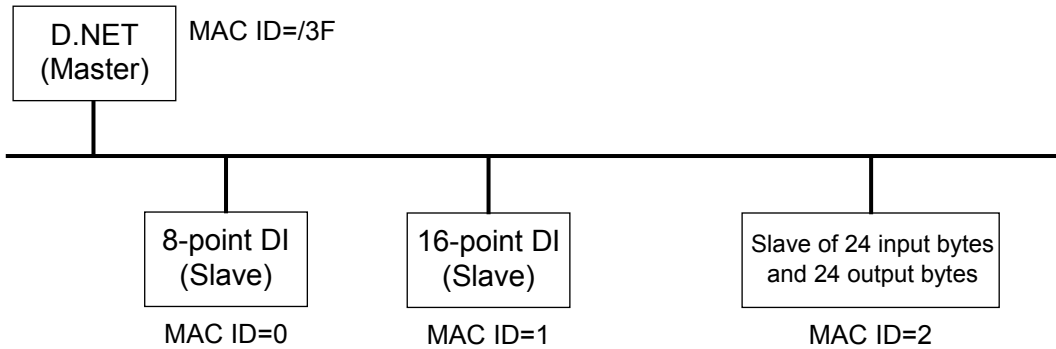

Figure 4-26 The [Setup system parameters] Window (master-peer mode)

Then, according to the on-screen instructions displayed, reset the PCs, or power it down and then up again. This causes the new parameters to be automatically written to the D.NET module.

## (2) Example of setting station parameters

Given the configuration shown below, you could perform bit strobe communication with the two slaves identified by MAC ID = 0, 1 and polling communication with the slave identified by MAC ID = 2 by setting station parameters as shown below.



## Setting example

Port number	Communication type	MAC ID	Message ID	Number of input bytes	Number of output bytes
01	Bit strobe reception	0	–	1	0
02	Bit strobe reception	1	–	1	0
03	Poll	2	–	/18	/18
04	Poll	–	–	–	–
05	Poll	–	–	–	–
06	Bit strobe transmission	–	–	0	0
07	All subsequent ports are unused.				
⋮					

Three ports are used to handle 24 input/output bytes.

Be sure to set “bit strobe transmission” as the communication type to use bit strobe communication.

**NOTICE**

Be sure to set “bit strobe transmission” as the communication type to use bit strobe communication. If only “bit strobe reception” is set, the D.NET module cannot transfer data to and from the slave. Setting only one port for bit strobe transmission enables data transfer to and from the slave.

## 4 OPERATION

(3) When the “Slave” mode is selected

The slave mode uses only one dedicated port and requires no port selection.

- ① From the [Setup system parameters] window displayed, click the **Setup station parameters** button. Figure 4-27 shows an example of the [Setup system parameters] window for the S10mini.

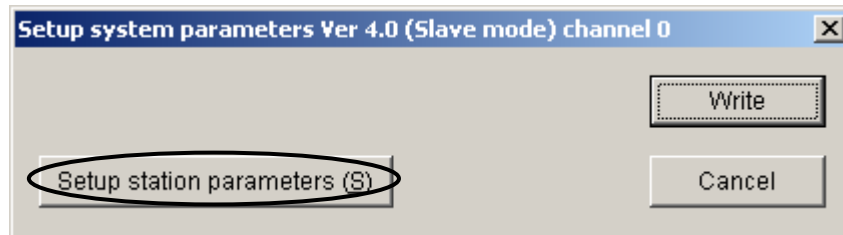

Figure 4-27 The [Setup system parameters] Window (slave mode)

- ② The [Setup station parameters] window as shown below opens.

(For the S10mini)

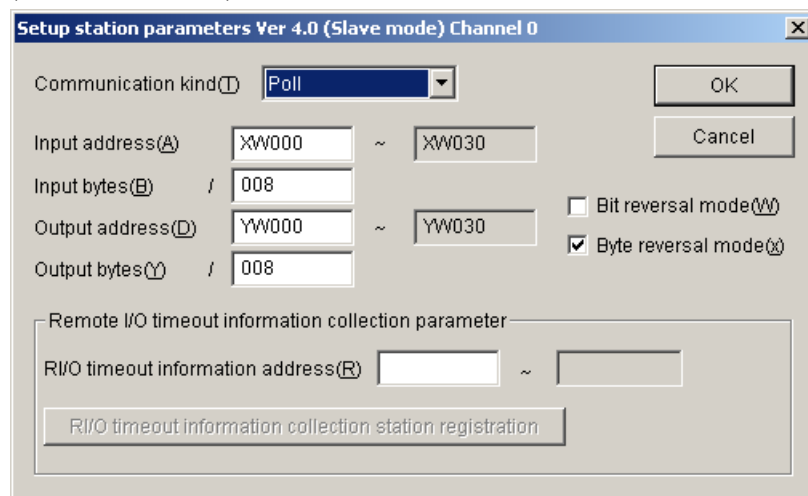

Figure 4-28 The [Setup station parameters] Window (slave mode)

(For the S10V)

The screenshot shows a dialog box titled "Setup station parameters Ver 4.0 module 0 (Slave mode) Channel 0". It contains the following fields and controls:

- Communication kind (T):** A pull-down menu currently showing "Poll".
- Input address (A):** Two text boxes containing "XW000" and "XW030" with a tilde (~) between them.
- Input bytes (B):** A text box containing "008".
- Output address (D):** Two text boxes containing "YW000" and "YW030" with a tilde (~) between them.
- Output bytes (Y):** A text box containing "008".
- Bit reversal mode (W):** An unchecked checkbox.
- Byte reversal mode (X):** A checked checkbox.
- DEC/HEX:** Two radio buttons, "DEC (G)" and "HEX (H)", with "HEX (H)" selected.
- Remote I/O timeout information collection parameter:** A section containing two empty text boxes for "R/I/O timeout information address (R)" and a button labeled "R/I/O timeout information collection station registration".
- Buttons:** "OK" and "Cancel" buttons are located in the top right corner.

Figure 4-29 The [Setup station parameters] Window (slave mode)

Set necessary system parameters according to the instructions given below.

- Communication kind

Select "No use" or "Poll" from the pull-down menu.

### **NOTICE**

If the communication kind is set to "No use", all communication is disabled.



## 4 OPERATION

- Input/output addresses

Are the starting and ending addresses of a memory area to store DeviceNet input data (receive data) or those of a memory area to store DeviceNet output data (send data). Select each such address pair from among those in one of the setting ranges listed below and set it in the input address or output address boxes.

Setting range	XW000 – XWFF0 YW000 – YWFF0 RW000 – RWFF0 MW000 – MWFF0 GW000 – GWFF0 EW400 – EWFF0 FW000 – FWBFF DW000 – DWFFF JW000 – JWFF0 QW000 – QWFF0 /100000 – /4FFFFE (Extension memory) (*1) LBW0000 – LBWFFF0 (*2) LWW0000 – LWWFFFF (*2) LXW000 – LXW3FFF (*2)
---------------	--

(\*1) In the S10V, this setting is not allowed.

(\*2) In the S10mini, this setting is not allowed.

Note: No overlapping is allowed between the input/output address (register) pairs specified for channels.

- Input/output byte counts

Each specifies the size in bytes of data to be transmitted to or received from the master. Allowable data sizes are listed below. With the S10V, you can enter input/output byte counts in decimal. (With the S10mini, you can enter these parameters only in hexadecimal.)

Setting range	0 to /100	(in hexadecimal)
	0 to 256	(in decimal)

If the input/output byte count is set to a value greater than 8, the D.NET module performs fragment reception or fragment transmission.

### **NOTICE**

- The input and output byte counts must always be specified. If you need not use them, set them to "0".
- Specify these parameters only in units of bytes.
- Even when the input/output byte count is set to "1", a 1-word area will be used in the CPU or LPU memory area defined by a specified input /output address pair.
- If the output byte count is set to a value greater than 8, the D.NET module will perform fragment transmission (spilt transfer). If the input byte count is set to a value greater than 8, the D.NET module will perform fragment reception.
- If the D.NET module is used in slave mode, it does not check the data size. You must check the size of data to be exchanged with the master in advance.

- Bit reversal mode

Is used when establishing a connection between the S10mini or S10V series controller and a non-Hitachi master device whose bit I/O numbers are in the opposite order to those used in the S10mini or S10V series. If you want to reverse the bit order of each data word during input or output with the non-Hitachi device, select the “Bit reversal mode” check box. If you need not use the bit reversal mode (e.g., when the master devices connected to the network are limited to D.NET modules), deselect the check box. (For more on the bit reversal mode, see “5.7 Parameter Settings Required for Other Company’s DeviceNet Devices Connected.”)

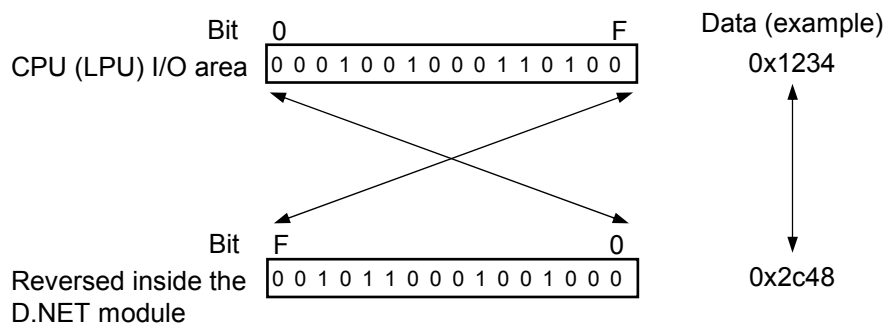

### **NOTICE**

Do not use the bit reversal mode when connecting with a master device that handles analog data or other numeric data. If it is used, the input/output data will become undefined.

- Byte reversal mode

Is used when establishing a connection between the S10mini or S10V series controller and a non-Hitachi master device whose byte order is opposite to the byte order used in the S10mini or S10V series. If you want to swap the upper and lower bytes of each 16-bit data word during input or output with the non-Hitachi device, select the “Byte reversal mode” check box. Usually, the D.NET module is used with this mode selected. (This is the default factory setting at shipment.)

The “Byte reversal mode” check box needs to be deselected only when data cannot be exchanged normally with the non-Hitachi device. (For more on the byte reversal mode, see “5.7 Parameter Settings Required for Other Company’s DeviceNet Devices Connected.”)

## 4 OPERATION

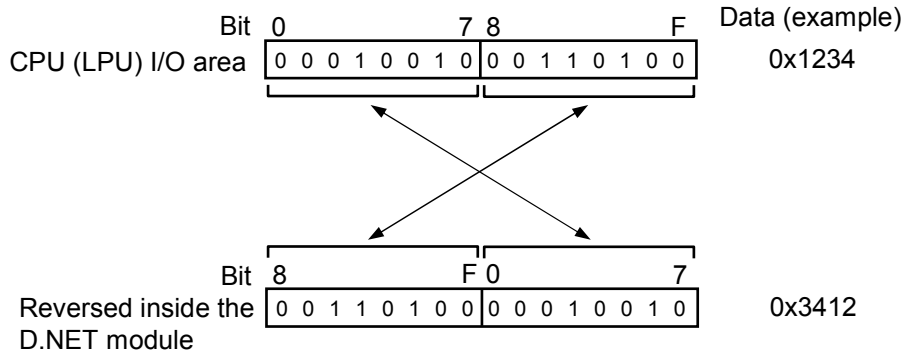

- Remote I/O timeout information collection parameter

This parameter needs to be set only when you want to use the RI/O timeout information collection function – this function forces the D.NET module running in slave mode to collect timeout information from the input and output devices mounted in the S10mini remote I/O station and send it to the master. If you need not use this function, do not set anything as this parameter.

For more information on this parameter, see “(4) Remote I/O timeout information collection function.”

- ③ When all the necessary parameters have been set, click the  button. The [Setup system parameters] window will then open. (Figure 4-30 shows an example of the [Setup system parameters] window (slave mode) for the S10mini.) In this window, click the  button.

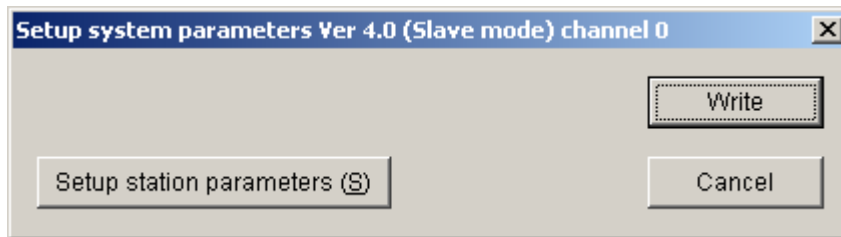

Figure 4-30 The [Setup system parameters] Window (slave mode)

Then, according to the on-screen instructions displayed, reset the PCs, or power it down and then up again. This causes the new parameters to be automatically written to the D.NET module.

## (4) Remote I/O timeout information collection function

## &lt;Outline&gt;

This function is used in cases where the hardware configuration used is as shown below and remote I/O data needs to be sent from the S10mini (or S10V) controller to the master via the DeviceNet. In these cases, this function sends the remote I/O data to the master together with the timeout information for specific remote I/O stations stored in the system registers S380 through S3FF of the S10mini (or S10V) controller.

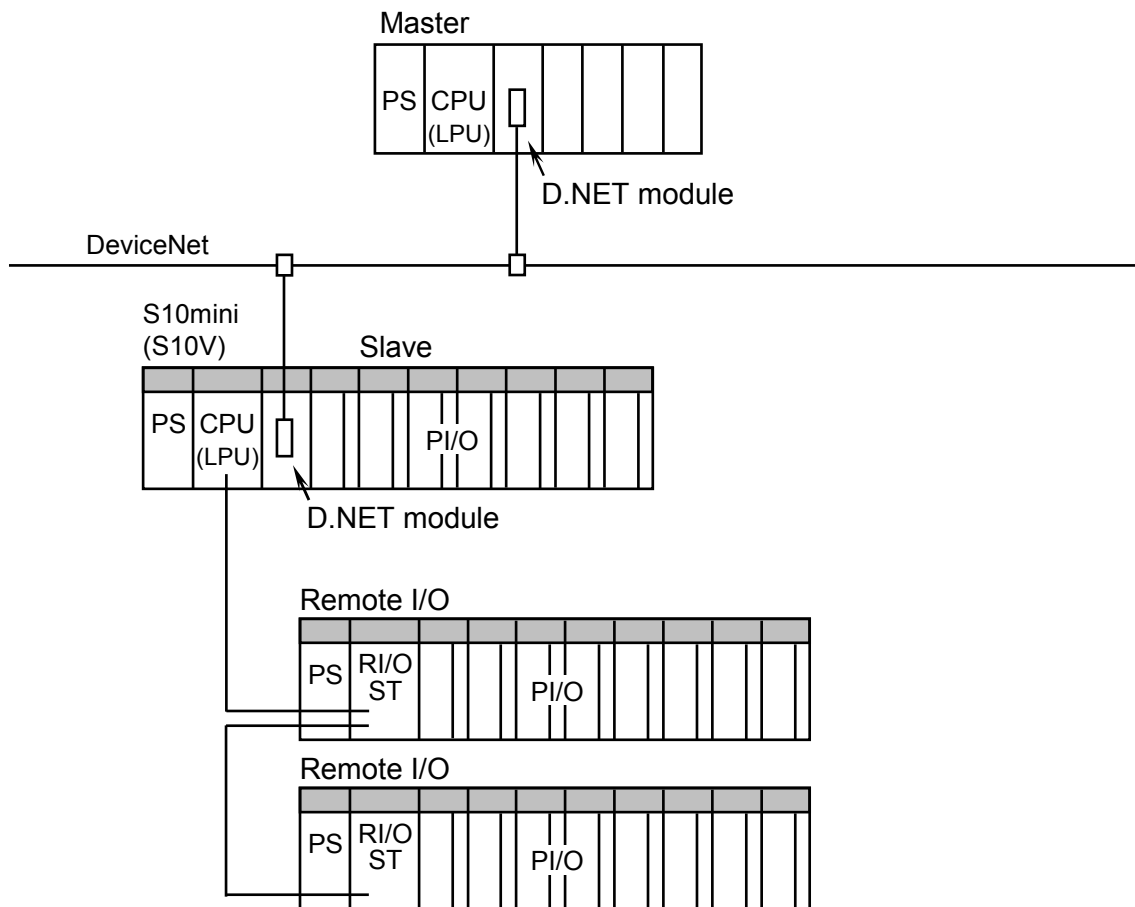

Figure 4-31 A Hardware Configuration Using the Remote I/O Timeout Information Collection Function

## 4 OPERATION

As shown in Figure 4-32, the timeout information for specific remote I/O stations is created, stored at a specified address, and sent to the master together with the remote I/O data, all of which are done by the D.NET module running in slave mode. This enables the master to read the timeout information for the remote I/O. The input and output areas of the master and slave can be freely specified by users for this purpose.

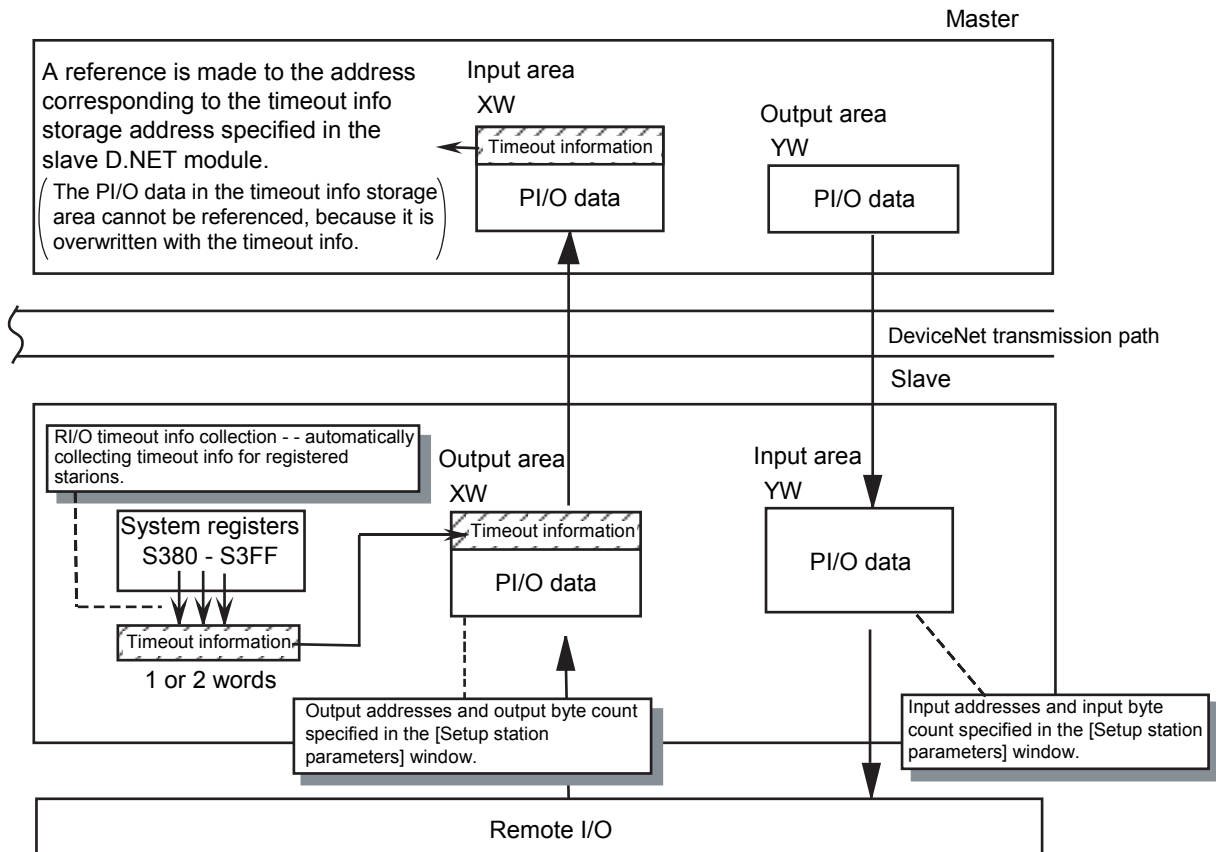
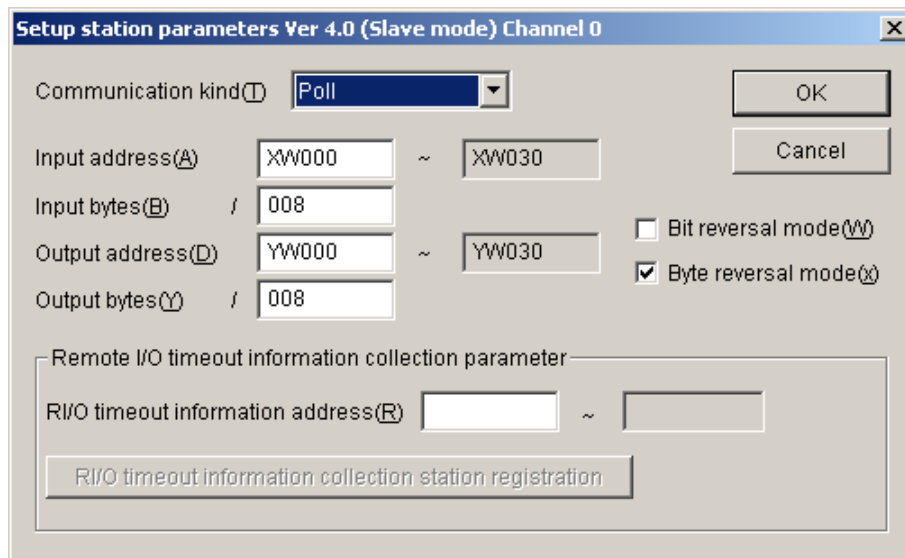

Figure 4-32 The Operation of the Remote I/O Timeout Info Collection Function

<Setting the remote I/O timeout information collection parameter>

The remote I/O timeout info collection parameter can be set via the [Setup station parameters] window in slave mode. If you need not use this function, do not set anything as that parameter.

- ① When all of the communication type, input/output addresses, and input/output byte counts have been set via the [Setup station parameters] window, set the remote I/O timeout information collection parameter. (The figure below shows an example of the [Setup station parameters] window [slave mode] for the S10mini.) To accomplish this, specify the desired RI/O timeout information address and click the **RI/O timeout information collection station registration** button to register a station(s).



- RI/O timeout information address

Specifies where to store remote I/O timeout information in the defined output area. The address that can be set for this purpose is in the range of the output area defined by the specified output addresses and output byte count. The above example window shows the parameter settings that could be used to store the timeout information at the address XW000 in the output area ranging from XW000 to XW030.

	Output area
XW000	Timeout information
XW010	I/O data
XW020	I/O data
XW030	I/O data

### **NOTICE**

The timeout information as shown above is 1 or 2 words long, depending upon the number of remote I/O stations registered via the [RI/O timeout information collection station registration] window.

## 4 OPERATION

- ② Via the [RI/O Timeout information collection station registration] window as shown below, register the desired station for which to collect timeout information. To register the station, double-click the desired registration number, or single-click it and then click the **Regist** button.

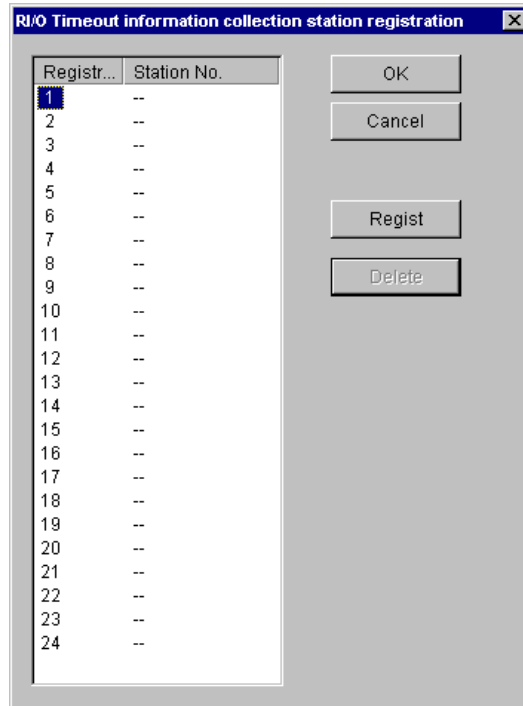

Figure 4-33 The [RI/O Timeout information collection station registration] Window

- ③ The [Station No. Registration] window shown below will open. Register the station number of the remote I/O station via this window.

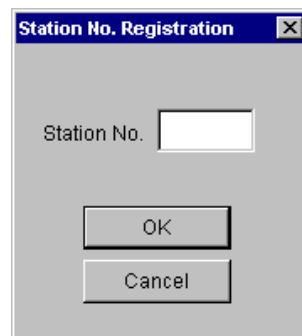

Figure 4-34 The [Station No. Registration] Window

● Station No.

Is the station number of the remote I/O station for which to collect timeout information. (This station number must be the same as that set by the STATION No. setting switch on the remote I/O station module's front panel.)

Setting range	0 to /7F	(in hexadecimal)
---------------	----------	------------------

## &lt;Remote I/O timeout information&gt;

As shown below, remote I/O timeout information is conveyed by specific bits in a 16-bit word that are placed in one-to-one correspondence with the registration numbers registered along with specified station numbers via the [RI/O Timeout information collection station registration] window.

The timeout information conveyed at a time is two words long if 17 or more stations are registered. The reason for this is that remote I/O stations can be registered up to 12 stations per line, that is, a total of 24 stations installed in a distributed fashion can be registered at a time.

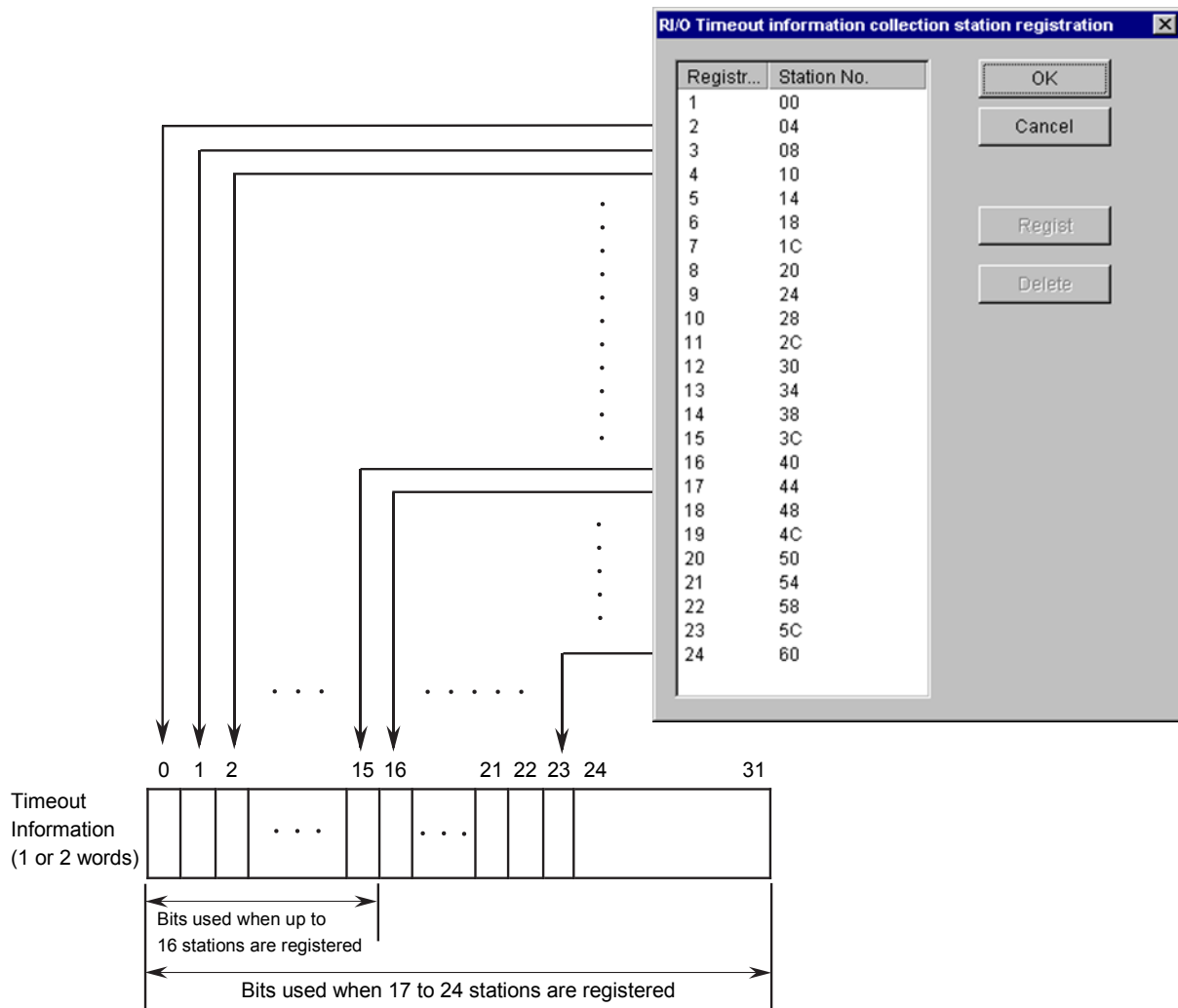
**NOTICE**

- This function is applicable only in transmission (output) in slave mode. (It is not applicable in master-peer mode.)
- The output area in which timeout information is stored cannot be used as an input area for a remote I/O station.
- If the "Bit reversal mode" check box is checked, each word of timeout information is also bit-reversed.



## 4 OPERATION

### 4.5.3 D.Station data format conversion

#### <Outline>

This function converts the input/output data formats used in the D.Station's internally mounted analog modules and pulse counter modules to those used in the D.NET module.

The formats that can be converted are shown below. The CPU or LPU module's internal I/O area to store pulse counter data needs to be specified as an assignment data area in the [Setup data format conversion of D.Station] window (see Figure 4-36).

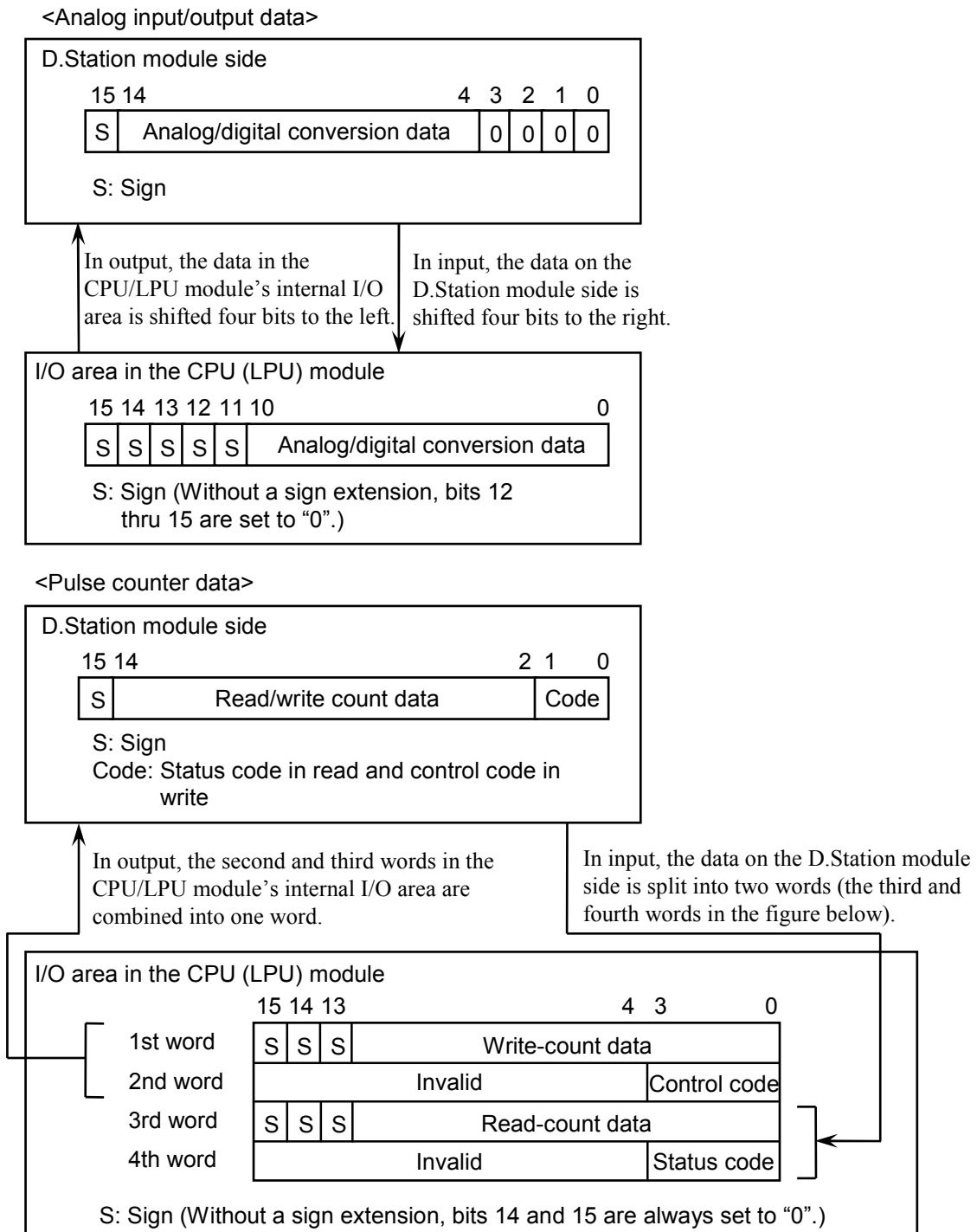

- Control codes of the pulse counter and their meanings  
(Operation mode 1)

Control code	Meaning	What is caused by its setting
8	Counting stop	Stopping the pulse measurement in process.
4	Preset start	Setting the preset value in the counter and starting measurement.
2	Comparison value setting	Setting a comparison value in the comparison register and starting measurement.
1	Latch resetting	Resetting the latched match signal and starting measurement.
Others	Invalid	—————

(Operation mode 2)

Control code	Meaning	What is caused by its setting
8	Counting stop	Stopping the pulse measurement in process.
4	Preset start	Setting the preset value in the counter and starting measurement.
2	Comparison value setting	Sets a comparison value in the comparison register.
1	Latch resetting	Resetting the latched match signal.
Others	Invalid	—————

- Status codes of the pulse counter and their meanings  
(Operation mode 1)

Status code	Meaning	Status
8	Counting stop	Counting is stopped.
4	$R > C$	The comparison value is larger than the count value.
2	$R = C$	The comparison value is equal to the count value.
1	$R < C$	The comparison value is smaller than the count value.

R: Comparison data value

C: Count value

(Operation mode 2)

Status code	Meaning	Status
8	Counting stop	The control code transferred previously is set.
4	Preset start	
2	Comparison value setting	
1	Latch resetting	

For details on the usage of the pulse counter, refer to the instruction manual that comes with that module.

## 4 OPERATION

### <D.Station data format conversion setup>

D.Station data format conversion needs to be set up only in the following case: you want to establish a connection with the D.Station to be used as a slave of the D.NET module, and the data formats used in the AI/AO and pulse counter needs to be converted as outlined under “4.5.3 D.Station data format conversion.” In any other case, do not set anything for such conversion.

- ① Click the **Setup data format conversion of D.STATION** button in the [Setup system parameters] window as shown below. (Figure 4-35 shows an example of the [Setup system parameters] window for the S10mini [master-peer mode]).

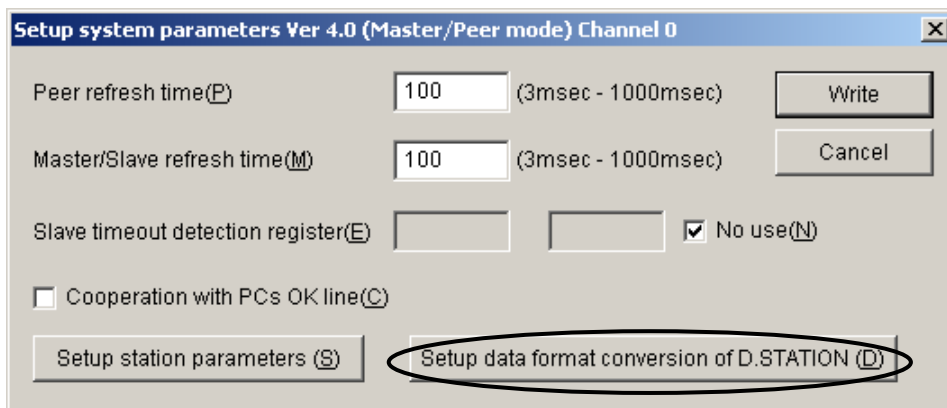

Figure 4-35 The [Setup system parameters] Window (master-peer mode)

- ② The [Convert data format of D.STATION] window as shown below will open.

(For the S10mini)

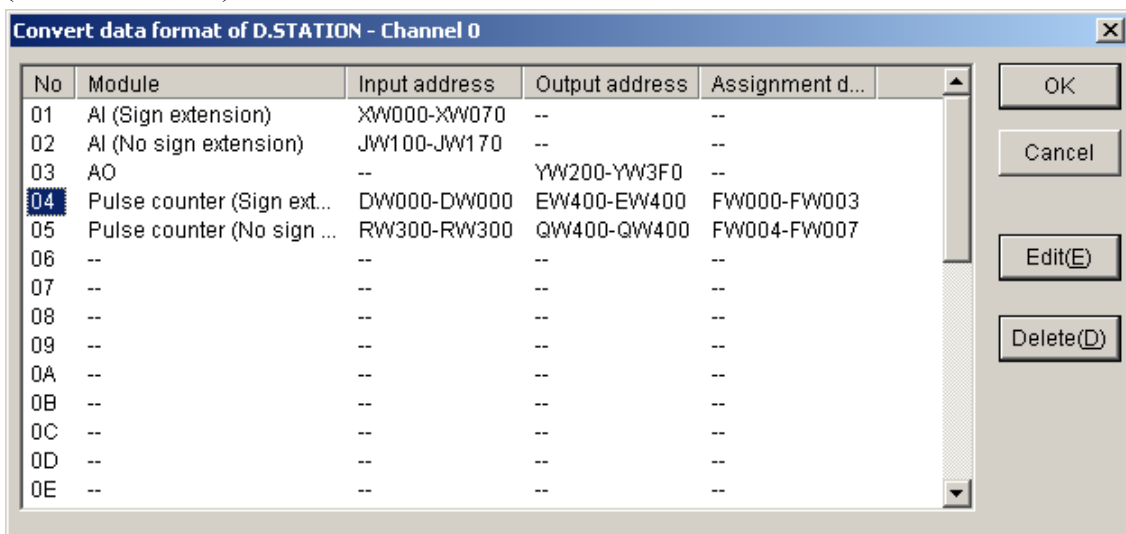

Figure 4-36 The [Convert data format of D.STATION] Window

(For the S10V)

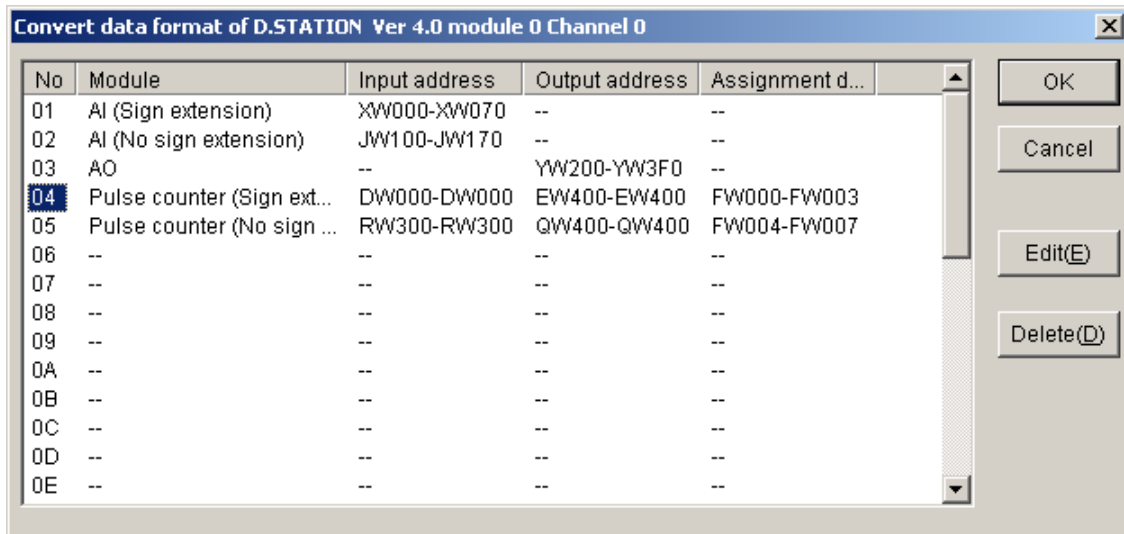

Figure 4-37 The [Convert data format of D.STATION] Window

When it opens, choose the desired number in the “No.” column and click the **Edit** button. Selectable numbers are in the range 1 to 20 (hexadecimal) and up to 32 modules can be registered under arbitrarily selected numbers.

- ③ The [Setup data format conversion of D.STATION] window as shown below opens.

(For the S10mini)

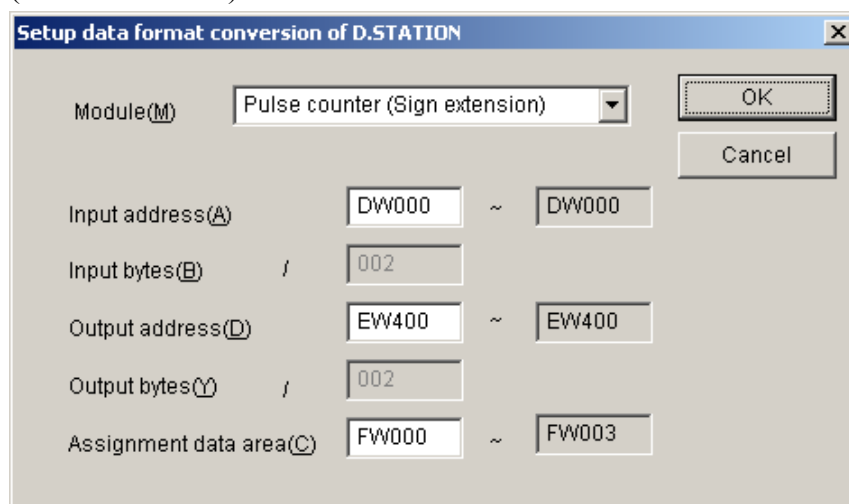

Figure 4-38 The [Setup data format conversion of D.STATION] Window

(For the S10V)

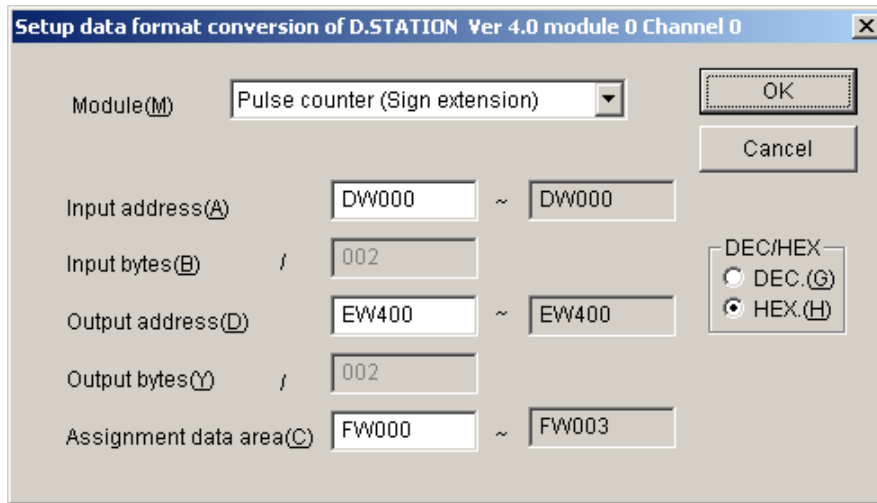

Figure 4-39 The [Setup data format conversion of D.STATION] Window

From the above [Setup data format conversion of D.STATION] window, set format conversion for one PI/O module at a time. Of the above setting items, the input and output byte counts can be displayed in either decimal or hexadecimal notation by selecting the desired radio button in the DEC/HEX box, and can be entered in the selected notation. By default, they are displayed in hexadecimal.

● Module

Allows you to select a type of I/O module for which to perform data format conversion. The D.NET module will convert data format according to this selection.

Selectable options	Unused AI (with sign extension) AI (without sign extension) AO Pulse counter (with sign extension) Pulse counter (without sign extension)
--------------------	--

- Input/output address

Is specified to indicate the desired location in the range of input/output addresses that has been set via the [Parameter edit] window shown under “4.5.2 Setup station parameters.” The specified address will be used as the starting address of format conversion. It must be within the input/output area that has been set by the input address pair and input byte count, or by the output address pair and output byte count, via the [Parameter edit] window shown under “4.5.2 Setup station parameters.”

Setting range	XW000 – XWFF0 YW000 – YWFF0 RW000 – RWFF0 MW000 – MWFF0 GW000 – GWFF0 EW400 – EWFF0 FW000 – FWBFF DW000 – DWFFF JW000 – JWFF0 QW000 – QWFF0 /100000 – /4FFFFE(extension memory) (*1) LBW0000 – LBWFFF0 (*2) LWW0000 – LWWFFFF (*2) LXW000 – LXW3FFF (*2)
---------------	---

(\*1) In the S10V, this setting is not allowed.

(\*2) In the S10mini, this setting is not allowed.

- Input/output byte count

Is specified in the range shown below to fix how many data bytes to be subjected to format conversion.

Format conversion will be performed on the input/output bytes specified here, starting from the specified input/output address. With the S10V, you can enter the input/output byte count in decimal. (With the S10mini, you can enter this parameter only in hexadecimal.)

Module type	Setting range (unit: byte)
AI or AO (both with or without sign extension)	1 to /40 (in hexadecimal) 1 to 64 (in decimal)
Pulse counter	Always 2 (this setting cannot be changed by users)

### **NOTICE**

- The input/output area set by both an input/output address and an input/output byte count for format conversion must be within the range of the input/output area that has been set by both the input/output address pair and input/output byte count entered via the [Parameter edit] window for station parameter setting. If an attempt is made to set the former input/output area beyond the limits of the latter, the tool will report it as an out-of-range error and will not write the specified parameters to the D.NET module. In this case, you have to correct the parameters and retry writing.
- A total of 32 cases of format conversion can be registered, but the number of cases that can be registered per D.Station is limited to 8. If an attempt is made to register more than eight cases per D.Station, the tool will report it as a “too many cases for registration” error and will not write the specified parameters to the D.NET module. In this case, you have to correct the parameters and retry writing.
- If a specified module type is AI or AO (with or without a sign extension) and a specified input/output byte count is an odd number, then the count will be rounded up to the nearest even number, as exemplified below.  
Examples: If a byte count of 1 is specified, it is rounded up to 2.  
If a byte count of 3 is specified, it is rounded up to 4.

- **Assignment data area**

The assignment data area is the LPU module’s internal I/O area to which the pulse count data split into two words is assigned. (This memory area has a size of four words: two words used as write count data and two words used as read count data. For more information, see “4.5.3 D.Station data format conversion.”) By storing write count data and control data in this area’s first and second words, respectively, you can control the pulse counter module. Its third and fourth words are used to store read count data and status codes, respectively. These last two words can be used when reading the current count value from the pulse counter module. This memory area does not serve as a user interface for reading from or writing to the input/output address.

<Example of setting parameters>

Given the configuration shown in Figure 4-40, you could convert the data formats of the AI modules (slot Nos. 0 through 3) and pulse counter module (slot No.7) mounted in the D.Station by setting parameters as shown below.

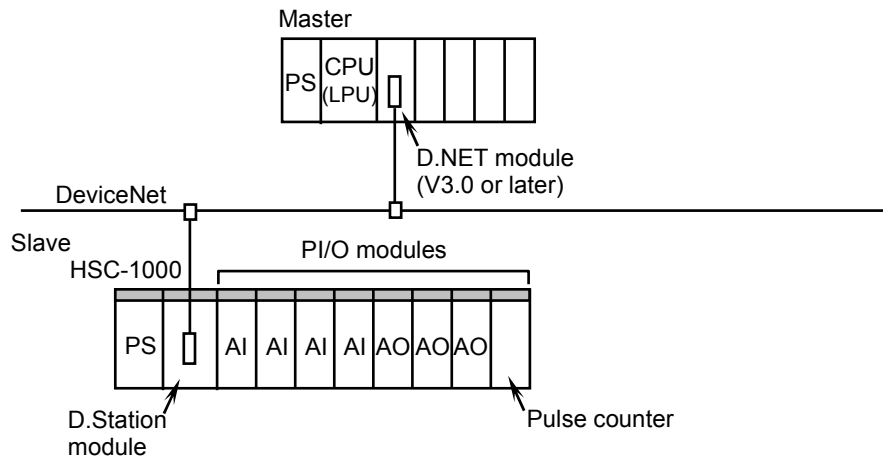

Figure 4-40 A Configuration Using D.Station Data Format Conversion

(1) D.Station module settings

Switch name	Set value	Meaning/Effect of set value
NA	Any value can be set in the range /0 to /3F, but it must not be identical to the D.NET module's.	MAC ID of the D.Station module
SLOT	2	64 points set, ordinary transfer mode selected
FUNC1	0 to 2 (a value that must be set in accordance with the baud rate to be used)	No module information prepared
FUNC2	0	Byte swap, RESET, FREE



## 4 OPERATION

### (2) D.NET module settings

The following settings are made to use an input area of XW800 onward, an output area of YW800 onward, and an assignment data area of FW000 onward for the pulse counter.

#### <Station parameter settings>

Select byte reversal mode on the D.NET side because byte swap is selected on the D.Station side.

Set these items to /40 (hex) because the input and output byte counts of the D.Station are both 64 (determined from “64 points × 8 slots = 64 bytes”).

#### <D.Station data format conversion settings>

No	Module	Input address	Output address	Assignment d...
01	AI (Sign extension)	XW800-XW8F0	--	--
02	Pulse counter (Sign ext...)	XW9C0-XW9C0	YW9C0-YW9C0	FW000-FW003
03	--	--	--	--
04	--	--	--	--
05	--	--	--	--
06	--	--	--	--
07	--	--	--	--
08	--	--	--	--
09	--	--	--	--
0A	--	--	--	--
0B	--	--	--	--
0C	--	--	--	--
0D	--	--	--	--
0E	--	--	--	--

<AI settings>

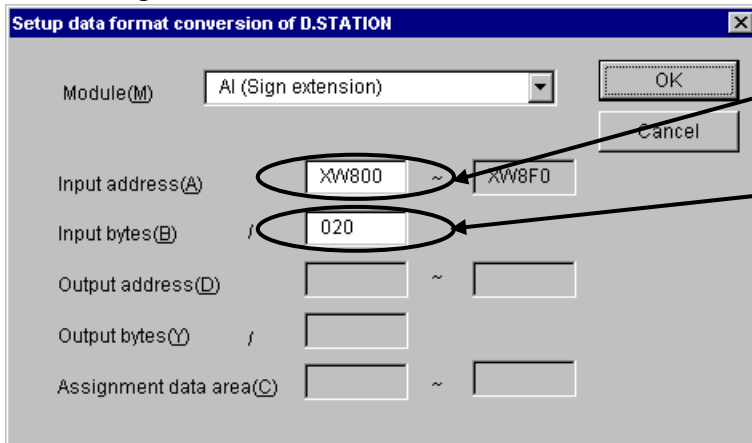

Starting address of slot 0.

Set this item to /20 (hex) because 4 words (64 points set) × 4 slots (slots 0 thru 3) = 32 bytes.

<Pulse counter settings>

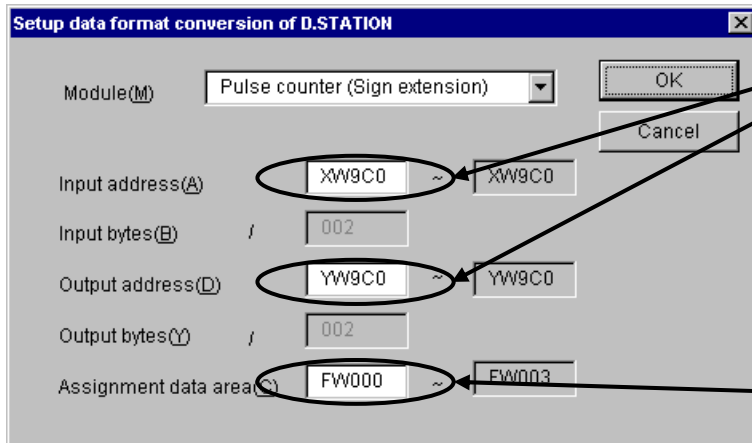

Starting address of slot 7.

Starting address of the assignment data area for the pulse counter.

## 4.6 Setting Slave Parameters

### 4.6.1 Procedure for setting slave parameters

You can change parameter values for slave devices that are connected to a D.NET module installed in the S10V controller unit and used as the master (i.e., the D.NET module is running in master mode). If you want to accomplish this, perform the steps [1] through [4] below, in that order. Otherwise, skip this entire section. The distinction between station parameters and slave device parameters is described on the next page.

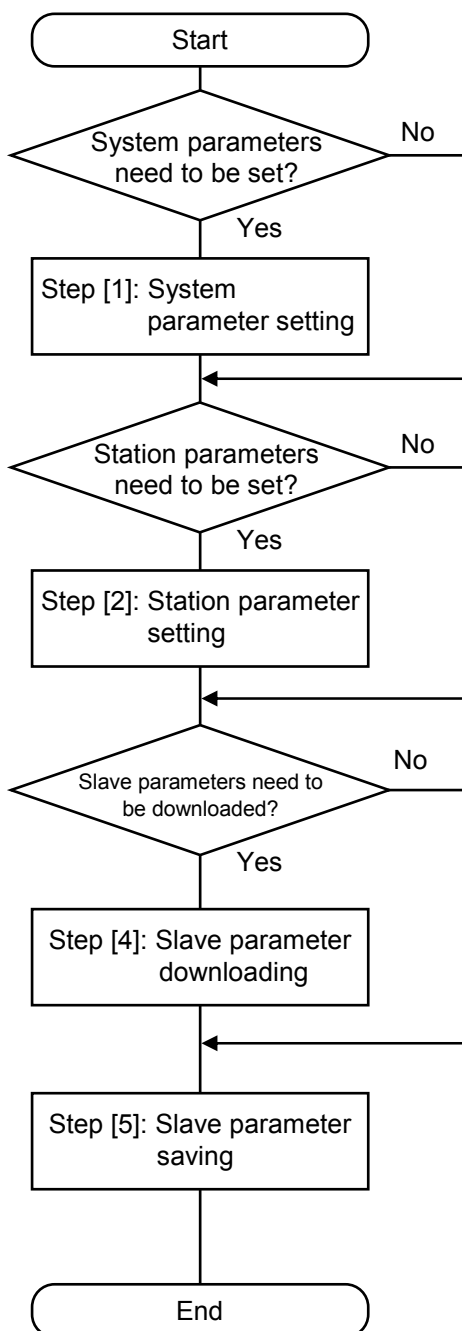

#### Step [1]: System parameter setting

Set the D.NET module's operation mode to "Master/Peer". For more information on the system parameter setting, see "4.5.1 System parameter setting."

#### Step [2]: Station parameter setting

Set all necessary station parameters for a slave device that is connected to the D.NET module. For example, set the communication type to either "Poll" or "Bit strobe reception". If the slave device is provided with no station parameters, skip this step. For more information on the station parameter setting, see "4.5.2 Station parameter setting."

#### Step [3]: Slave parameter editing

Edit slave parameters for the slave device if necessary. Editing slave parameters requires an EDS (electronic data sheet) file for the slave device. Obtain the EDS file from the slave-device manufacturer. For more information on the slave parameter setting, see "4.6.2 Slave parameter setting."

#### Step [4]: Slave parameter downloading

Download the slave parameters you have edited in Step [3] to the slave device. To accomplish this, you first have to terminate the I/O communication in progress. For more information on the slave parameter downloading, see "4.6.4 Operating the [Setup slave parameters] window."

#### Step [5]: Slave parameter saving

Save the slave parameters you have edited in Step [3] into a file in text format. If you have not edited any slave parameters in Step [3], skip this step. For more information on the slave parameter saving, see "4.6.4 Operating the [Setup slave parameters] window."

The following information would be helpful when you distinguish between station parameters and slave parameters.

**Station parameters:** Parameters that are essential for data communication between the D.NET module and slave devices connected to it. These parameters, as well as system parameters, must be set in cases where the D.NET module needs to be used for data communication in master-peer mode.

**Slave parameters:** Parameters that are specific to a particular slave device. These parameters have their values set inside the slave device.

<D.NET modules' Ver-Rev numbers supporting slave parameter setting>

Slave parameter setting is supported only by the D.NET system's Ver-Rev numbers 01-03 or later and by the following Ver-Rev numbers of the D.NET module:

Module name	Module model	Supporting Ver-Rev numbers
D.NET module	LQE570/575	0004-0004 or later
2-channel D.NET module	LQE770/775	0001-0002 or later

**Note:** The parameter values specified in the obtained EDS file have the corresponding parameter values set inside the slave device. These corresponding parameter values can be called up from the [Setup slave parameters] window. In addition, they can also be updated with new parameter values for the slave device, except for the values of read-only parameters. Reading from the EDS file is not supported in master-slave I/O communication setting. To achieve master-slave I/O communication setting, use the [Setup station parameters] window (shown under "4.5.2 Station parameter setting"), in place of the [Setup slave parameters] window.

## 4 OPERATION

### 4.6.2 Slave parameter setting

You can set parameters for a slave device that is connected to the master D.NET module, and can also display the set parameters on screen, all by performing the procedure described below.

First, click on the **Setup slave parameters** button in the D.NET system's basic window as shown below. The [Setup slave parameters] window will then appear.

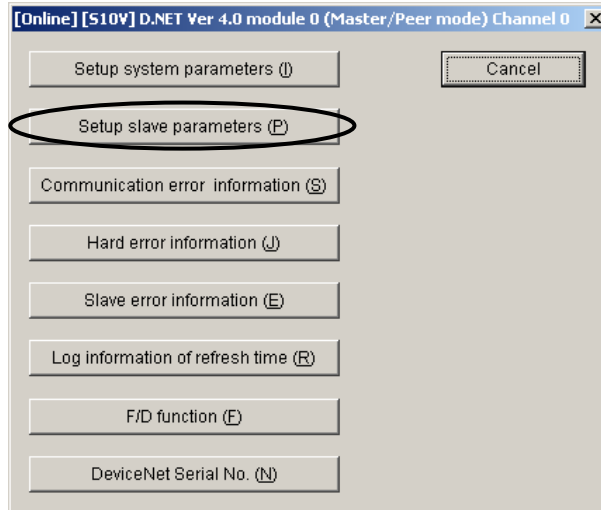

Figure 4-41 The D.NET System's Basic Window Displayed in Online Mode

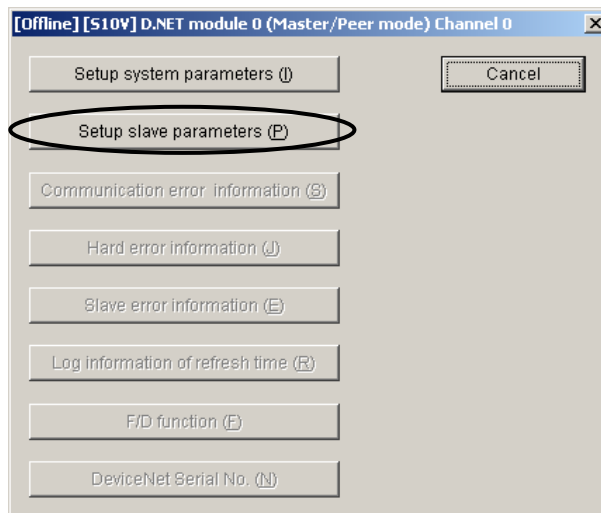
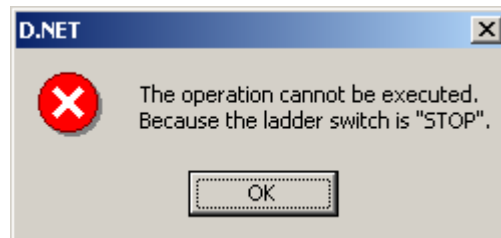

Figure 4-42 The D.NET System's Basic Window Displayed in Offline Mode

However, if the D.NET module running in online mode has already stopped data communication at the time you click the **Setup slave parameters** button, then the error message shown below will appear, and the [Setup slave parameters] window will not. For information on why data communication has already been stopped, see “● PCs OK signal linkage setting” under “4.5.1 System parameter setting.”



As shown below, the [Setup slave parameters] window displayed presents the following information: the MAC IDs for slave devices, the file names of existing EDS files, user-specified arbitrary names, and the device names, connection statuses, and slave existence/nonexistence definitions of those slave devices.

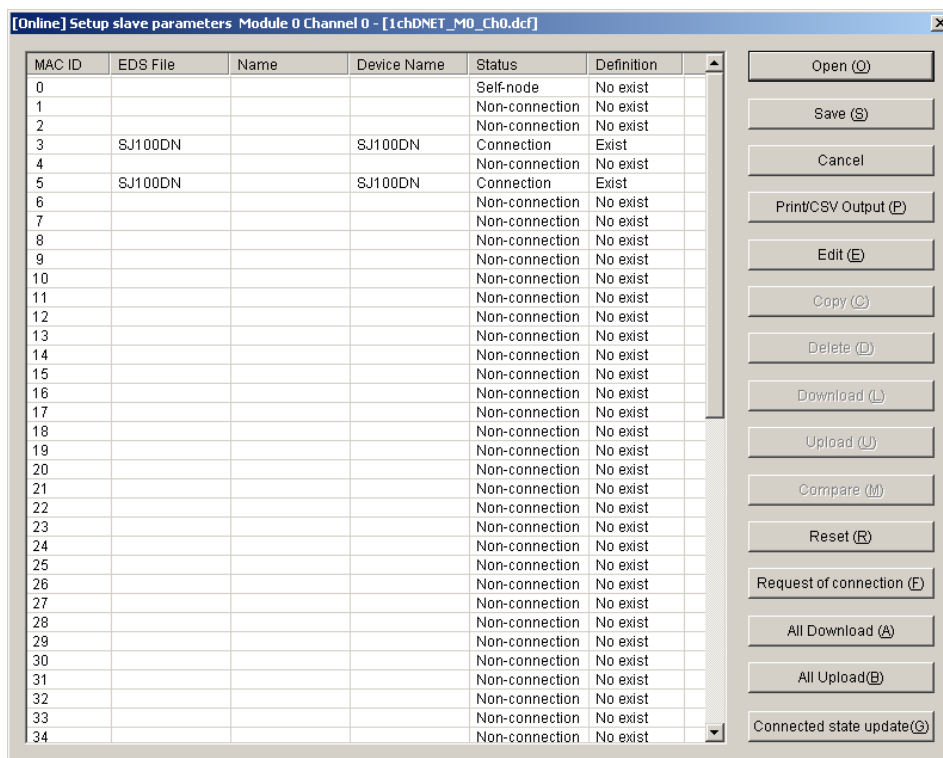

Figure 4-43 The [Setup slave parameters] Window (Displayed in Online Mode)

## 4 OPERATION

---

By default, this [Setup slave parameters] window presents the contents of the last slave parameter setting file that has been requested from among those that were previously specified in  and  requests. The currently displayed slave parameter setting file's file name is shown in the window's title.

If there is any difference detected between the D.NET module information in the slave parameter setting file and the D.NET module information that has been selected in the module/channel selection window (or dialog box), a warning message dialog box as shown below will appear before the [Setup slave parameters] window.

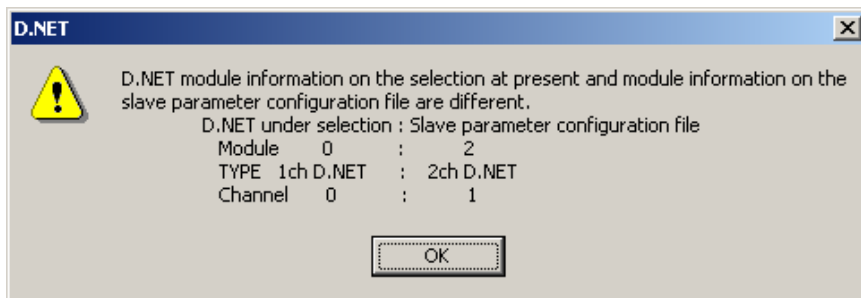

Figure 4-44 A Warning Message Dialog Box Displayed When All of the Module No., D.NET Type, and Channel No. Are Found Different between the Two

In this case, click the  button in the dialog box. If you want to add a change to the slave parameter setting file, click the  button in the [Setup slave parameters] window and choose another slave parameter setting file. For details, see “(1) Opening a file” under “4.6.4 Operating the [Setup slave parameters] window.”

### 4.6.3 Items displayed in the [Setup slave parameters] window

The following are the items of information displayed in the [Setup slave parameters] window.

- MAC ID

The “MAC ID” column of the window shows all available MAC IDs for slave devices with decimal integers in the range 0 to 63.

- EDS File

The “EDS File” column of the window shows the file name(s) of an EDS file(s) for the existing slave device(s). Choose the desired EDS file, and then you can set new values for the slave parameters. The EDS file, when displayed, reveals a string(s) of characters in the “[File] DescText” column unless the column is empty. If it is empty, the “[File] DescText” column shows nothing.

- Name

The “Name” column of the window shows the user-specified ID name(s) of the existing slave device(s).

- Device Name

The “Device Name” column of the window lists the device name(s) defined in the EDS file(s).

- Status

The “Status” column of the window shows whether the existing slave device(s) are currently connected to the network (they are in “Connection” state) or not (they are in “Non-connection” state). The “Connection” indication appears when the D.NET module has recognized an existing slave device on the DeviceNet network. In order for the D.NET module to recognize an existing slave device on the network, you have to set the communication type to either “Poll” or “Bit Strobe reception” through station parameter setting.

The “Self-node” indication appears when the D.NET module with a given MAC ID (0 to 3F) is running in online mode.

- Definition

The “Definition” column of the window indicates whether a communication type definition of “Poll” or “Bit Strobe reception” is given for an existing slave device through station parameter setting. If such a definition is given, an “Exist” indication appears for the slave device.

Otherwise, a “No exist” indication appears for it.



## 4 OPERATION

### 4.6.4 Operating the [Setup slave parameters] window

This subsection contains step-by-step instructions for using each operation button provided in the [Setup slave parameters] window. Of these operation buttons, the seven consecutive buttons **Download** through **All Upload** (see Figure 4-23) are provided exclusively for maintenance operations on slave devices, and they are not usable until any I/O communication in progress is stopped. If you first click any of those buttons during I/O communication in progress, the confirmation message shown below appears. In this case, stop the I/O communication in progress and then click the **OK** button if you really want to carry out maintenance on the slave device.

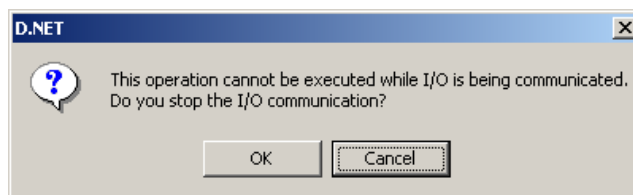

Figure 4-45 A Confirmation Message to Confirm You Want to Stop I/O Communication

In offline mode, the D.NET system does not allow you to perform any operation on any slave device. This condition is reflected by the operation buttons **Download** through **Connected state update** that are all grayed out.

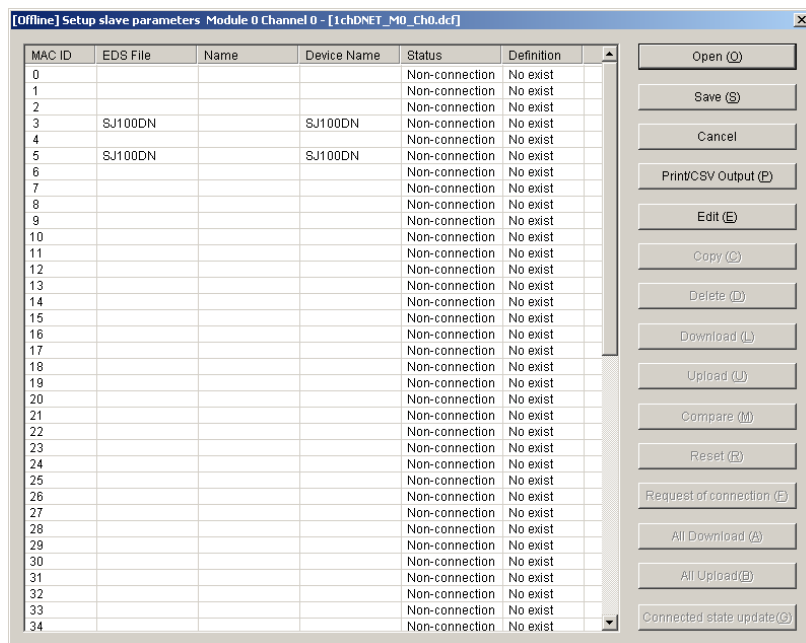

Figure 4-46 The [Setup slave parameters] Window Displayed in Offline Mode

## (1) Opening a file

When you click the **Open** button in the [Setup slave parameters] window, the slave parameter setting file selection window as shown below appears. In this window, choose the desired slave parameter setting file and click the **Open** button to open the selected file.

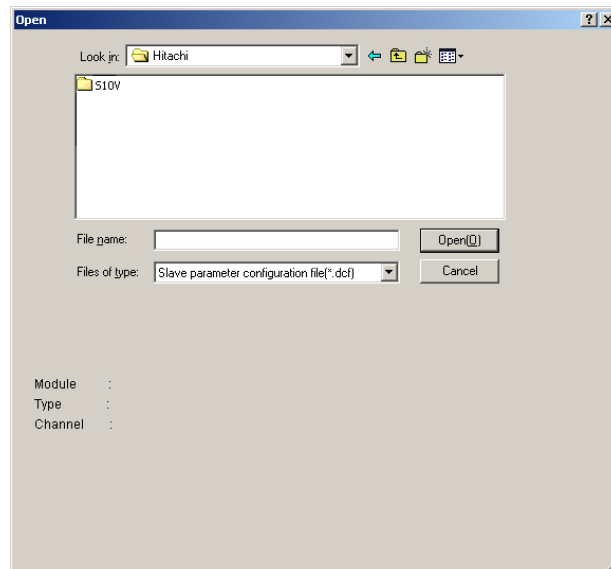

Figure 4-47 The Slave Parameter Setting File Selection Window

## &lt;Creating a slave parameter setting file&gt;

You can create a new slave parameter setting file from the [Open] window. Simply enter a unique file name directly into the “File name” edit box in the [Open] window and click the **Open** button. The confirmation message shown below appears to confirm that you really want to create a new slave parameter setting file.

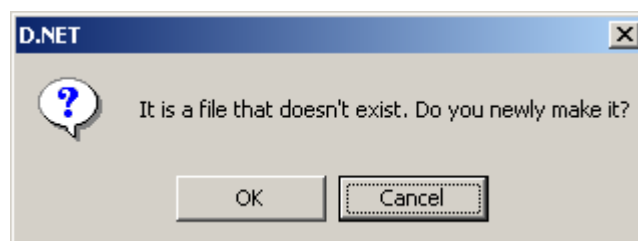

Figure 4-48 A Confirmation Message to Confirm You Want to Create a Slave Parameter Setting File

<A warning message displayed in reading an existing slave parameter setting file>

If there is any difference detected between the D.NET module information in the slave parameter setting file being read-accessed and the D.NET module information that has been selected in the module/channel selection window (or dialog box), a warning message dialog box as shown below is presented before the [Setup slave parameters] window. The D.NET module information presented in the warning message is only the item(s) found different in the entire D.NET module information, which consists of the module No., D.NET type, and channel No.

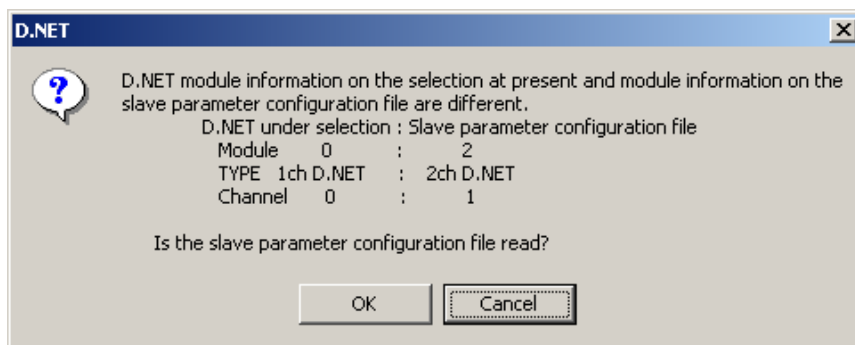

Figure 4-49 A Warning Message Dialog Box Displayed When All of the Module No., D.NET Type, and Channel No. Are Found Different between the Two

In the above dialog box, click one of the following:

- OK** : Clicking this button read-accesses the slave parameter setting file and displays its contents in the [Setup slave parameters] window. The file name of the slave parameter setting file accessed is shown as part of the title of that window.
- Cancel** : Clicking this button quits processing without read-accessing the slave parameter setting file.

## (2) Saving as named

When you click the **Save** button in the [Setup slave parameters] window, the [Save As] window as shown below appears.

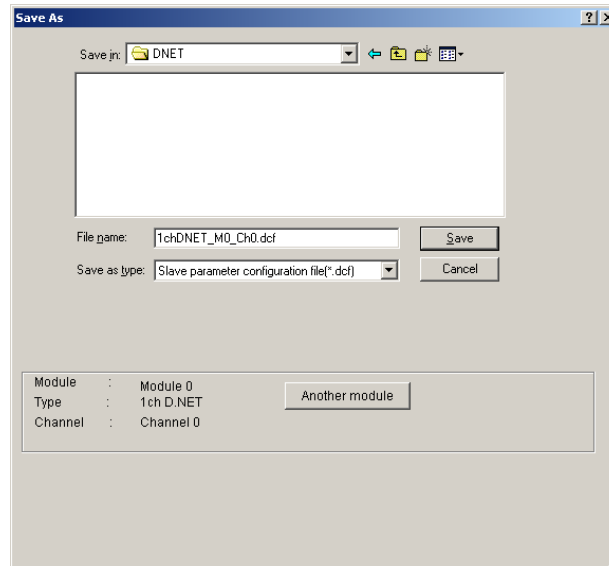

Figure 4-50 The [Save As] Window

In this window, specify a unique file name (if necessary) and click the **Save** button. Then, the result of your editing will be saved into the named (or current) file and the [Setup slave parameters] window will become active again.

If you click the **Cancel** button instead of the **Save** button in the [Save As] window, the [Setup slave parameters] window will then become active again, with no saving performed.

### <Changing the current module to another>

You can change the current D.NET module to another D.NET module and then save the result of your editing for the latter. To accomplish this, click the **Another module** button in the [Save As] window. The [For another module] window as shown below will then appear. Select the desired D.NET module.

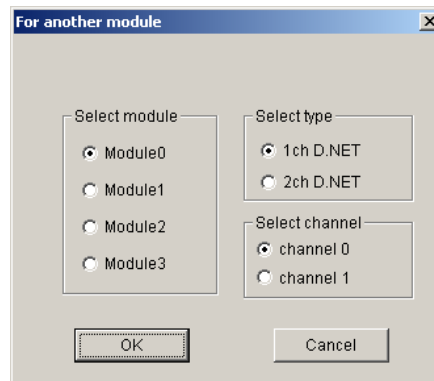

Figure 4-51 The [For another module] Window

The following is a list of the options listed in the [For another module] window and their descriptions.

- Select module

The “Select module” pane allows you to choose one of the D.NET modules numbered 0 through 3.

- Select type

The “Select type” pane allows you to specify that the selected D.NET module is a 1-channel D.NET module or a 2-channel D.NET module.

- Select channel

The “Select channel” pane is used only when the selected module type is 2-channel D.NET (“2ch D.NET”). In this pane, choose either channel 0 or channel 1 of the 2-channel D.NET module.

The slave parameter setting file saved as described above will be read-accessed by default if the module No. and channel No. selected in the [For another module] window is selected the next time in the module/channel selection window. The [Setup slave parameters] window will open following that read-access.

### (3) Canceling

When you click the **Cancel** button in the [Setup slave parameters] window, a confirmation dialog box as shown below appears to confirm whether or not you are saving the slave parameter setting file. This **Cancel** button is used when, for instance, you need not save the file after you have edited the slave parameters or uploaded them to all existing (but non-connected) slaves at once.



Figure 4-52 A Confirmation Dialog to Confirm Whether or Not You Are Saving the Slave Parameter Setting File

In the above dialog box, click one of the following:

**OK** : Clicking this button opens the [Save As] window. Save the slave parameter setting file you have edited. When the saving is completed, I/O communication starts and the [Setup slave parameters] window closes simultaneously.

**Cancel** : Clicking this button immediately starts I/O communication without saving the slave parameter setting file you have edited. The [Setup slave parameters] window closes simultaneously.

Clicking the  button may present a confirmation dialog box as shown below to confirm whether or not you want to start I/O communication. This is the case when I/O communication is in a stopped state and you have neither edited the slave parameters nor uploaded them to all existing (but non-connected) slaves at once.

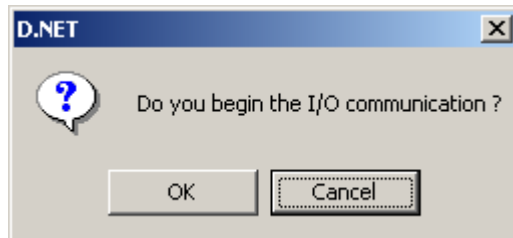

Figure 4-53 A Confirmation Dialog to Confirm Whether or Not You Want to Start I/O Communication

If you click the  button in the above confirmation dialog box, this causes the [Setup slave parameters] window to close and the I/O communication to start. If you click the  button in place of OK, this causes the [Setup slave parameters] window to become active again with I/O communication remaining in a stopped state.

## (4) Printing or outputting in CSV format

When you click the **Print/CSV Output** button in the [Setup slave parameters] window, the following [Print/CSV Output] window appears:

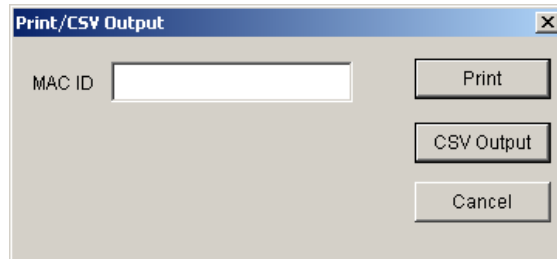

Figure 4-54 The [Print/CSV Output] Window

In this window:

- MAC ID

The “MAC ID” edit box allows you to enter a decimal integer(s) in the range 0 to 63 as the MAC ID(s) of a desired slave device(s). If you want to specify two or more MAC IDs at a time, separate them from each other with a comma(s) or connect the first and last of them with a hyphen to specify the range of MAC IDs. For example, the following is an example of a specification of three MAC IDs separated from each other with commas:  
0,5,20

and the following is an example of a specification of a range of MAC IDs: 1-40

If any decimal integer entered is found to be out of range, the following dialog box will appear:



Figure 4-55 The MAC ID Error Message Dialog Box



If the slave device identified by a specified MAC ID has no slave parameters defined in it, the Print/CSV Output process will skip the slave device and continue processing with the next specified MAC ID. However, if there are no slave devices having slave parameters defined in them, the Print/CSV Output process will display the following dialog box:

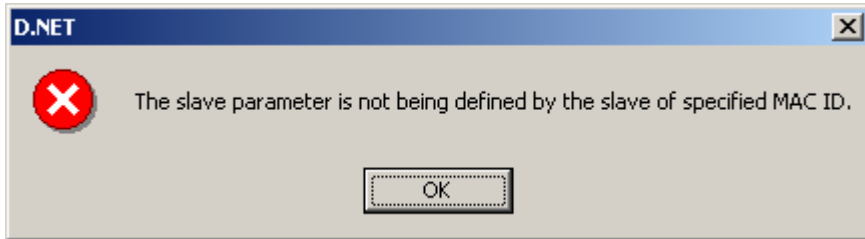

Figure 4-56 The “Slave Parameters Undefined” Error Message Dialog Box

When you have entered the desired MAC ID(s) into the edit box, click either the **Print** button or the **CSV Output** button. If you click the **Print** button, the [Print] dialog box as shown below opens. Specify the desired printer and set its properties if necessary. Then, click the **OK** button. Printing will start.

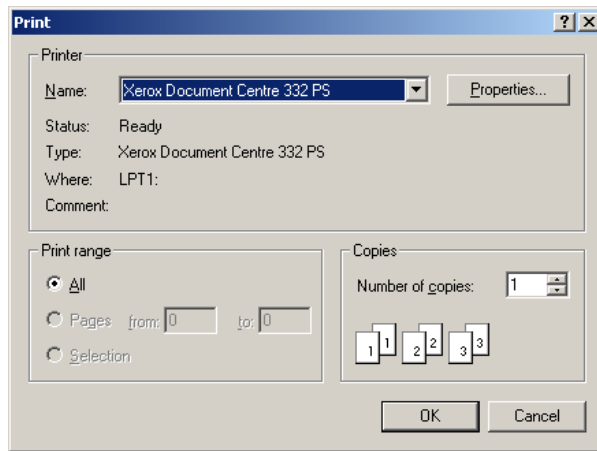

Figure 4-57 The [Print] Dialog Box

If you click the **CSV Output** button instead of [Print], the [Save As] dialog box as shown below appears. Select the desired output folder and specify a unique file name. Then, click the **Save** button. Outputting will start.

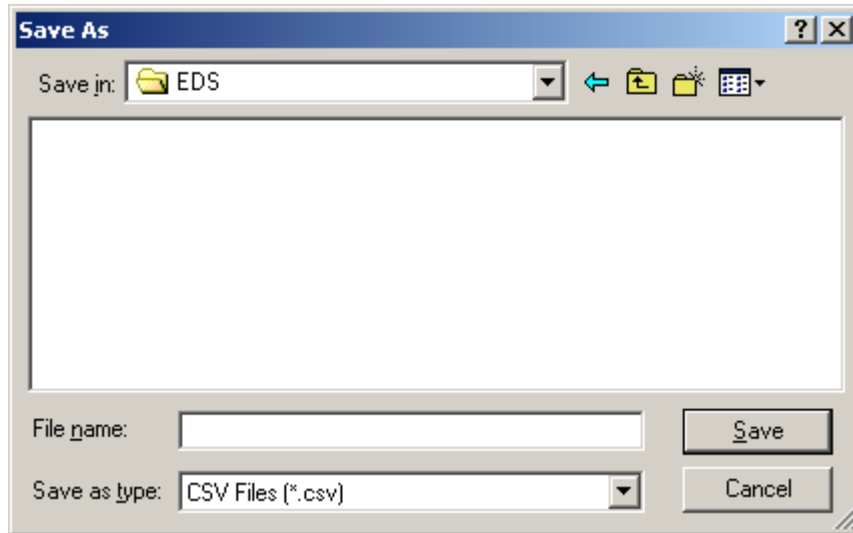

Figure 4-58 The [Save As] Dialog Box

## 4 OPERATION

### (5) Editing

When you select the MAC ID of a desired slave device in the [Setup slave parameters] window and then click the **Edit** button in the same window, the [Edit slave parameters] window as shown below appears. To edit the slave parameters of the specified slave device, select the EDS file and then set new parameter values for the classes, instances, and attributes displayed for each parameter group.

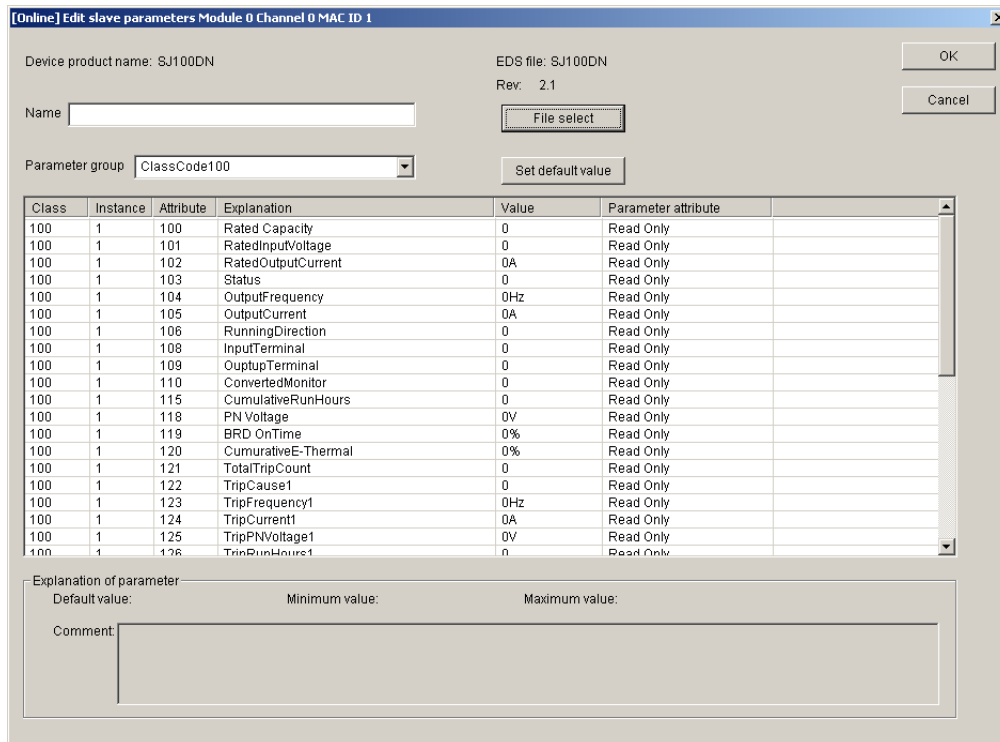

Figure 4-59 The [Edit slave parameters] Window

The following is a list of the items displayed in the [Edit slave parameters] window and their descriptions.

- Device product name

The device product name identifies the model of the slave device.

- EDS file

The EDS file provided for the slave device is identified by its EDS file name, which is the character string set as “[File] DescText” in that EDS file.

- Rev

This item is the revision number of the EDS file.

- Name  
The name is the user-specified name for the slave device. You can enter a string of up to 32 characters as this name.
- File select  
The  button is clicked to select an EDS file.
- Parameter group  
The parameter group is a group of parameters that can be set for the slave device. Specify a parameter group you want to edit in the edit box. No parameters other than those of the specified parameter group are listed in the displayed list.
- Set default value  
The  button is clicked to display the default parameter values defined in the EDS file. All the parameter values relating to the specified slave device are the default parameter values defined in the EDS file.
- Value  
Any value listed in the displayed list in correspondence with a class, instance, and an attribute can be double-clicked to enter a new value, provided the parameter allows editing. Double-clicking any non-editable parameter value does not place the D.NET system into input mode.
- OK  
The  button is clicked to close the [Edit slave parameters] window without discarding the result of your editing.
- Cancel  
The  button is clicked to close the [Edit slave parameters] window while discarding the result of your editing.
- Explanation of parameter  
The “Explanation of parameter” shows the default parameter value, minimum value, maximum value, and comment for a selected class, instance, and attribute.

Note: Clicking the  button in the [Setup slave parameters] window displays the [Save As] dialog box. Save the result of your editing in the desired slave parameter setting file.

## 4 OPERATION

---

### (6) Copying

When you select the MAC ID of a desired slave device in the [Setup slave parameters] window and then click the **Copy** button in the same window, the [Copy of slave parameters] window as shown below appears. To copy the slave parameters of the desired slave device (source) to the desired destination, enter the MAC ID of the destination and click the **OK** button. The slave parameters of the source will then be copied to the destination.

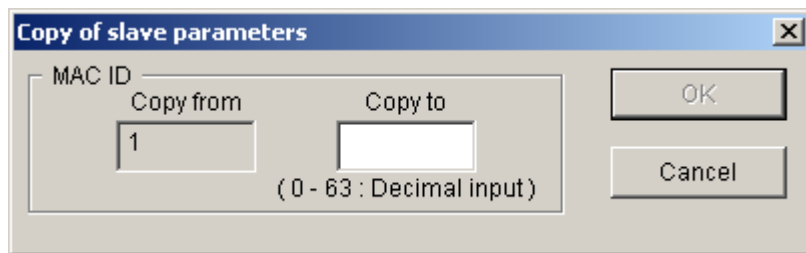

Figure 4-60 The [Copy of slave parameters] Window

In this window:

- MAC ID

The “MAC ID” edit box allows you to enter a decimal integer in the range 0 to 63 as the MAC ID of the destination.

If the specified MAC ID of the destination is already defined with information for another EDS file, a confirmation dialog box as shown below appears to confirm whether or not you are overwriting the slave parameters with new parameter values. Clicking the **OK** button overwrites them.

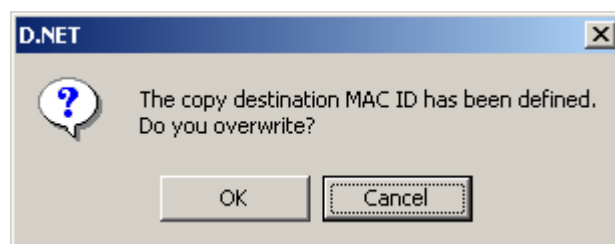

Figure 4-61 A Confirmation Dialog to Confirm Whether or Not You Are Overwriting the Slave Parameters with New Values

## (7) Deleting

When you select the MAC ID of a desired slave device in the [Setup slave parameters] window and then click the **Delete** button in the same window, a confirmation dialog box as shown below appears. The purpose of this confirmation is to confirm whether or not you are deleting the slave parameters of the desired slave device. Click the **OK** button. The slave parameters will then be deleted.

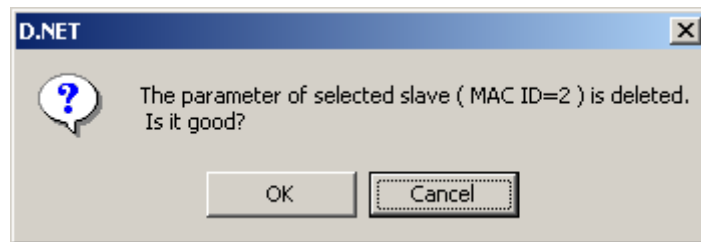

Figure 4-62 A Confirmation Dialog to Confirm Whether or Not You Are Deleting the Slave Parameters

## (8) Downloading to slave

When you select the MAC ID of a desired slave device in the [Setup slave parameters] window and then click the **Download** button in the same window, a confirmation dialog box as shown below appears. The purpose of this confirmation is to confirm whether or not you are downloading the slave parameters to the desired slave device. Click the **OK** button. The slave parameters will then be downloaded.

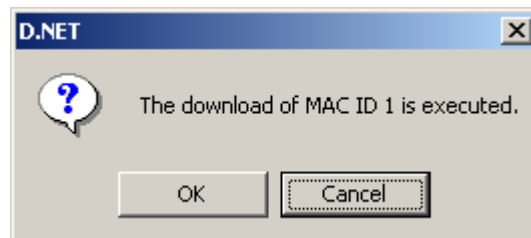

Figure 4-63 A Confirmation Dialog to Confirm Whether or Not You Are Downloading the Slave Parameters

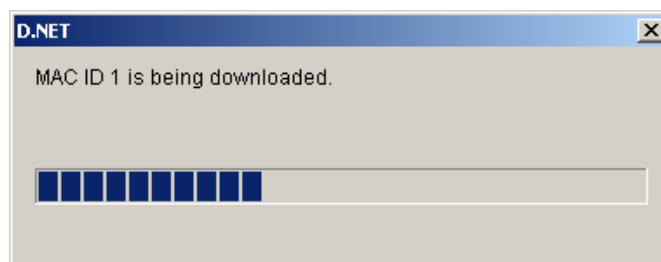

Figure 4-64 The Download Progress Window



Figure 4-65 The End-of-Download Window

If the downloading in progress fails due to an error, the following download failure message dialog box appears.

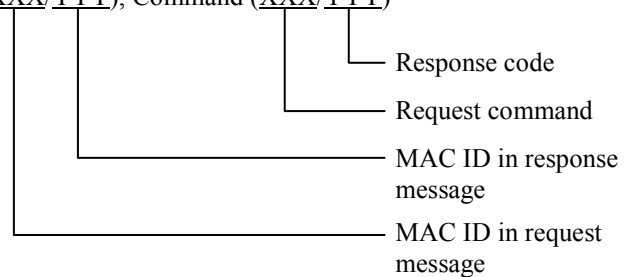

Figure 4-66 The Download Failure Message

In the above message, XXXXXXXX is a brief description of the error, which is listed in the table below.

No.	Brief description of error	Cause	Remedial action by user
1	(Timeout error)	The D.NET module may be in failure.	Try again. If the same error recurs, replace the D.NET module with a new one.
2	(Slave response timed out)	The slave did not send back a response to an issued request within the timeout monitoring time. The slave device may be in failure.	Try again. If the same error recurs, replace the slave device with a new one.
3	(Communication line error)	The tool (D.NET system) and the D.NET module are not physically connected together.	Check the physical connection between the two, including the connecting cable.
4	(Slave response error: Class=XXX, Instance=XXX, Attribute=XXXX, MAC ID (XXX/YYY), Command (XXX/YYY)) (*1)	The slave device sent back a response error.	Try again. If the same error recurs, contact the slave-device manufacturer for technical support.
5	(Slave response data size error: Class=XXX, Instance=XXX, Attribute=XXXX, Data size (XXX/YYY)) (*2)	A parameter whose data type is not matching between the EDS file and the corresponding slave device was detected.	Review the contents of the EDS file.

(\*1) Class=XXX, Instance=XXX, Attribute=XXXX, MAC ID (XXX/YYY), Command (XXX/YYY)



(\*2) Class=XXX, Instance=XXX, Attribute=XXXX, Data size (XXX/YYY)

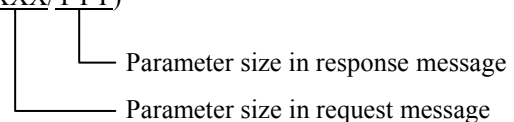

Error type No. 2 above is detected by the D.NET module and all other error types are detected by the tool (D.NET system).



(9) Uploading from slave

When you select the MAC ID of a desired slave device in the [Setup slave parameters] window and then click the  button in the same window, a confirmation dialog box as shown below appears. The purpose of this confirmation is to confirm whether or not you are uploading the slave parameters from the desired slave device. Click the  button. The slave parameters will then be uploaded.

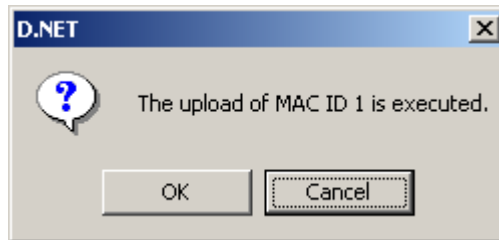

Figure 4-67 A Confirmation Dialog to Confirm Whether or Not You Are Uploading the Slave Parameters

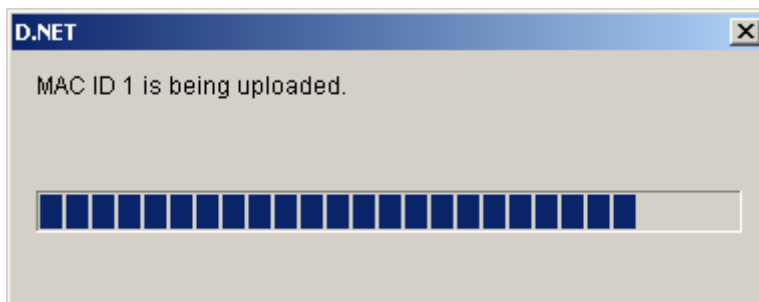

Figure 4-68 The Upload Progress Window



Figure 4-69 The End-of-Upload Window

## (10) Comparing parameters

When you select the MAC ID of a desired slave device in the [Setup slave parameters] window and then click the **Compare** button in the same window, a confirmation dialog box as shown below appears. The purpose of this confirmation is to confirm whether or not you are comparing the result of your editing being displayed in the [Setup slave parameters] window with the parameter values set in the desired slave device. Click the **OK** button. The result of your editing will then be compared with the set parameter values. If any difference is found by the comparison, the slave parameter containing the difference will be displayed.

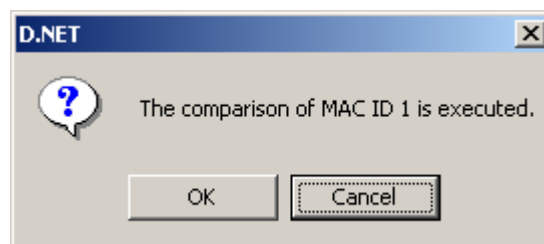

Figure 4-70 A Confirmation Dialog to Confirm Whether or Not You Are Comparing the Result of Your Editing with the Set Parameter Values

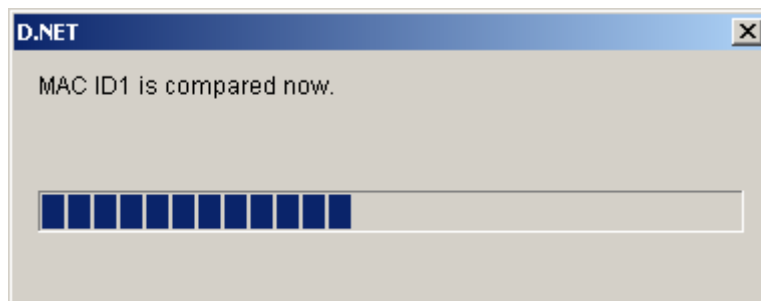

Figure 4-71 The Comparison Progress Window

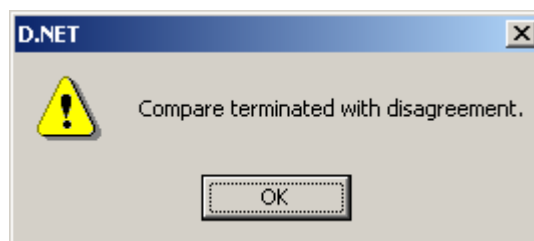

Figure 4-72 The End-of-Comparison-with-Difference-Found Message

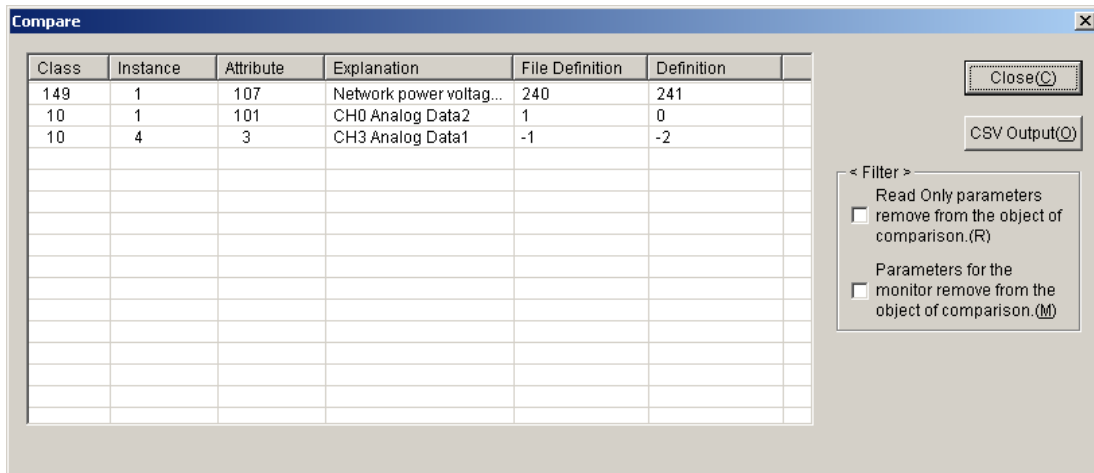

Figure 4-73 The [Compare] Window

The following is a list of the items displayed in the [Compare] window and their descriptions.

- Class, Instance, and Attribute

Explanations for each combination of a class, instance, and an attribute are those from the EDS file. For details on these explanations, refer to the slave device manual.

- File Definition

Each value in the “File Definition” column is the value of the slave parameter that is identified by a particular class, instance, and attribute and that is present in the result of your editing.

- Definition

Each value in the “Definition” column is the value of the slave parameter that is identified as a particular class, instance, and attribute and that is set in the slave device.

- Filter

One of the two filters listed -- one for removing all read-only parameters from the object of comparison and one for removing all monitoring parameters from the object of comparison -- can be applied to the result of the comparison. Whether a particular slave parameter is provided for read-only use or monitoring use can be determined from the attribute set for the slave parameter in the EDS file.

Note: Parameter values not listed in the displayed list within the [Edit slave parameters] window may be output as differences by the comparison process described above.

This is because the comparison process covers all the slave parameters, including those not belonging to any parameter group.

## (11) Resetting slave

When you select the MAC ID of a desired slave device in the [Setup slave parameters] window and then click the **Reset** button in the same window, the [Slave reset] window as shown below appears. To reset the desired slave device, enter both a class value and an instance value for the slave device and click the **OK** button.

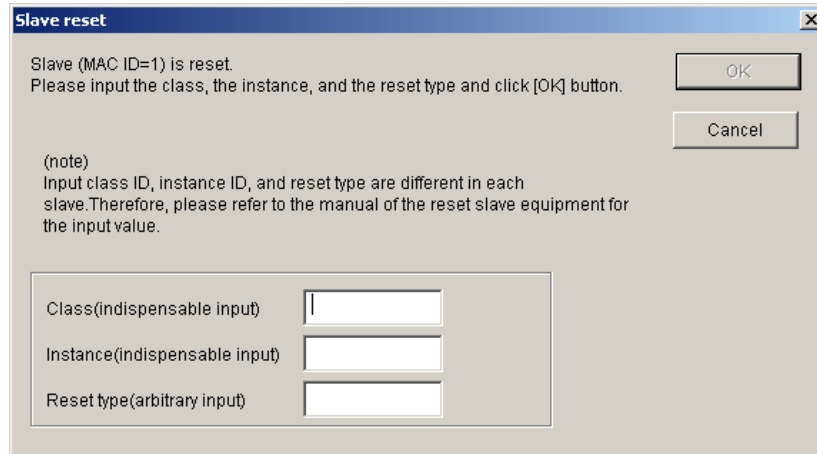

Figure 4-74 The [Slave reset] Window

## (12) Connecting slave to network

Slave devices may be displayed as being in “Non-connection” state within the [Setup slave parameters] window even if they are actually connected to the DeviceNet network. In these cases, click the **Connected state update** button in that window. If the connection state remains unchanged even after the clicking on that button, click the **Request of connection** button, the third button up from the last ([Connected state update]).

Clicking the **Request of connection** button displays the slave connection request window shown below. Click the **OK** button. A connection request will then be issued for the slave device under control of the D.NET module, and the result will be reflected in the slave device’s connection state in the [Setup slave parameters] window.

If you click the **Cancel** button in place of **OK**, no connection request will be issued for the slave device.

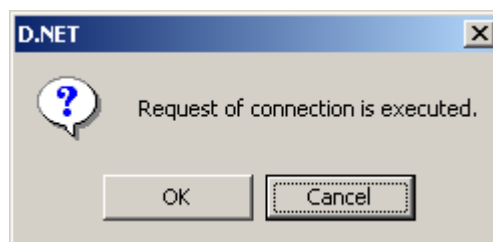

Figure 4-75 The Slave Connection Request Window

(13) Downloading to all existing (but non-connected) slaves at once

When you click the **All download** button in the [Setup slave parameters] window, a confirmation dialog box as shown below appears. The purpose of this confirmation is to confirm whether or not you are downloading the separate sets of slave parameters to all of the existing slave devices that are currently in “Connection” state. Click the **OK** button. The separate sets of slave parameters will then be downloaded.

Note: This downloading process cannot be canceled in its entirety if it is already in progress.

If the **Cancel** button is clicked during the progress of the downloading process, only the downloading to the next node onwards will be canceled.

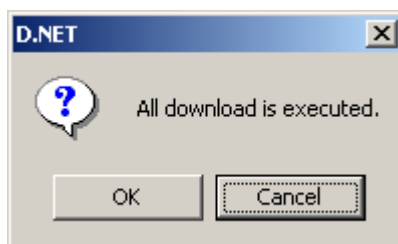

Figure 4-76 A Confirmation Dialog to Confirm Whether or Not You Are Downloading the Separate Sets of Slave Parameters to the Slave Devices Currently in “Connection” State

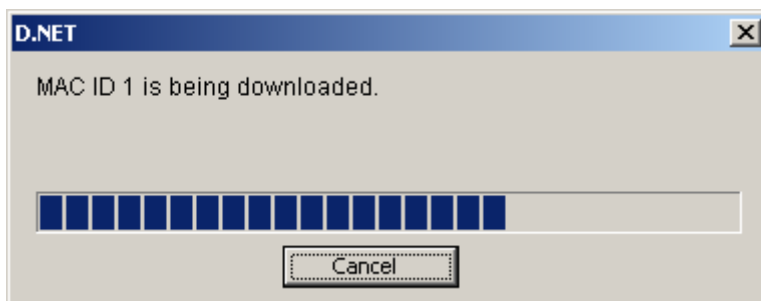

Figure 4-77 The Download-to-All Progress Window

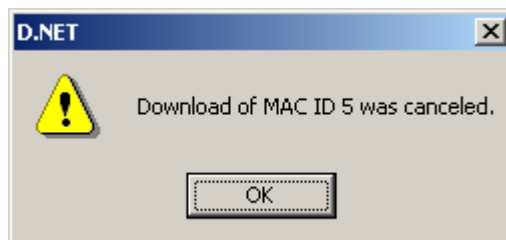

Figure 4-78 A “Download-to-All Canceled” Message



Figure 4-79 The End-of-Download-to-All Window

(14) Uploading from all existing (but non-connected) slaves at once

When you click the **All upload** button in the [Setup slave parameters] window, a confirmation dialog box as shown below appears. The purpose of this confirmation is to confirm whether or not you are uploading the separate sets of slave parameters from all of the existing slave devices that are currently in “Connection” state. Click the **OK** button. The separate sets of slave parameters will then be uploaded.

Note: This uploading process cannot be canceled in its entirety if it is already in progress. If the **Cancel** button is clicked during the progress of the uploading process, only the uploading from the next node onwards will be canceled.

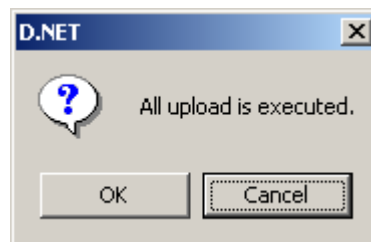

Figure 4-80 A Confirmation Dialog to Confirm Whether or Not You Are Uploading the Separate Sets of Slave Parameters from the Slave Devices Currently in “Connection” State

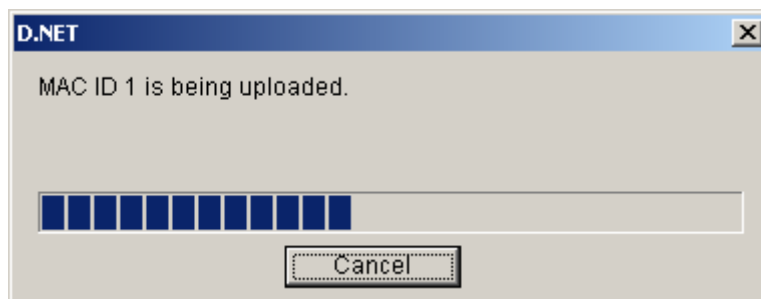

Figure 4-81 The Upload-to-All Progress Window



Figure 4-82 An “Upload-to-All Canceled” Message



Figure 4-83 The End-of-Upload-to-All Window

(15) Updating connection status

Slave devices may be displayed as being in “Non-connection” state within the [Setup slave parameters] window even if they are actually connected to the DeviceNet network. In these cases, click the **Connected state update** button in that window. If the connection state remains unchanged even after the clicking on that button, click the **Request of connection** button, the third button up from the last ([Connected state update]). Clicking the **Connected state update** button re-displays the displayed list in the [Setup slave parameters] window with up-to-date connection state information.

## 4.7 S-Table (Communication Error) Information

This function is used to display error information on non-hardware errors, such as network errors, that have occurred in the D.NET module.

- Click the **S table information** button (for the S10mini) or **Communication error information** button (for the S10V) in the D.NET system's basic window:

(For the S10mini)

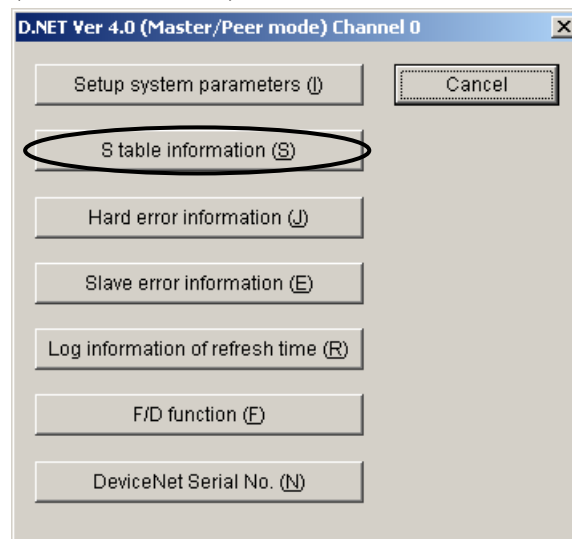

Figure 4-84 The D.NET System's Basic Window 1

(For the S10V)

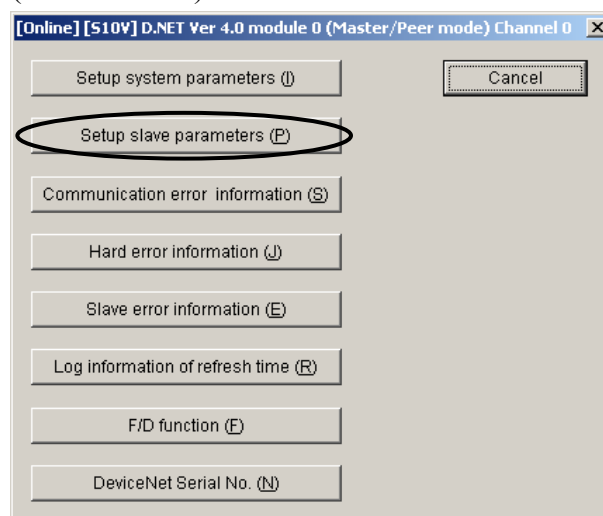

Figure 4-85 The D.NET System's Basic Window 2



## 4 OPERATION

- (2) If a non-hardware error has occurred in the D.NET module, its corresponding code and description will be displayed as shown below. For details on the reported error, see “(2) Network errors (communication stopped)” under “7.3.2 Error indications and required actions.”

(For the S10mini)

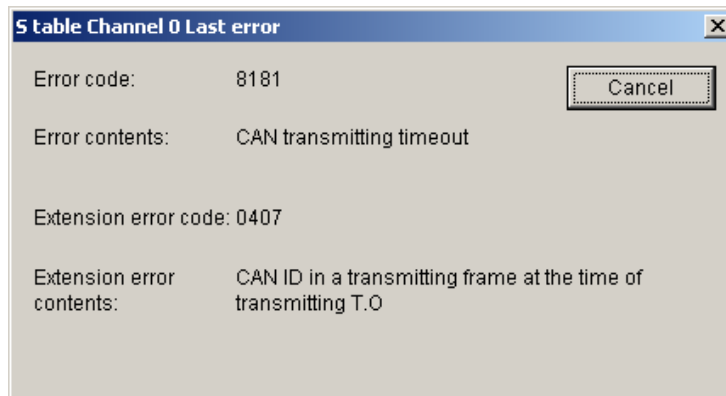

Figure 4-86 CAN Transmission Timeout Error 1

(For the S10V)

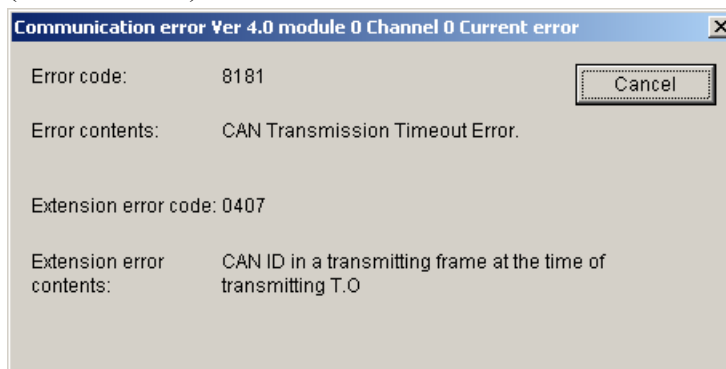

Figure 4-87 CAN Transmission Timeout Error 2

If no such error has occurred in it, the dialog box as shown below will open.



- (3) Click the  or  button in the window or dialog box. The D.NET system's basic window will then become active again.

## 4.8 Hard Error Information

This function is used to display error information on hardware errors that have been detected by the D.NET module.

- (1) Click the **Hard error information** button in the D.NET system's basic window as shown below.

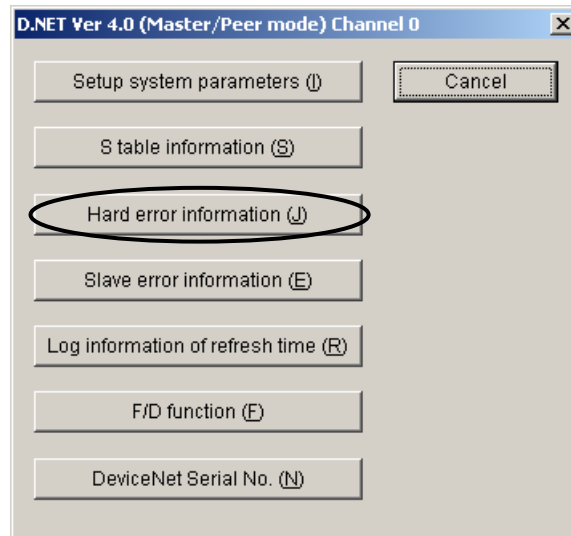

- (2) If a hardware error has been detected by the D.NET module, this function displays its corresponding error code, error description, CAN memory address, write data, and read data. For details on the reported error, see “7.3.2 Error indications and required actions.”

(For the S10mini)

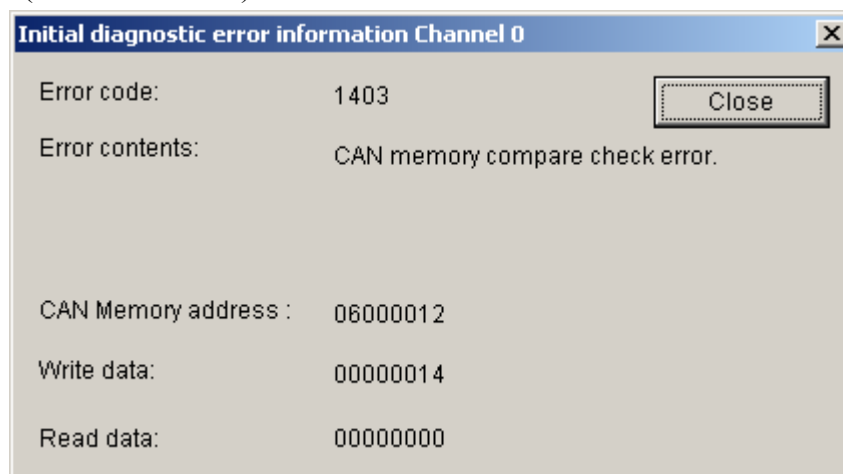

Figure 4-88 The [Initial diagnostic error information] Window 1

(For the S10V)

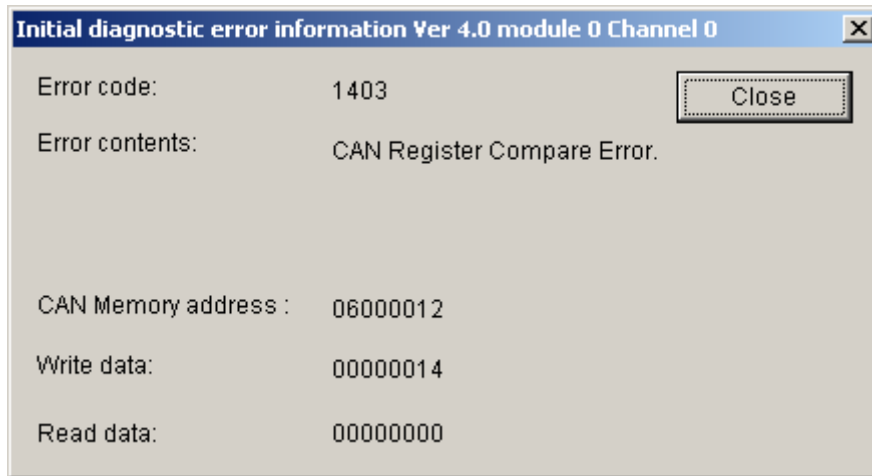

Figure 4-89 The [Initial diagnostic error information] Window 2

If no hardware error has been detected by the module, the dialog box as shown below will open.



- (3) Click the  or  button in the window or dialog box. The D.NET system's basic window will then become active again.

## 4.9 Slave Error Information

This function is used to display error information for slave devices connected to the D.NET module. This error information is meaningful only when the master-peer mode is selected. When the slave mode is selected, all status values (except those of the local D.NET module) are set to “/00” (indicating no slave registered).

- (1) Click the **Slave error information** button in the D.NET system’s basic window as shown below.

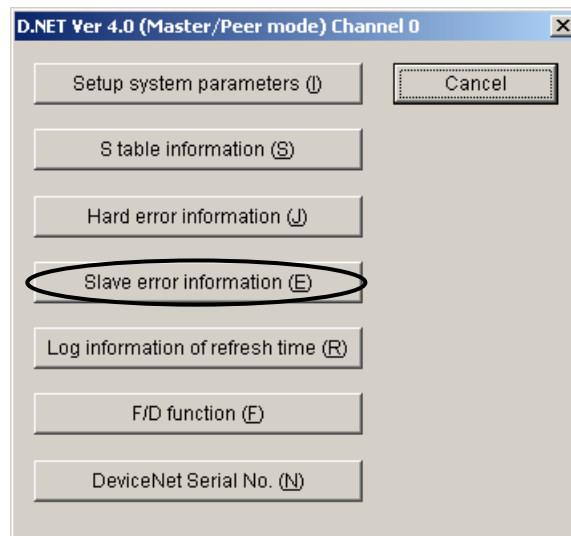

- (2) The status of the slave identified by each MAC ID is displayed as shown below.

(For the S10mini)

The screenshot shows a window titled "Slave error information Channel 0" with a table of slave status information. The table has three columns: MAC ID, Slave state val..., and Contents. The data is as follows:

MAC ID	Slave state val...	Contents
00	00	No registration
01	--	Self-node
02	00	No registration
03	00	No registration
04	00	No registration
05	00	No registration
06	00	No registration
07	00	No registration
08	00	No registration
09	00	No registration
0A	00	No registration
0B	00	No registration
0C	00	No registration
0D	00	No registration
0E	00	No registration
0F	00	No registration
10	00	No registration
11	00	No registration

Figure 4-90 The [Slave error information] Window 1

(For the S10V)

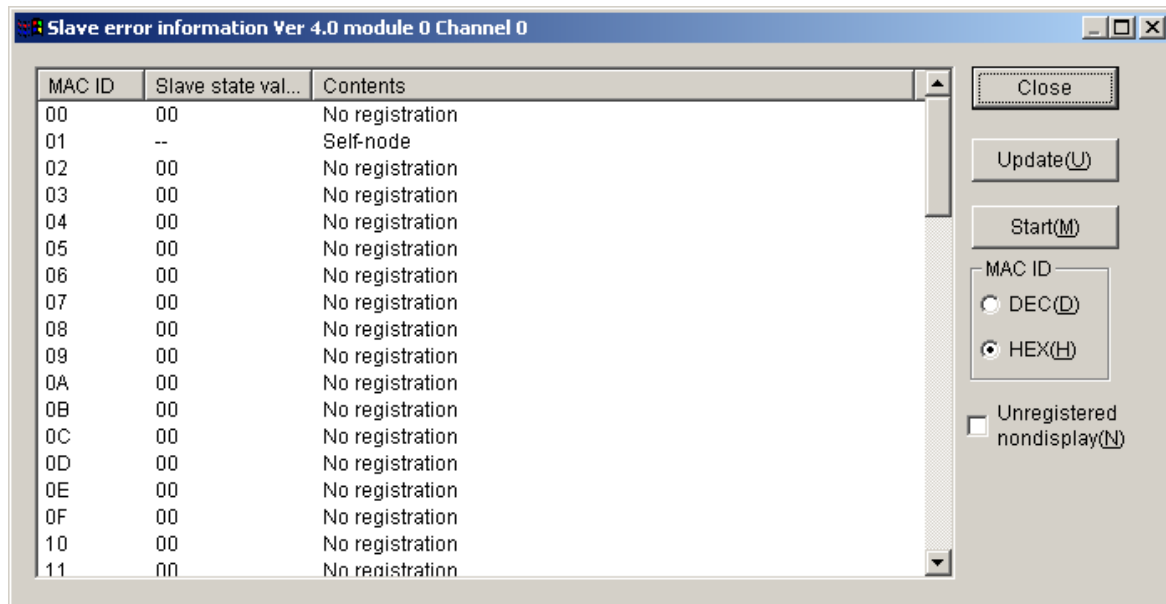

Figure 4-91 The [Slave error information] Window 2

## &lt;Switching the MAC ID notation system&gt;

You can display MAC IDs in decimal or hexadecimal notation by clicking the desired radio button in the MAC ID DEC/HEX box. By default, they are displayed in hexadecimal notation.

- Clicking the [DEC(D)] radio button displays MAC IDs in decimal.
- Clicking the [HEX(H)] radio button displays MAC IDs in hexadecimal.

## &lt;Updating slave error information&gt;

By clicking the [Update] button, you can read out the current slave error information once and display it on-screen.

## &lt;Monitoring slave error information&gt;

By clicking the [Start] button, you can read out slave error information at intervals of about 100 ms and display it on-screen as it is read out. Once such monitoring starts, the [Update] button is no longer able to be clicked and the [Start] button is replaced by the [Stop] button.

When you click the [Stop] button during the monitoring and display process, the process stops, the [Update] button again becomes able to be clicked, and the [Stop] button is replaced by the [Start] button.

## &lt;Hiding non-registered MAC IDs&gt;

You can hide all non-registered MAC ID information from view by selecting the [Unregistered nondisplay] check box. In this case, only the registered MAC ID information is displayed starting from the top of the list.

If you deselect the [Unregistered nondisplay] check box, all registered and non-registered MAC ID information is displayed. By default, the [Unregistered nondisplay] check box is deselected.

The table below is a list of all slave status values and their meanings.

Table 4-1 Slave Status Values

No.	Slave status value	Meaning
1	0x00	No slave registered.
2	0x01	A connection is being established.
3	0x02	A connection has been established normally (this state lasts during normal communication).
4	0x80	A timeout occurred (establishment of an Explicit connection failed).
5	0x81	A timeout occurred (establishment of an I/O [Poll] connection failed).
6	0x82	A timeout occurred (establishment of an I/O [Bit Strobe] connection failed).
7	0x83	A timeout occurred (establishment of an I/O [Bit Strobe] connection failed, but an I/O [Poll] connection was established successfully).
8	0x84	A timeout occurred (acquisition of the produced connection size on the I/O [Poll] slave side failed).
9	0x85	A timeout occurred (acquisition of the consumed connection size on the I/O [Poll] slave side failed).
10	0x86	A timeout occurred (explicit EPR setting failed).
11	0x87	A timeout occurred (Poll EPR setting failed).
12	0x88	A timeout occurred (Bit Strobe EPR setting failed).
13	0x89	A timeout occurred (Bit Strobe EPR setting failed, but I/O (Poll) EPR setting was done successfully).
14	0x90	A Poll response timeout occurred.
15	0x91	A Bit Strobe response timeout occurred.
16	0x11	Establishment of an Explicit connection failed (Open Explicit error).
17	0x12	Establishment of an Explicit connection failed (an Explicit connection already open could not be opened).
18	0x13	Establishment of an Explicit connection failed (an Explicit connection already made with another master could not be opened).
19	0x14	Establishment of an Explicit connection failed (an Explicit connection could not be opened due to a Master/Slave [M/S] service error).
20	0x15	Establishment of an Explicit connection failed (an Explicit connection could not be opened due to an M/S service connection already established).
21	0x16	Establishment of an I/O (Poll) connection failed (an error response was received).
22	0x17	Establishment of an I/O (Poll) connection failed (an I/O connection was already established).
23	0x18	Establishment of an I/O (Poll) connection failed (an I/O connection already connected to another master could not be opened).
24	0x19	Establishment of an I/O (Bit Strobe) connection failed (an error response was received).
25	0x1A	Establishment of an I/O (Bit Strobe) connection failed (an error response was received), but an I/O (Poll) connection was established successfully.
26	0x1B	Establishment of an I/O (Bit Strobe) connection failed (an I/O connection was already established).
27	0x1C	Establishment of an I/O (Bit Strobe) connection failed (an I/O connection was already established), but an I/O (Poll) connection was established successfully.
28	0x1D	Establishment of an I/O (Bit Strobe) connection failed (a connection already established with another master could not be opened).
29	0x1E	Establishment of an I/O (Bit Strobe) connection failed (a connection already established with another master could not be opened), but an I/O (Poll) connection was established successfully.
30	0x21	EPR setting failed (Explicit).
31	0x22	EPR setting failed (I/O [Poll]).
32	0x23	EPR setting failed (I/O [Bit Strobe]).
33	0x24	EPR setting failed (I/O [Bit Strobe]), but I/O (Poll) EPR setting was done successfully.
34	0x31	The produced connection size on the slave side supporting I/O (Poll) connections was found not matching the D.NET module.
35	0x32	The consumed connection size on the slave side supporting I/O (Poll) connections was found not matching the D.NET module.
36	0x33	Acquisition of the produced connection size on the slave side supporting I/O (Poll) connections failed.
37	0x34	Acquisition of the consumed connection size on the slave side supporting I/O (Poll) connections failed.
38	0x2D	EPR setting during I/O communication failed (an error response was received).
39	0x2E	EPR setting during I/O communication failed (a response timeout occurred).
40	0x2F	Acquisition of I/O status information failed.
41	0x50	Establishment of an Explicit connection failed (it was already assigned).
42	0x51	Establishment of an Explicit connection failed (it was in a condition other than already open and assigned).
43	0x52	Establishment of an Explicit connection failed (it was already open).
44	0x70	Release of a Group 3 Explicit connection failed.
45	0x8A	Establishment of an Explicit connection failed (a response timeout occurred).
46	—	Local station

If any of the above errors (except the status “0x02”) occurs, check the parameter settings, wiring, etc.

### 4.10 Refresh Time Log Information

This function is used to display the currently used actual refreshing cycles of peer transmission and master/slave communication. By using this function, you can learn the actual cycles in which refreshing is currently performed.

- (1) Click the Log information of refresh time button in the D.NET system's basic window as shown below.

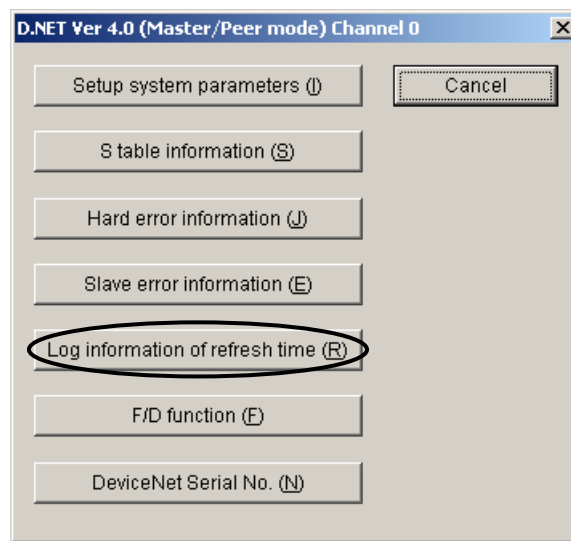

- (2) The [Log information of refresh time] window as shown below appears. In this window, each refresh time is the time that has actually been being used at the time the window was opened.

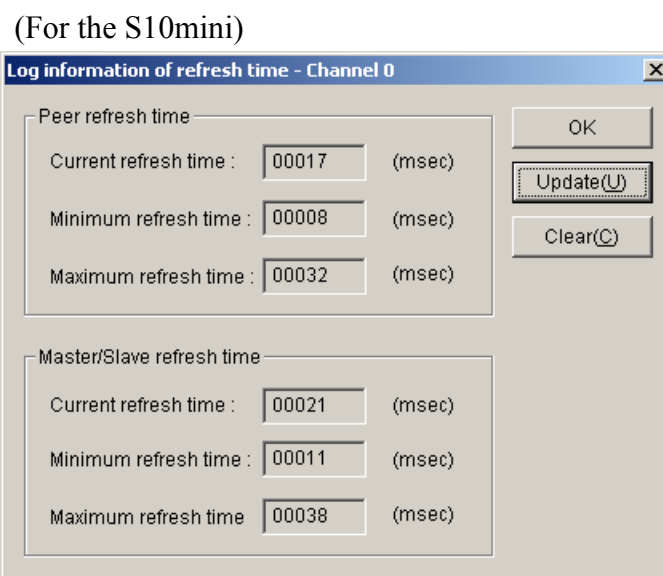

Figure 4-92 The [Log information of refresh time] Window 1

(For the S10V)

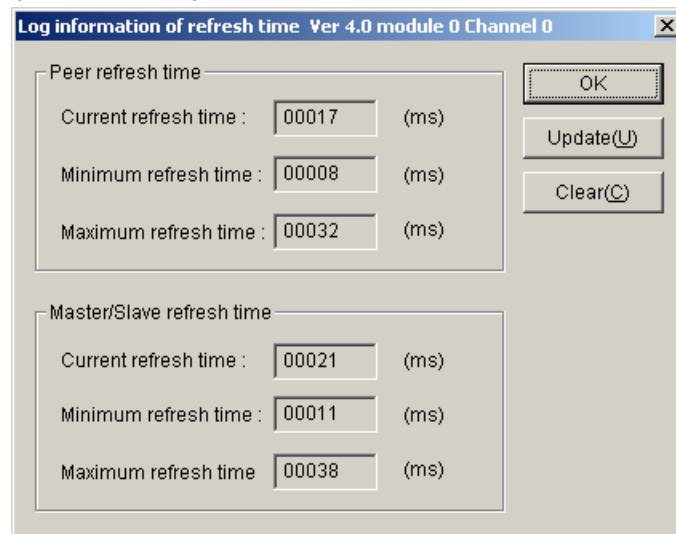

Figure 4-93 The [Log information of refresh time] Window 2

After this, if you want to display the latest refresh time, click the **Update** button. If you want to clear the refresh time, click the **Clear** button.

When quitting this function, click the **OK** button.



## 4 OPERATION

### 4.11 F/D Function

This function is used for the purposes: 1) to save the system parameters and station parameters set in the D.NET module to the personal computer, 2) to send (load) the saved parameters from the personal computer to the D.NET module, and 3) to compare the saved parameters in the personal computer with the parameters set in the D.NET module.

To use this function, first click the **F/D function** button in the D.NET system's basic window as shown below.

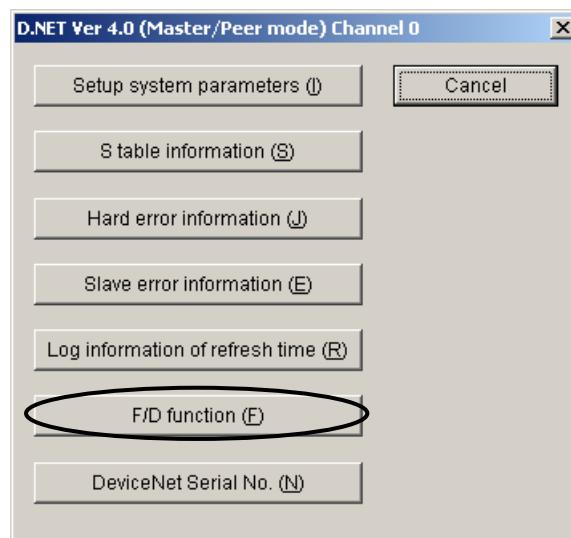

Then, select the desired operation by clicking either the **Save** , **Send** , or **Compare** button in the F/D window as shown below. The selected operation will then start. Here, you should note that the F/D function will not use channel 1 if the D.NET module used is a model LQE570 or LQE575 D.NET module.

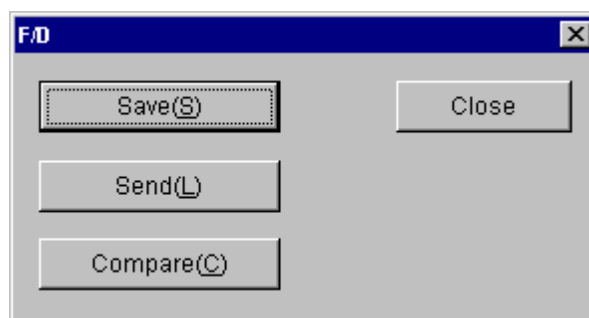

### **NOTICE**

You can add a comment to a file when saving the parameters to it. This comment, called a file comment, is limited to 128 characters in length.

## 4.11.1 Save

If you click the **Save** button in the F/D window, the [Save As] window as shown below will open.

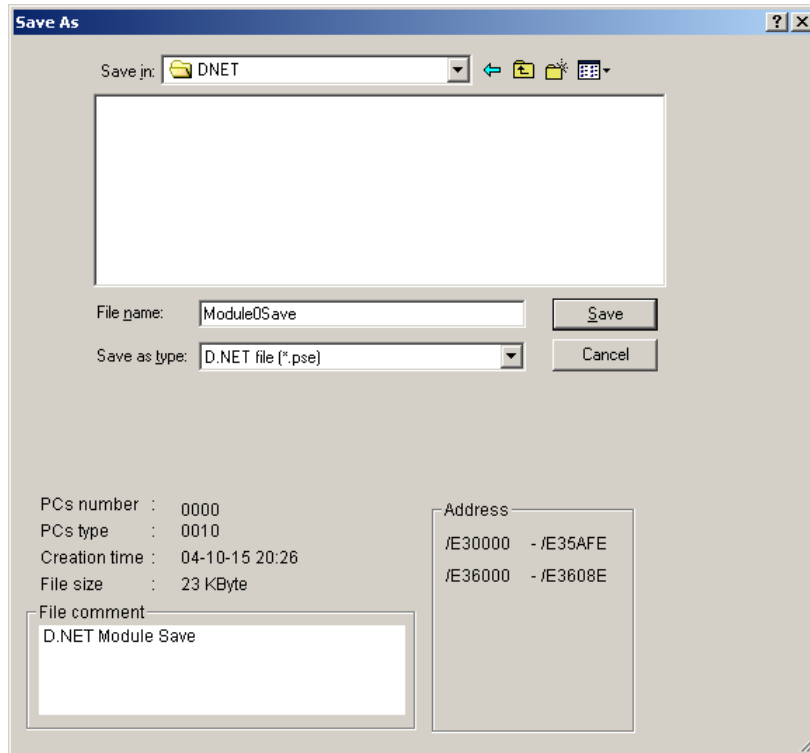

Figure 4-94 The [Save As] Window

The save area to be subjected to saving varies with the module and channel numbers selected (see Table 4-2). Here, you should note that the F/D function will not use channel 1 if the D.NET module used is a model LQE570 or LQE575 D.NET module.

Table 4-2 Save Areas for Module and Channel Numbers

	Module 0	Module 1	Module 2	Module 3	Size (bytes)
Channel 0	/E30000 – /E35AFE	/E70000 – /E75AFE	/EB0000 – /EB5AFE	/EF0000 – /EF5AFE	23296
	/E36000 – /E3608E	/E76000 – /E7608E	/EB6000 – /EB608E	/EF6000 – /EF608E	144
Channel 1	/E10E00 – /E168FE	/E50E00 – /E568FE	/E90E00 – /E968FE	/ED0E00 – /ED68FE	23296
	/E16E00 – /E16E8E	/E56E00 – /E56E8E	/E96E00 – /E96E8E	/ED6E00 – /ED6E8E	144

Then, follow the instructions given below to save the system parameters and station parameters set in the D.NET module to your personal computer.

## 4 OPERATION

---

- (1) Enter the file name of the file to which to save the parameters. If you select a file name displayed in the [Save As] window, the file identified by it will be overwritten.
- (2) If you want to add a comment to the file, enter a string of up to 128 characters in the “File comment” box. If entered, this file comment will be displayed when the file is selected for a send or compare operation using the F/D function. If you need not add it, leave the box blank.
- (3) Click the  button. The [Receive file] window as shown below opens.

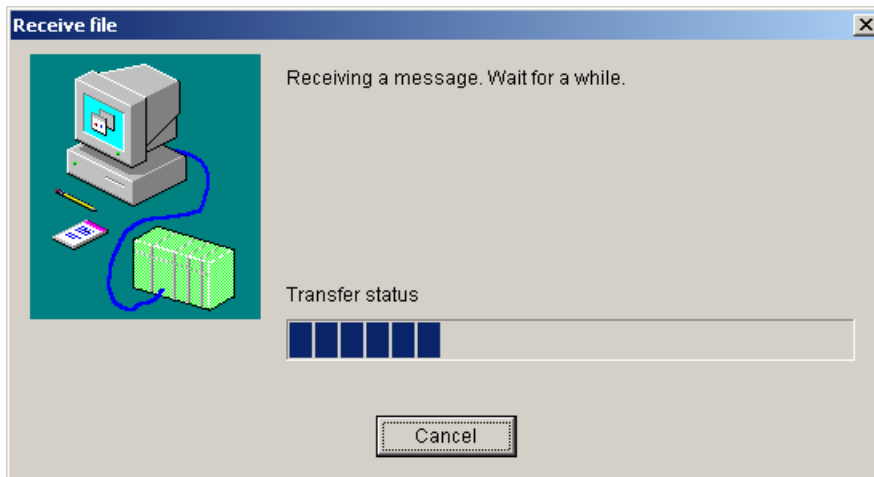

Figure 4-95 The [Receive file] Window

If you click the  button during the file reception in progress, the dialog box shown below will appear.



Figure 4-96 The File Reception Abortion Message Dialog Box

In this case, the specified file is not created. Note that, if the file was being overwritten, it is deleted. Click the  button.

- (4) If the file reception is completed, the dialog box shown below will open. Click the  button.



Figure 4-97 The File Reception Completion Message Dialog Box

The save operation using the F/D function is now complete.

## 4 OPERATION

### 4.11.2 Send

Note: The Send option of the F/D function requires the resetting of the CPU unit (for the S10mini) or LPU unit (for the S10V).

First of all, click the **Send** button in the [F/D] window to open the [Open] window:

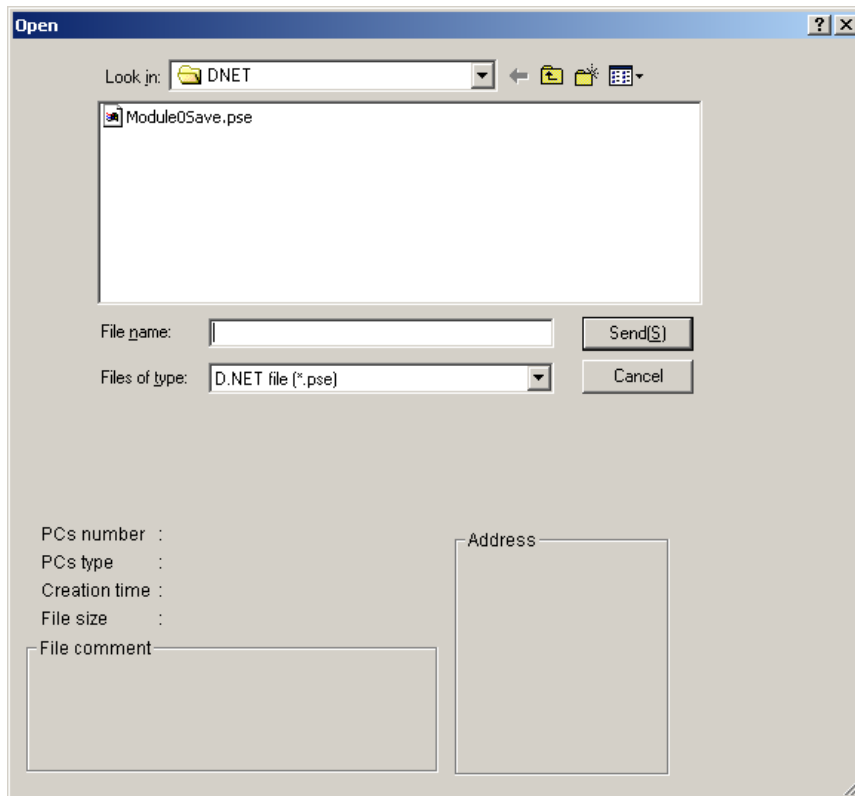

Figure 4-98 The [Open] Window

When it is opened, follow the instructions given below to send to the D.NET module a file that has previously been saved with the [Save] option of the F/D function.

- (1) Either select a file in the [Open] window or enter a file name directly in the “File name” box. If you select a file in the [Open] window, all of the PCs number, PCs type, file creation date and time, file size (in KB), file comment (if any), and destination addresses fetched from that file will be displayed in the [Open] window, as shown in Figure 4-56. If you enter a file name directly in the “File name” box, no such information will be displayed.

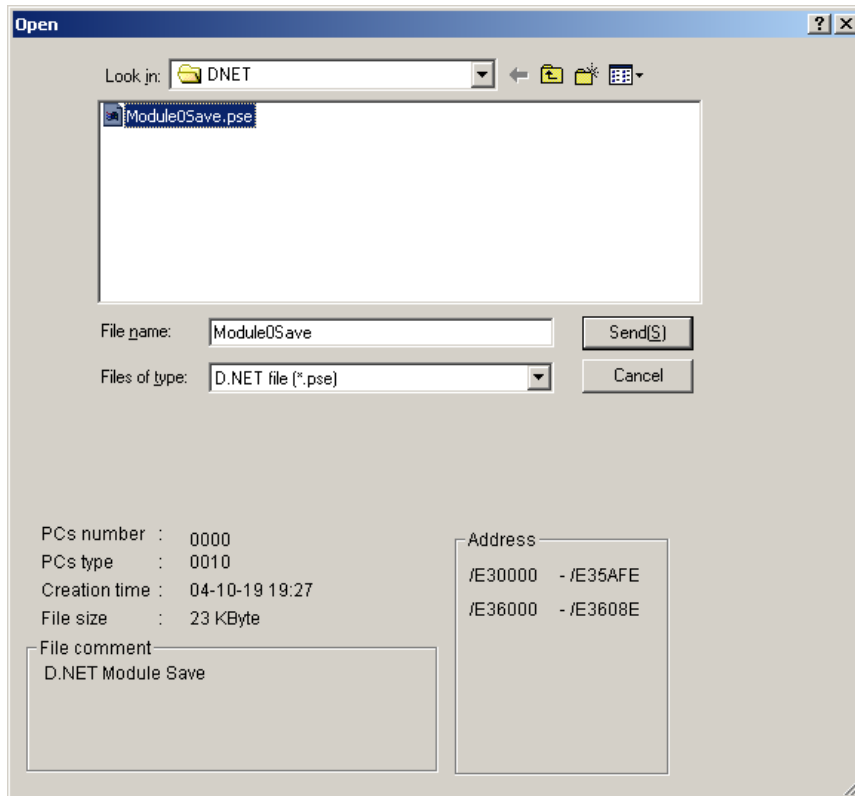

Figure 4-99 The [Open] Window (displayed when a file is selected)

- (2) Click the **Send** button in the [Open] window. The [Send file] window as shown below will then open.

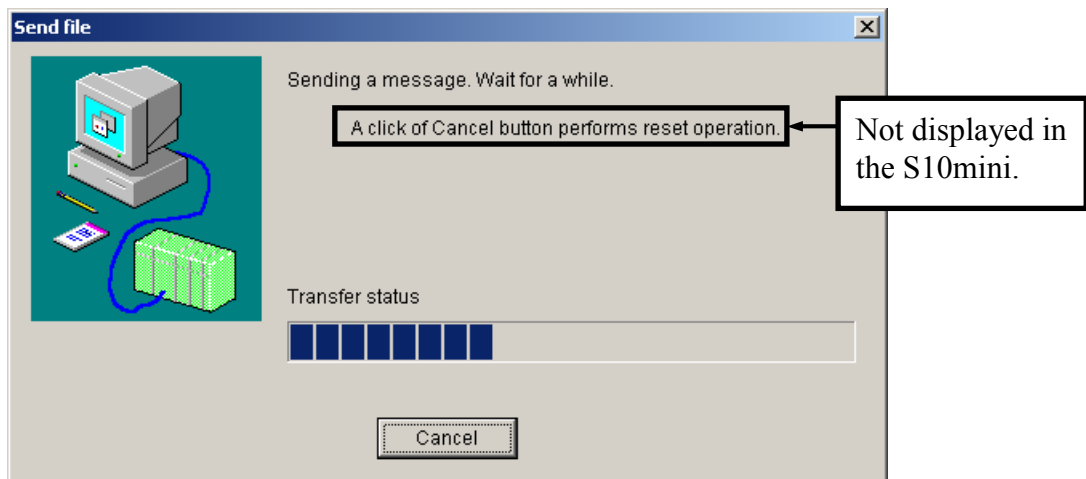

Figure 4-100 The [Send file] Window

During the file transmission in progress, do not click the **Cancel** button. If it is clicked, the file transmission will stop immediately and the reset sequence will be automatically performed. (This is the case only with the S10V. With the S10mini, the user must reset the PCs manually, or power it down and then up again.)

## 4 OPERATION

---

- (3) The reset confirmation message dialog box shown below will appear. When it appears, click the  button.

The LPU unit will then be automatically reset.



Figure 4-101 The PCs Reset Confirmation Message Dialog Box

- (4) The end-of-transmission message shown below will appear. When it appears, click the  button.



Figure 4-102 The End-of-Transmission Message Dialog Box

The send operation using of the F/D function is now complete.

### 4.11.3 Compare

To use the Compare option of the F/D function, first click the **Compare** button in the [F/D] window. Then, the [Open] window as shown below opens.

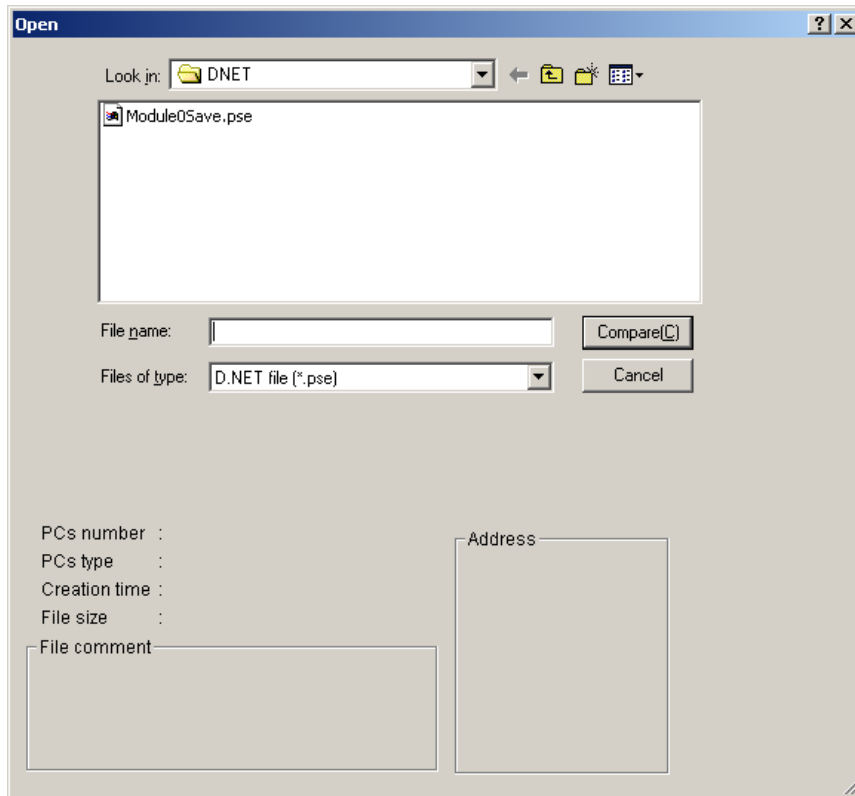

Figure 4-103 The [Open] Window

After this, follow the instructions given below to compare the file previously saved by the Save option of the F/D function with the parameters set in the D.NET module.

- (1) Either select a file in the [Open] window or enter a file name directly in the “File name” box. If you select a file in the [Open] window, all of the PCs number, PCs type, file creation date and time, file size (in KB), file comment (if any), and destination addresses fetched from that file will be displayed in the [Open] window, as shown in Figure 4-61. If you enter a file name directly in the “File name” box, no such information will be displayed.



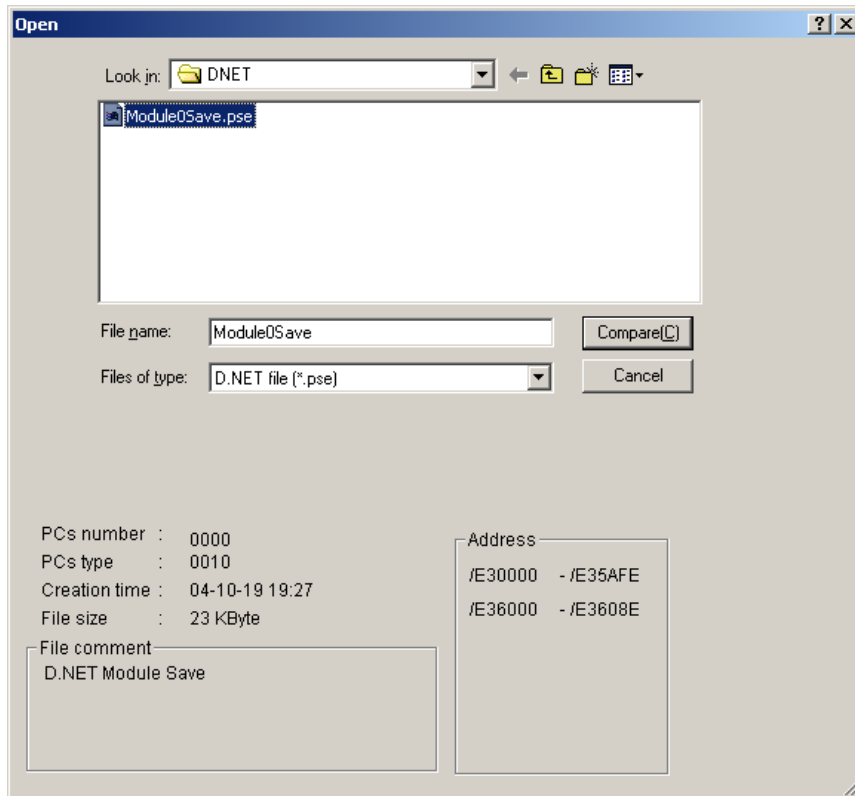

Figure 4-104 The [Open] Window (displayed when a file is selected)

- Click the **Compare** button in the [Open] window. The [Compare file] window as shown below will open and file comparison will start.  
If you click the **Cancel** button during the file comparison in progress, the file comparison will stop immediately.

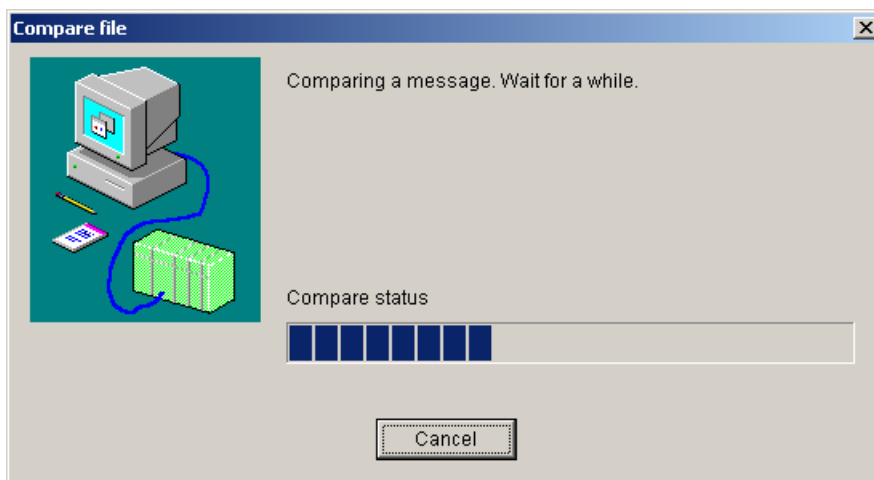

Figure 4-105 The [Compare file] Window

(3) If no difference is found between the two, the dialog box shown below will open.

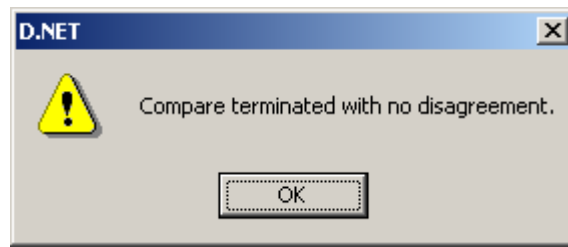

Figure 4-106 The End-of-Comparison with No Difference Found Message

## 4 OPERATION

If a difference is found, the [Memory contents] windows as shown below will open.

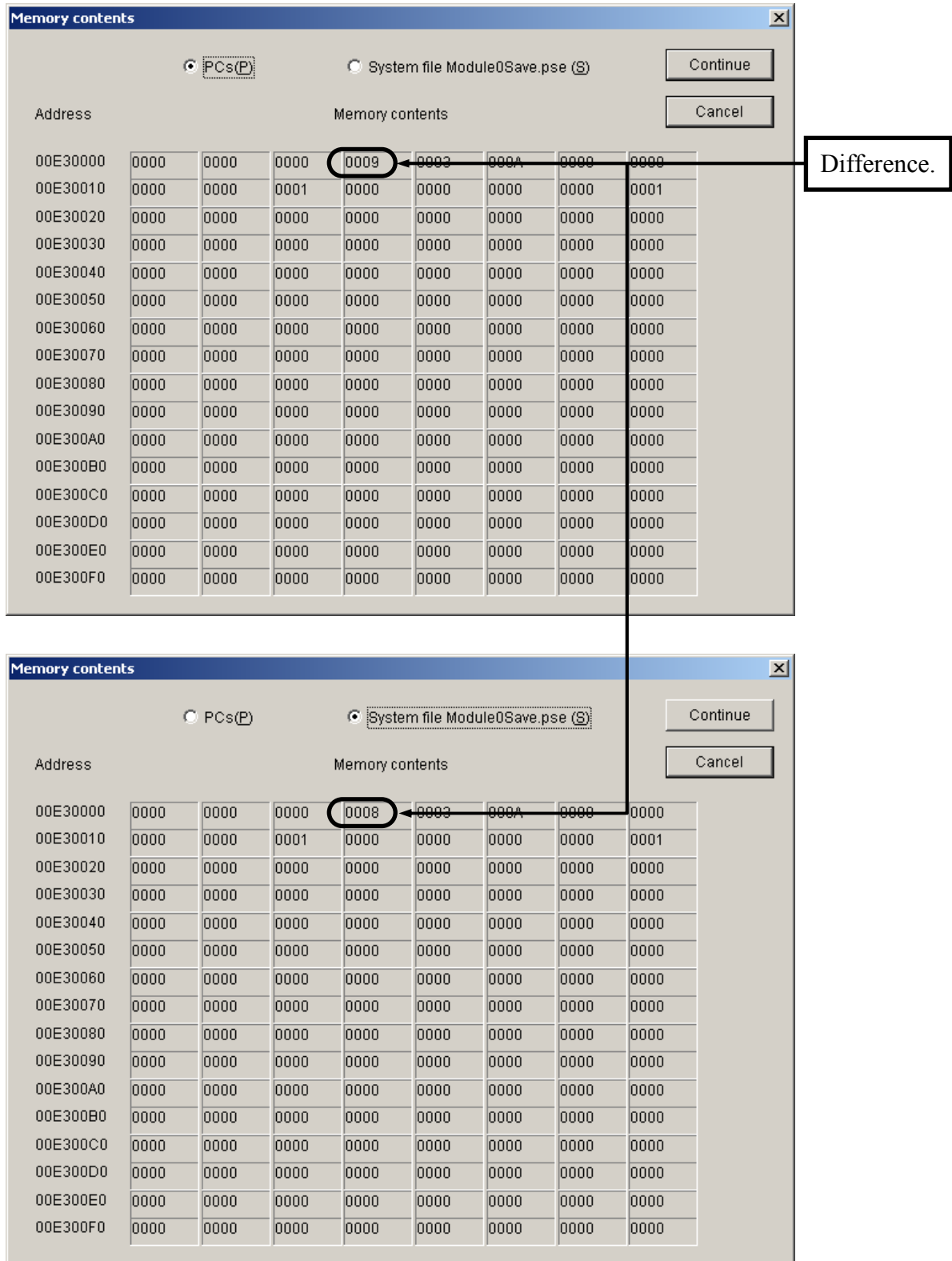

Figure 4-107 The [Memory Contents] Windows showing a Difference

Then, if you click the  button, the [Memory contents] windows will close and the file comparison will resume. If another difference is detected during the file comparison, the [Memory contents] windows will open again.

If you click the  button instead of the  button, the file comparison will stop immediately and the [Memory contents] windows will close.

If the file comparison is ended or canceled with a further difference detected, the dialog box as shown below will open. In this case, just click the  button. The dialog box and [Compare file] window (Figure 4-62) will then close.

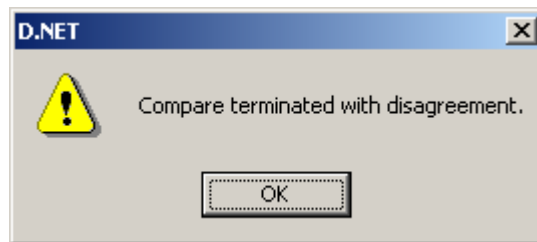

Figure 4-108 The End-of-Comparison Message Reporting a Further Difference

Here, note the following: If a file that has been saved and then downloaded by the Save and Send options of the F/D function is compared with the set parameters by its Compare option, differences (in FROM write count, which is represented by four bytes) will be found at the addresses listed in Table 4-3, except for the addresses listed in the second row of this table, which may be found identical.

Table 4-3 Addresses at which Differences Are Found during Comparison by the F/D Function

	Module 0	Module 1	Module 2	Module 3
	Channel 0	Channel 0	Channel 0	Channel 0
Addresses at which differences (in FROM write count) are found	0xE30004	0xE70004	0xEB0004	0xEF0004
	0xE30006	0xE70006	0xEB0006	0xEF0006

4.12 DeviceNet Serial No.

The DeviceNet serial number is a product-specific ID number conforming to the DeviceNet standard. This feature requires no parameter setting.

Simply click the DeviceNet Serial No. button in the D.NET system's basic window as shown below.

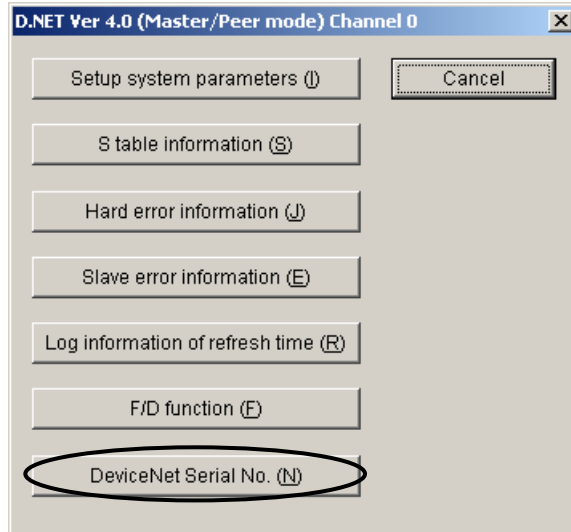

The DeviceNet serial number is displayed as shown below.

(For the S10mini)

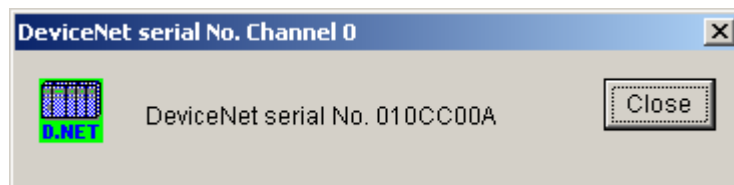

Figure 4-109 The [DeviceNet serial No.] Window 1

(For the S10V)

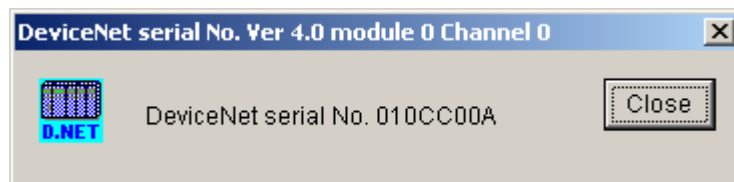

Figure 4-110 The [DeviceNet serial No.] Window 2

## 4.13 Version Information

This function enables you to check out the version of the D.NET system you are using. The version displayed by this function is not the version-revision of the D.NET module.

To check it out, do the following:

When the channel selection dialog box as shown below appears, click the “D.NET” icon in the upper left corner of that dialog box and select “Version information.”

(For the S10mini)

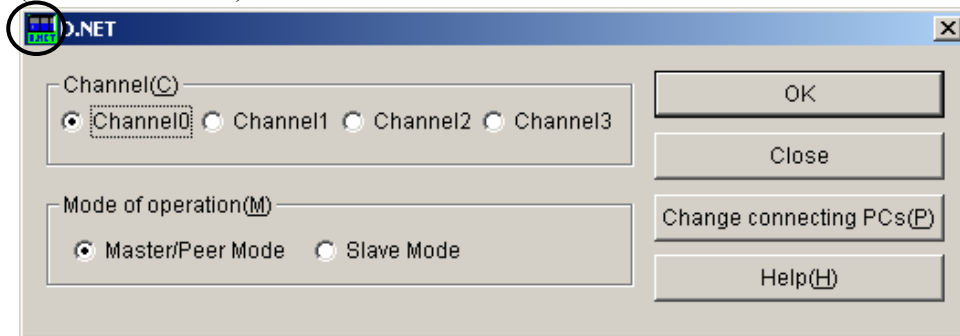

(For the S10V)

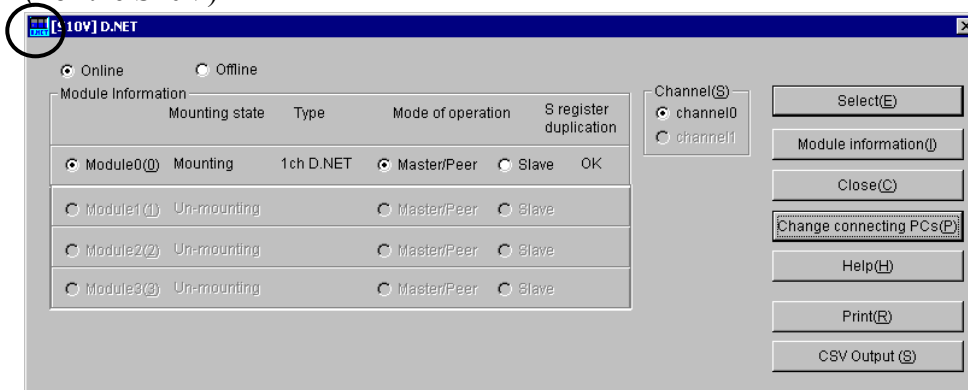

The version of the D.NET system is then displayed as shown below.

(For the S10mini)

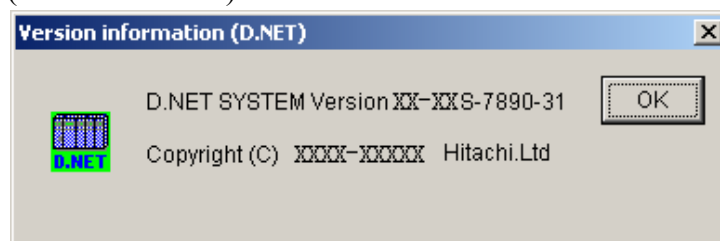

(For the S10V)

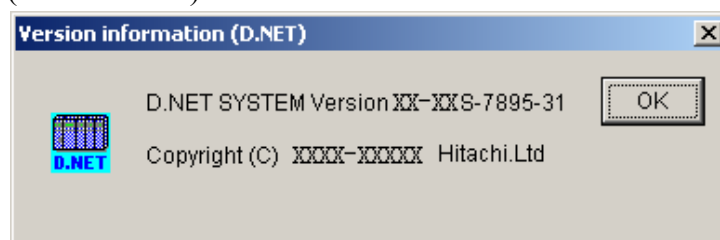

### 4.14 Selecting an Edition File

The D.NET system allows you to choose one of the following two types of edition files for editing:

- D.NET file

The D.NET file is a file in which all necessary system parameters and station parameters are saved for future setting in the D.NET module.

- Slave parameter setting file

The slave parameter setting file is a file in which all necessary slave parameters are saved, along with the contents of the EDS file, for future setting in a DeviceNet slave device.

#### 4.14.1 Selecting a D.NET file

The D.NET file you can choose is either a file that you previously saved with the “Save” command of the F/D function or a file that you have already created as such in offline mode. You can also create a new file by specifying a non-existing file name. This function is supported only in S10V controller systems.

The procedure used is shown below.

- (1) Select the [Offline] radio button in the D.NET system’s main window (Figure 4-3). If it is already selected, skip this step.
- (2) If you have not selected an edition file yet or want to change the currently selected edition file, click the Edition file select button. The [Open] window as shown below will then appear.

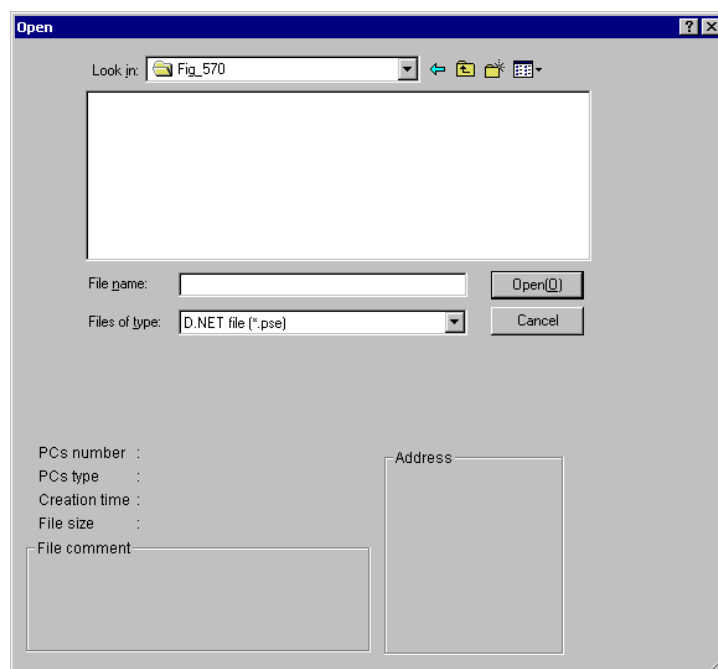

Figure 4-111 [Open] Window -- an Example

- (3) If you want to create a new D.NET setup information file and edit its content, enter a non-existing unique file name and click the **Open** button. The [Creation confirmation] dialog box as shown below will then appear. When it appears, choose the desired module, type, and channel, and click the **OK** button.

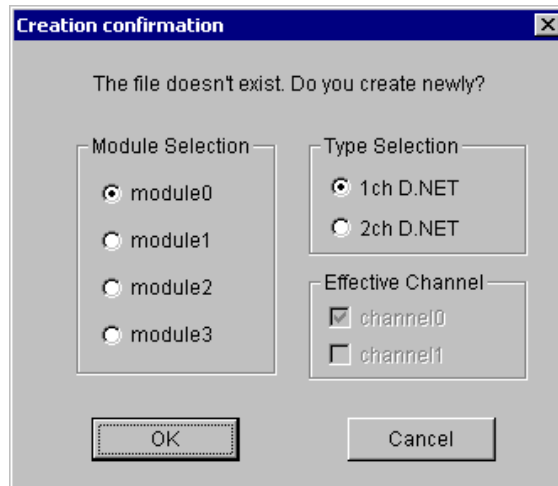

Figure 4-112 [Creation confirmation] Dialog Box

- (4) If you want to edit an already created D.NET setup information file, choose that file in the [Open] window. Then, when the associated “PCs number” (in decimal), “PCs type” (in hexadecimal), and other information are displayed, click the **Open** button. If the selected file is a non-D.NET setup info file or invalid file, the error message dialog box shown below will appear.



Figure 4-113 Error Message Dialog Box Reporting on an Invalid D.NET Setup Info File Specified

If the selected file is a valid D.NET setup info file, you can now edit the setup information in that file as you do while the D.NET system is running in online mode.



## 4 OPERATION

### 4.14.2 Selecting a slave parameter setting file

The slave parameter setting file you can choose for editing in an online or offline state is either an edition file you previously saved as such or an edition file you have already created as such. If a nonexistent file name is specified, a new edition file will be created under the specified file name. The procedure used is described below, where Step (1) can be used only in offline mode and Step (2) onwards can be used in both offline and online modes.

- (1) Choose the desired D.NET file. For information on how, see “4.14.1 Selecting a D.NET file.”
- (2) Click the **Select** button in the module/channel selection window (or dialog box). The D.NET system’s basic window then appears.
- (3) Click the **Setup slave parameters** button in the basic window. The [Setup slave parameters] window then appears.
- (4) Click the **Open** button in the [Setup slave parameters] window. The [Open] window as shown below then appears.

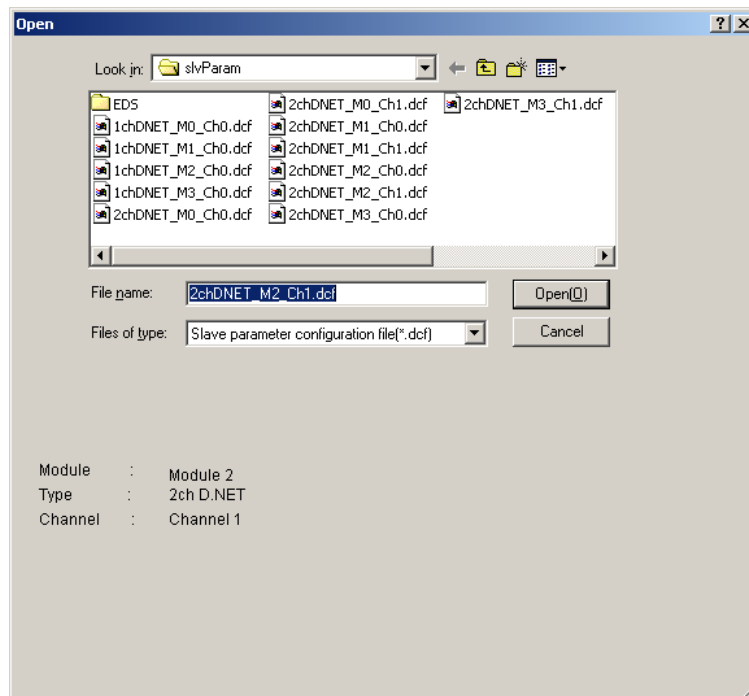

Figure 4-114 The [Open] Window with a Slave Parameter Setting File Selected

- (5) If you want to create a new slave parameter setting file for later editing, enter a nonexistent unique file name in the “File name” edit box and click the  button. Then, a confirmation dialog box as shown below appears to confirm whether or not you are creating a new file.

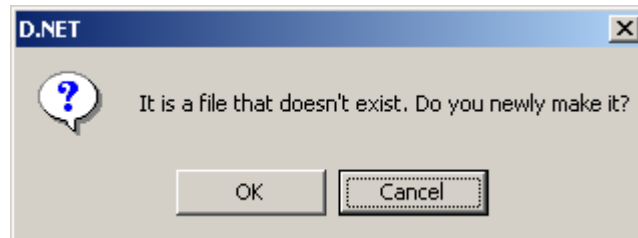

Figure 4-115 A Confirmation Dialog to Confirm Whether or Not You Are Creating a New Slave Parameter Setting File

- (6) If you want to open an already created slave parameter setting file for editing, choose the desired slave parameter setting file in the [Open] window. The module number, type, and channel number of the D.NET module used with the selected slave parameter setting file will then be displayed in that window. Check that the reported D.NET module is the correct one, and click the  button in that window. If the selected file is a genuine slave parameter setting file, its contents will be presented in the [Setup slave parameters] window.

### 4.15 Printing

The function of commands used for this purpose is to print on the printer one of the following two pieces of information: 1) the setup information for a selected module or channel from the actual target machine if the D.NET system is running in online mode; or 2) the content (setup information) of a selected file if it is running in offline mode. This function is supported only in S10V controller systems.

The procedure used is shown below.

- (1) If the D.NET system is running in online mode, establish a connection between the D.NET system and the PCs (see “4.3 Change of Connection with PCs”). If it is running in offline mode, choose the desired edition file (see “4.14 Selecting an Edition File”).
- (2) In the D.NET system’s main window, choose the desired module or channel and click the **Print** button.
- (3) The [Print] dialog box appears. In this dialog box, specify the desired printer and its properties, and then click the **OK** button.

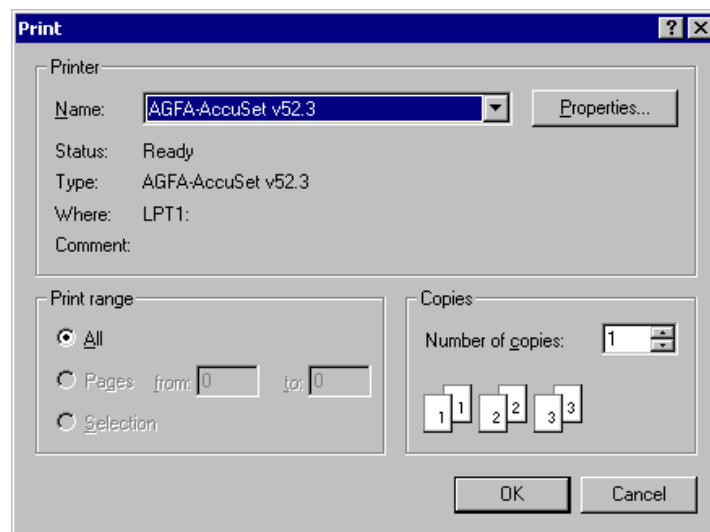

Figure 4-116 [Print] Dialog Box

## &lt;Sample printout&gt;

```

D.NET    2006/10/31    19:54:59
File Name= C:\Documents and Settings\Administrator\Desktop\Nai\aaa\Settings\lch.pse

Module No      1
Kind          lch D.NET
Channel       0
Mode of operation Master/Peer

Setup system parameters
Channel       ----
Node Address  ----
Transmission speed ----
Peer refresh time 50[ms]
M/s refresh time 50[ms]
Slave T.O. detect reg. No Use
Cooperation with PCs OK No Use

Setup station parameters
No  Com kind      MAC ID  Mes ID  I address      I bytes  O address      O bytes  Bit rev  Byte rev  Time of T.O  D.ST  Status  Info
/01 Poll         /02  --   --   FW000-FW008    /012    FW020-FW021    /004    --      Enable   400        --    --      --
/02 Poll         --   --   --   --             --      --             --      --      --        --    --      --
/03 Poll         --   --   --   --             --      --             --      --      --        --    --      --
/04 Poll         /03  --   --   FW100-FW103    /008    FW108-FW108    /008    Enable  Enable   400        --    --      --

Setup data format conversion of D.STATION
No  Module          Input address      Output address      Assignment data area

```

### 4.16 CSV Output

The function of this command is to output to a file in CSV format one of the following two pieces of information: 1) the setup information for a selected module or channel from the actual target machine if the D.NET system is running in online mode; or 2) the content (setup information) of a selected file if it is running in offline mode. This function is supported only in S10V controller systems.

The procedure used is shown below.

- (1) If the D.NET system is running in online mode, establish a connection between the D.NET system and the PCs (see “4.3 Change of Connection with PCs”). If it is running in offline mode, choose the desired edition file (see “4.14 Selecting an Edition File”).
- (2) In the D.NET system’s main window, choose the desired module or channel and click the **CSV Output** button.
- (3) The [Save As] dialog box appears. In this dialog box, specify the desired folder and file to which you want to output the setup information, and then click the **Save** button.

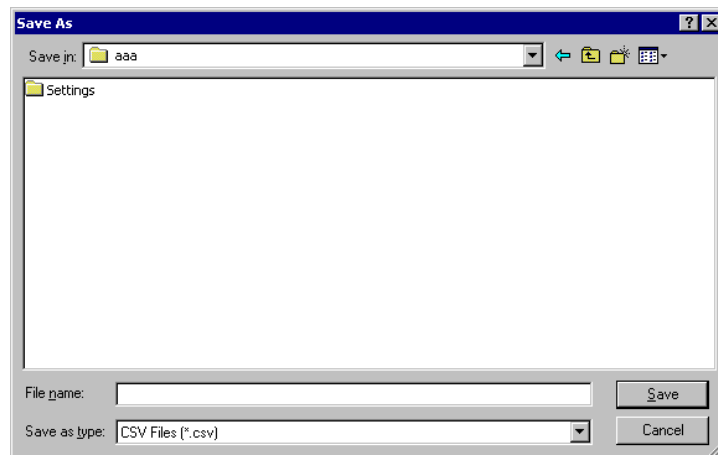

Figure 4-117 [Save As] Dialog Box

## &lt;Sample CSV file output&gt;

```
D.NET    2006/10/31    19:56:07
File Name= C:\Documents and Settings\Administrator\Desktop\Nai\aaa\Settings\1ch.pse

Module No,1
Kind,1ch D.NET
Channel,0
Mode of operation, Master/Peer

Setup system parameters
Channel,----
Node Address,----
Transmission speed,----
Peer refresh time,50[ms]
M/S refresh time,50[ms]
Slave T.O. detect reg.,No Use
Cooperation with PCs OK,No Use

Setup station parameters
No, Com kind, MAC ID, Mes ID, I address, I bytes, O address, O bytes, Bit rev, Byte rev, Time of T.
0, D. ST Status Info
/01, Poll, /02, --, FW000-FW008, /012, FW020-FW021, /004, --, Enable, 400, --,
/02, Poll, --, --, --, --, --, --, --, --, --, --,
/03, Poll, --, --, --, --, --, --, --, --, --, --,
/04, Poll, /03, --, FW100-FW103, /008, FW108-FW10B, /008, Enable, Enable, 400, --,

Setup data format conversion of D. STATION
No, Module, Input address, Output address, Assignment data area,
```

### 4.17 Installing and Starting Up the System

#### 4.17.1 Installing the system

##### (1) Installing the S10mini D.NET system

To install the S10mini D.NET in your operating system, open the DISK1 folder on the S10mini D.NET's system CD and double-click "setup.exe" in the folder to run the setup program. When it has been installed, create a shortcut icon on the desktop if necessary. The S10mini D.NET's window will not open automatically at that time.

Click the  button and choose [(All) Programs] - [Hitachi S10] - [D.NET SYSTEM] - [D.NET SYSTEM] from the [Start] menu on the Windows® screen. Click and hold the right mouse button on the [D.NET SYSTEM] and move the pointer to the desktop. Then, choose [Copy Here] from the pop-up menu.

#### **NOTICE**

Before installing the D.NET, be sure to exit all the currently open Windows® programs. Do not forget to exit anti-virus software and other memory-resident programs. If you try to install the D.NET without exiting such programs, an error may occur during the installation. In this case, first uninstall the D.NET as directed in "4.17.2 Uninstalling the system," exit all the Windows® programs, and then try it again.

##### (2) Installing the S10V D.NET system

To install the S10V D.NET in your operating system, open the DISK1 folder on the S10V D.NET's system CD and double-click "setup.exe" in the folder to run the setup program. When it has been installed, create a shortcut icon on the desktop if necessary. The S10V D.NET's window will not open automatically at that time.

Click the  button and choose [(All) Programs] - [Hitachi S10V] - [S10V D.NET SYSTEM] - [S10V D.NET SYSTEM] from the [Start] menu on the Windows® screen. Click and hold the right mouse button on the [S10V D.NET SYSTEM] and move the pointer to the desktop. Then, choose [Copy Here] from the pop-up menu.

**<Notes on installing in Windows® 7 (32-bit)>**

Installing the S10V D.NET system in Windows® 7 (32-bit) operating system requires prior logging onto the operating system with an appropriate Administrator account, which is the Administrator account first created in the initial condition of your personal computer. When you have so logged on, you can then double-click “setup.exe” that is stored in the DISK 1 folder on the S10V D.NET System CD. When “setup.exe” is started, the dialog box as shown below will appear. Click the  button to continue the execution of the setup program.

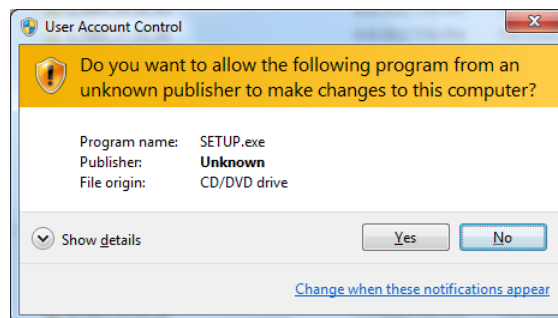

The S10V D.NET system cannot be installed on a per-user basis. To install the S10V D.NET system successfully, the user must first log onto the operating system with an appropriate Administrator account, which is the Administrator account first created in the initial condition of your personal computer. The S10V D.NET system may not be installed properly in any of the following cases: 1) administrator permission is acquired by using User Account Control(\*) with a standard user account and 2) logon is made with an Administrator account that has been created using User Account Control with a standard user account. If you make a logon with a user account that is different from the one you have used for the installation of the S10V D.NET system, the installed program may be missing from the program menu displayed. In this case, you should perform the following series of steps: 1) make a logon again with the Administrator account first created in the initial condition of your personal computer; 2) uninstall the installed program; and 3) install the program again. When you want to create a new account, be sure to make a logon with an Administrator account. Do not use User Account Control at that time.

(\*) User Account Control is a Microsoft Windows feature that temporarily grants administrative rights to standard user accounts.

A message reporting a read-only file detected may be displayed during the reinstallation of the S10V D.NET system. In this case, click the  button to set off overwriting.



### **NOTICE**

- The S10V base system is required for the S10V D.NET to run normally. If the base system is not installed, install it. Without the base system, you cannot install the S10V D.NET.
- Before installing the S10V D.NET, be sure to exit all the currently open Windows® programs. Do not forget to exit anti-virus software and other memory-resident programs. If you install the S10V D.NET without exiting such programs, an error may occur during use. In this case, first uninstall the S10V D.NET as directed in “4.17.2 Uninstalling the system,” exit all the Windows® programs, and then install the S10V D.NET again.

#### 4.17.2 Uninstalling the system

The existing D.NET system needs to be uninstalled when, for instance, you want to upgrade it. The procedure required for uninstalling it is as follows:

(1) Uninstalling from Windows® 2000

Click on  button on your Windows desktop and choose [Settings] - [Control Panel]. When the Control Panel opens, double-click on [Add/Remove Programs]. Then, choose “D.NET SYSTEM” (for S10mini controllers) or “S10V D.NET SYSTEM” (for S10V controllers) in the [Change or Remove Programs] tab and click the  button. When the [Confirm File Deletion] dialog box appears, click the  button.

(2) Uninstalling from Windows® XP

Click on  button on your Windows desktop and choose ([Settings] - ) [Control Panel]. When the Control Panel opens, double-click on [Add/Remove Programs]. Then, choose “D.NET SYSTEM” (for S10mini controllers) or “S10V D.NET SYSTEM” (for S10V controllers) in the [Change or Remove Programs] tab and click the  button. When the [Confirm File Deletion] dialog box appears, click the  button.

(3) Uninstalling from Windows® 7 (32-bit) -- for S10V controllers only

Click on  button on your Windows desktop and choose [Control Panel]. When the Control Panel opens, click [Programs and features]. Then, select “S10V D.NET SYSTEM” and click  button. When the [Confirm File Deletion] dialog box appears, click the  button.

### **NOTICE**

If Windows® presents the “Remove Shared File?” dialog box during the uninstall process, click the  button to retain the shared file.

### 4.17.3 Starting up the system

For information on how to start up the D.NET system, see “4.2.3 Starting up the D.NET system.”

### 4.17.4 Shutting down the system

To exit the D.NET system, click the  or  button in the channel selection window (for the S10mini) or module/channel selection window (for the S10V).

(For the S10mini)



Figure 4-118 Channel Selection Window

(For the S10V)

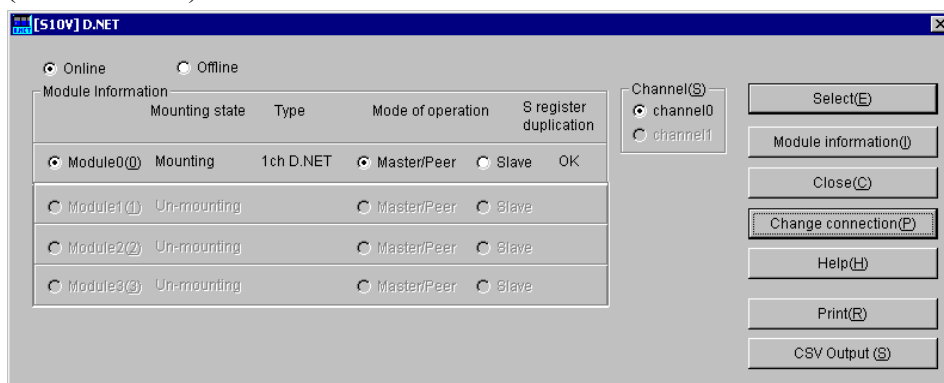

Figure 4-119 Module/Channel Selection Window

**This Page Intentionally Left Blank**

# 5 PROGRAMMING

5.1 Software Configuration of the D.NET System

This section gives an outline of the software configuration of the D.NET system.

As shown below, the communication control program is a ROM program and need not be loaded into the system.

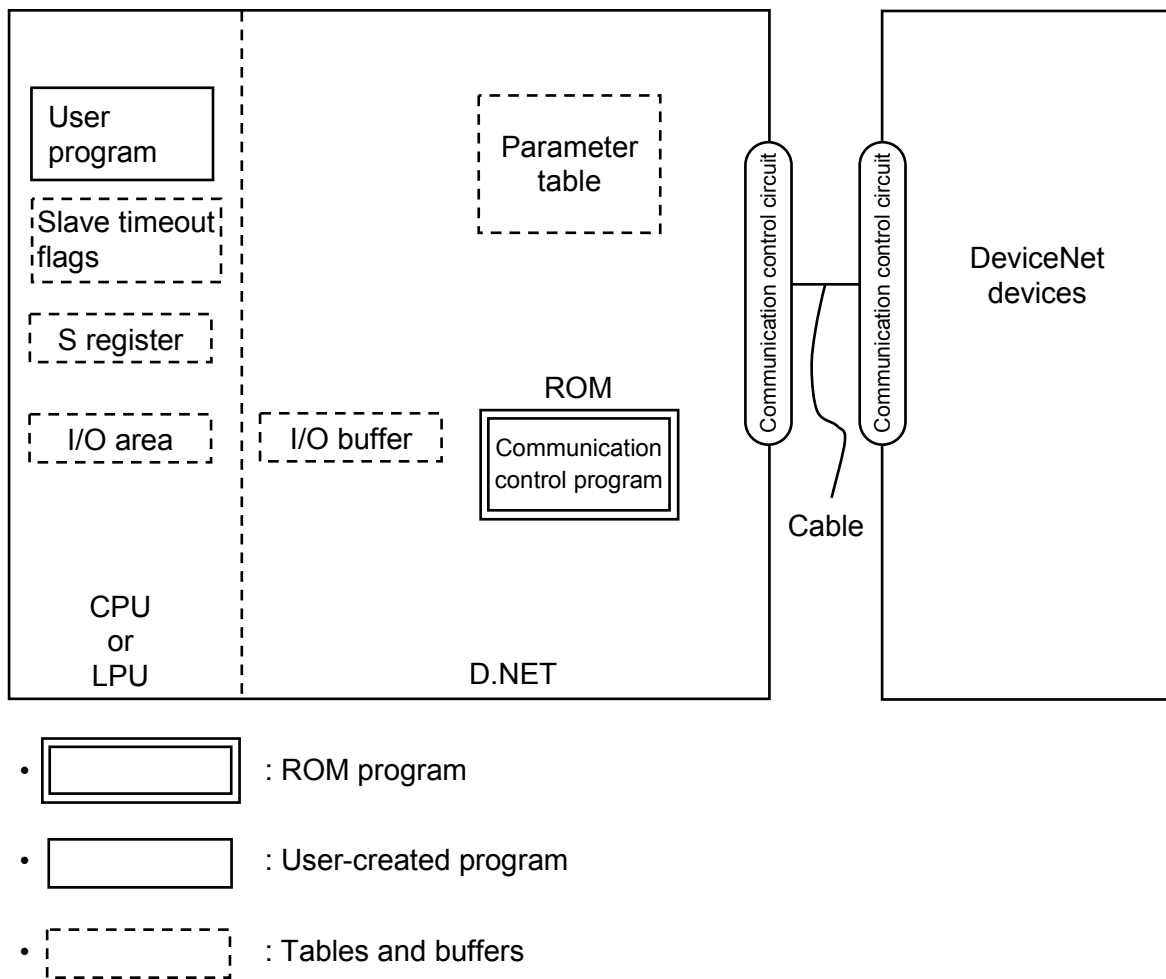
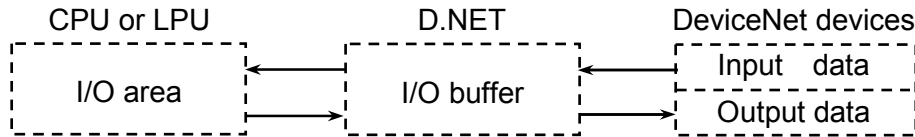

Figure 5-1 Software Configuration of the D.NET System

- Communication control program

The major function of this program is as shown below.

- The communication control program performs communications with DeviceNet devices.



### NOTICE

In this configuration, data is transferred word by word between the I/O area in the CPU or LPU and the I/O buffer in the D.NET system. Therefore, the unit of data transfer that can assure the simultaneousness of data is the word.

However, to assure the simultaneousness of data in the whole configuration, including DeviceNet devices, the DeviceNet devices themselves must also ensure the simultaneousness of data.

- Slave timeout flags and S-register

These registers are accessed by the communication control program when it sets data transmission/reception information and error information in them. The user program handles errors according to these pieces of information.

- I/O area

Below are listed the memory areas that can be used as the I/O area for data communication.

Table 5-1 Memory Areas Usable as the I/O Area

Name	Range of symbols	Number of points	Remarks
External input	XW000(X000) – XWFF0(XFFF)	256 words (4,096 points)	
External output	YW000(Y000) – YWFF0(YFFF)	256 words (4,096 points)	
Internal register	RW000(R000) – RWFF0(RFFF)	256 words (4,096 points)	
Global link register	GW000(G000) – GWFF0(GFFF)	256 words (4,096 points)	
Transfer register	JW000(J000) – JWFF0(JFFF)	256 words (4,096 points)	
Receive register	QW000(Q000) – QWFF0(QFFF)	256 words (4,096 points)	
Event register	EW400(E400) – EWFF0(EFFF)	192 words (3,072 points)	
Extension internal register	MW000(M000) – MWFF0(MFFF)	256 words (4,096 points)	
Function work register	FW000 – FWBFF	3,072 words	
Function data register	DW000 – DWFFF	4,096 words	
Extension memory	/100000 – /4FFFFFF	4 MB	In the S10V, this area is not available.
Work register	LBW0000(LB0000) – LBWFFF0(LBFFFF)	4,096 words (65,536 points)	In the S10mini, this area is not available.
Word work register	LWW0000 – LWWFFFF	65,536 words	In the S10mini, this area is not available.
	LXW0000 – LXW3FFF	16,384 words	In the S10mini, this area is not available.

## 5.2 Slave Timeout Flags

Slave timeout flags are set to report the occurrence of a reception timeout for the MAC ID of a specific slave device during master-slave communication. These flags can be referenced from ladder programs.

To use slave timeout flags, select slave timeout detection registers from the memory areas shown below and register them via the D.NET system (see “4 OPERATION”). The registered slave timeout flags are internally arranged as shown below.

The following memory areas can be registered as slave timeout detection registers:

<For S10mini series>

XW000-XWFF0, YW000-YWFF0, JW000-JWFF0, QW000-QWFF0, GW000-GWFF0, RW000-RWFF0, EW400-EWFF0, MW000-MWFF0 (8 areas in total)

<For S10V series>

XW000-XWFF0, YW000-YWFF0, JW000-JWFF0, QW000-QWFF0, GW000-GWFF0, RW000-RWFF0, EW400-EWFF0, MW000-MWFF0, LBW000-LBWFFF0 (9 areas in total)

A set of slave timeout flags is registered for each module and requires a size of 64 points in sequence.

For example, if the register X500 is registered as the first register for a set of slave timeout flags, then the memory area ranging from X500 to X53F is exclusively used as the slave timeout flags, as shown below.

	X5□0															X5□F
XW500	0	1	2	3	4	5	6	7	8	9	A	B	C	D	E	F
XW510	10	11	12	13	14	15	16	17	18	19	1A	1B	1C	1D	1E	1F
XW520	20	21	22	23	24	25	26	27	28	29	2A	2B	2C	2D	2E	2F
XW530	30	31	32	33	34	35	36	37	38	39	3A	3B	3C	3D	3E	3F

Corresponding to the MAC ID of a slave  
(0: Normal, 1: Reception timeout occurred)

The used/unused status of each slave timeout flag can be specified from a setup window only when the master-peer mode is selected. This feature cannot be used when the slave mode is selected.

**NOTICE**

Each slave timeout flag is set (= “1”) when no data is received from the slave device within a fixed time period. However, this is not the case when data cannot be transmitted normally due to the occurrence of a CAN transmission timeout or bus-off condition. The reason for this is that reception monitoring always starts upon the completion of a normal transmission. The occurrence of a CAN transmission timeout and bus-off condition can be confirmed by accessing the S-register described in “5.3 S-Register.”

5.3 S-Register

The S-register is a register to store error information for errors that have occurred in modules. It can be referenced from ladder programs. An error bit in the S-register is set to “1” (ON) when an error of the corresponding error type occurs in any one of the DeviceNet devices connected to the modules.

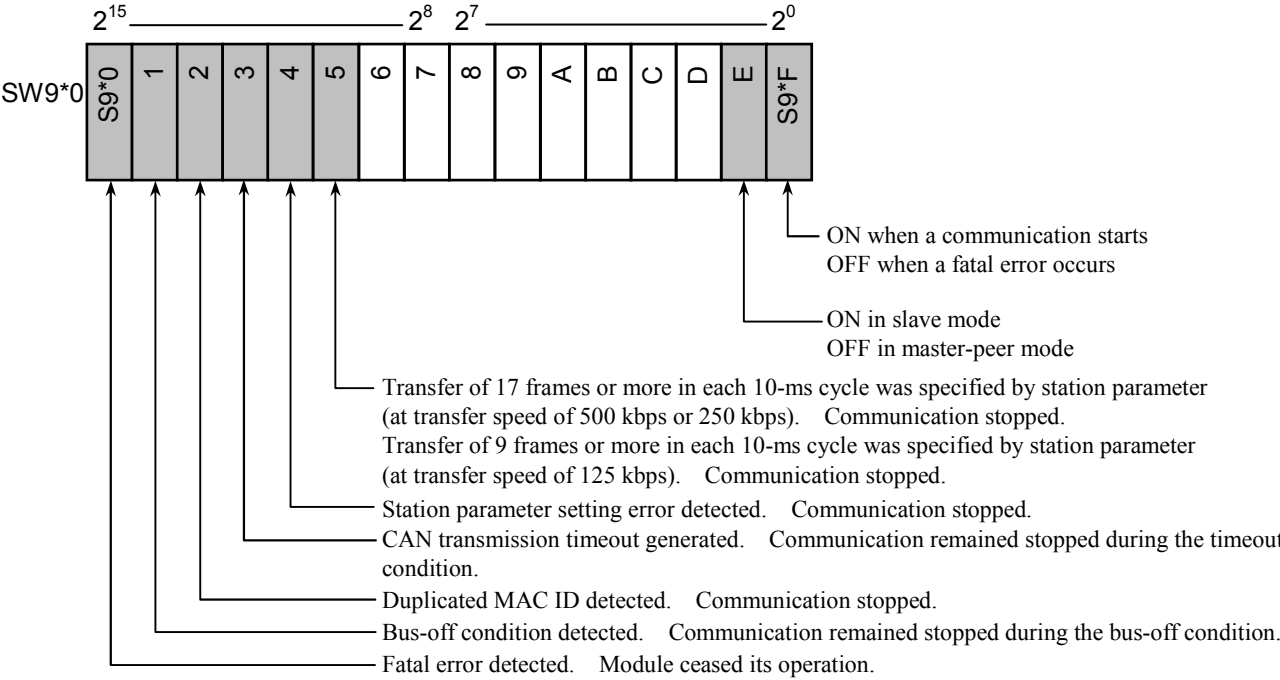

- SW9\*0 { Set value of MODU No. setting switch = 0: SW980 (Channel-0 module)
- Set value-of MODU No. setting switch = 1: SW990 (Channel-1 module)
- Set value of MODU No. setting switch = 2: SW9A0 (Channel-2 module)
- Set value of MODU No. setting switch = 3: SW9B0 (Channel-3 module)

**NOTICE**

The bus-off and CAN transmission timeout error bits are set to “0” (OFF) when the corresponding error conditions are cleared. Therefore, if the communication cable is damaged or the communication connector is connected incompletely, these bits may be set and reset repeatedly. Keep this in mind when referencing this register from a ladder program.



5.4 Communication Processing Time

(1) Refresh time and transmission cycle

Data transmission/reception (communication in master or slave mode) and peer transmission with slave devices are performed in cycles of the set refresh time.

Unlike the case of the LQE070, both the refresh operation and transmission operation are performed in synchronization with each other, as shown in the figure below.

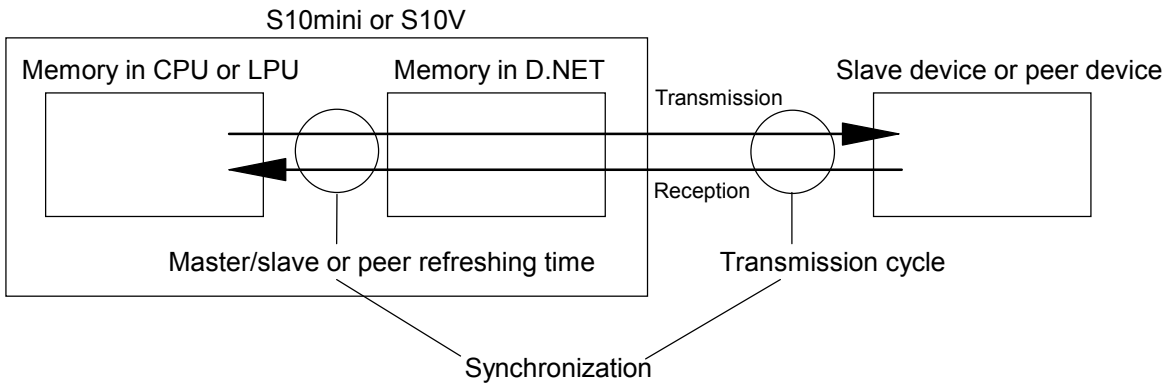

Accordingly, if, for example, the master/slave refresh time or peer refresh time is set to 30 ms, the transmission cycle used is also 30 ms. As a result, the maximum communication delay time is 30 ms when data is transmitted from the CPU or LPU memory to a slave device or peer device.

## (2) Guide to setting the refresh time

To set the refresh time, first calculate the total communication processing time by using the formula shown below, which calculates D.NET communication processing time. Then, set the refresh time to a value larger than the calculated total.

Communication processing time [ms]

= Sum total of all of processing time per slave, peer transmission time per message ID, peer reception time per message ID, and through-network peer frame transmission time

Processing time per slave [ms] =  $(F_s + F_r) \times V_t + 0.015 \times N_s + 0.013 \times N_r + 0.12$

Peer transmission time per message ID [ms] =  $0.015 \times N_s + 0.1$

Peer reception time per message ID [ms] =  $0.013 \times N_r + 0.02$

Through-network peer frame transmission time [ms] =  $F_a \times V_t$

Ns: Number of output bytes

Nr: Number of input bytes

Vt: Transmission time of a frame (depending on the transfer speed):

= 0.222 at 500 kbps; = 0.444 at 250 kbps; = 0.888 at 125 kbps.

Fs: Number of send frames (depending on the value of Ns):

= 1 if the value of Ns is in the range 0 to 8.

=  $N_s \div 7$  (rounded up to the nearest integer) if the value of Ns is in the range 9 to 256.

Fr: Number of receive frames (depending on the value of Nr):

= 1 if the value of Nr is in the range 0 to 8.

=  $N_r \div 7$  (rounded up to the nearest integer) if the value of Nr is in the range 9 to 256.

Fa: Total number of peer communication frames to flow through the network

As shown, the processing time per slave device, peer transmission time per message ID, and peer reception time per message ID are functions of the number(s) of input bytes and/or output bytes. Accordingly, if multiple slave devices each having the different number of input/output bytes are connected to the D.NET module, the communication processing time is the sum total of processing time per slave, peer transmission time per message ID, and peer reception time per message ID.

## 5 PROGRAMMING

Example: Finding the communication processing time:

The following is an example of finding the communication processing time at a given number of slave devices connected to the D.NET module, where each slave uses a value of 8 for both the number of input bytes and the number of output bytes and performs data transfer at a transfer speed of 500 kbps. The curve (a) below indicates that, given 40 such slave devices connected to it, the communication processing time is about 32 ms. In this case, the refresh time must be set to 32 ms or more.

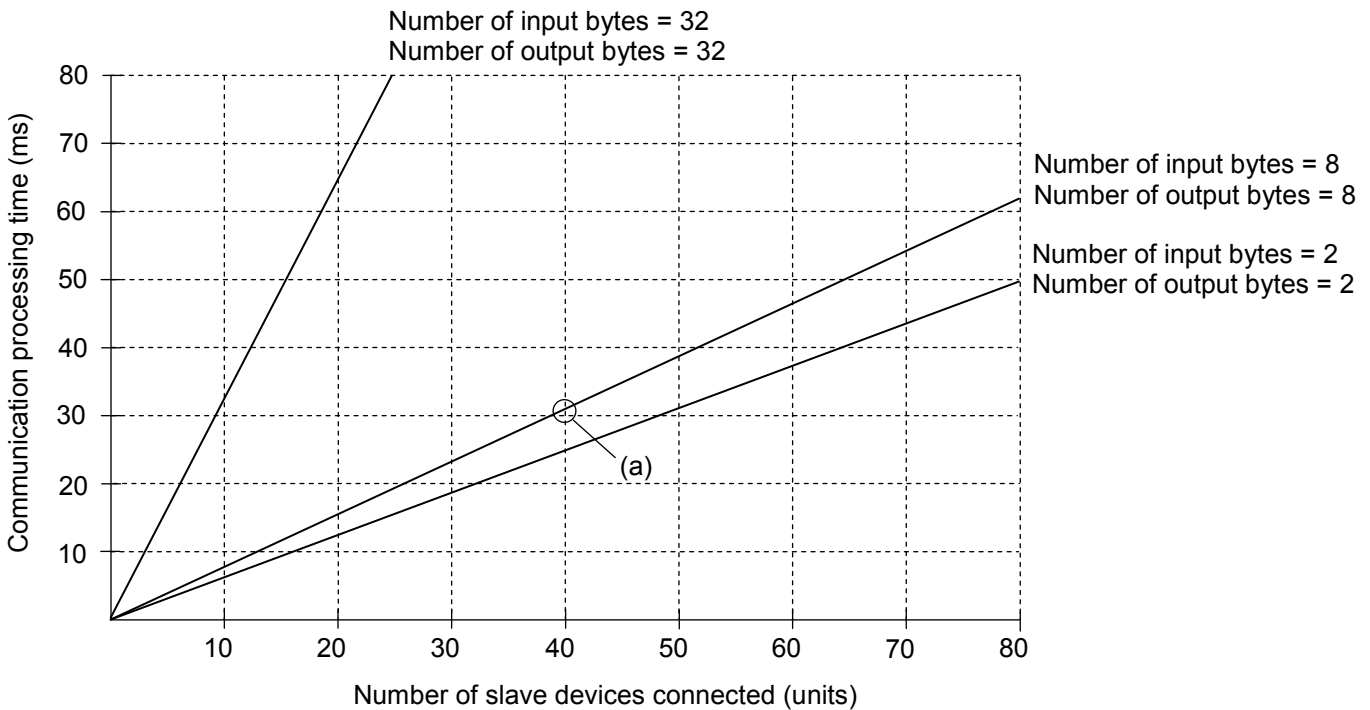

Figure 5-2 Finding the Communication Processing Time

### **NOTICE**

- The set value of the refresh time must satisfy the following conditions:  
The number of transmission frames per 10 ms is 16 or less (at transfer speed of 500 or 250 kbps).  
The number of transmission frames per 10 ms is 8 or less (at transfer speed of 125 kbps).  
 Number of transmission frames  
 (if the number of output bytes is 8 or less) = 1  
 (if the number of output bytes is 9 or more) = Number of output bytes ÷ 7  
 (rounded up to integer)
- Be sure to set the refresh time to the obtained communication processing time or more. If this requirement is not satisfied, the D.NET's communication capacity is exceeded, resulting in a delay of the transmission cycle.

## 5.5 CPU Load Ratio

When the LQE570/575 is used, the CPU load ratio increases less than 1%.

5.6 Response Time of the D.NET Module in Slave Mode

Figure 5-3 shows the relationship between the total number of input and output bytes and the internal processing time of the D.NET module starting at the reception of a polling request and ending at the transmission of a polling response. The internal processing time varies depending on the number of input and output bytes. The graph below should be used as a reference when designing a user system.

The response processing time (or internal processing time) graphed below does not include any amount of time to transmit frames to the communication line. This amount of time varies depending upon the line speed.

Point (a) in the graph below indicates that, when the total number of input and output bytes with the LQE570/575 is 128 bytes, the response time is about 1000  $\mu$ s.

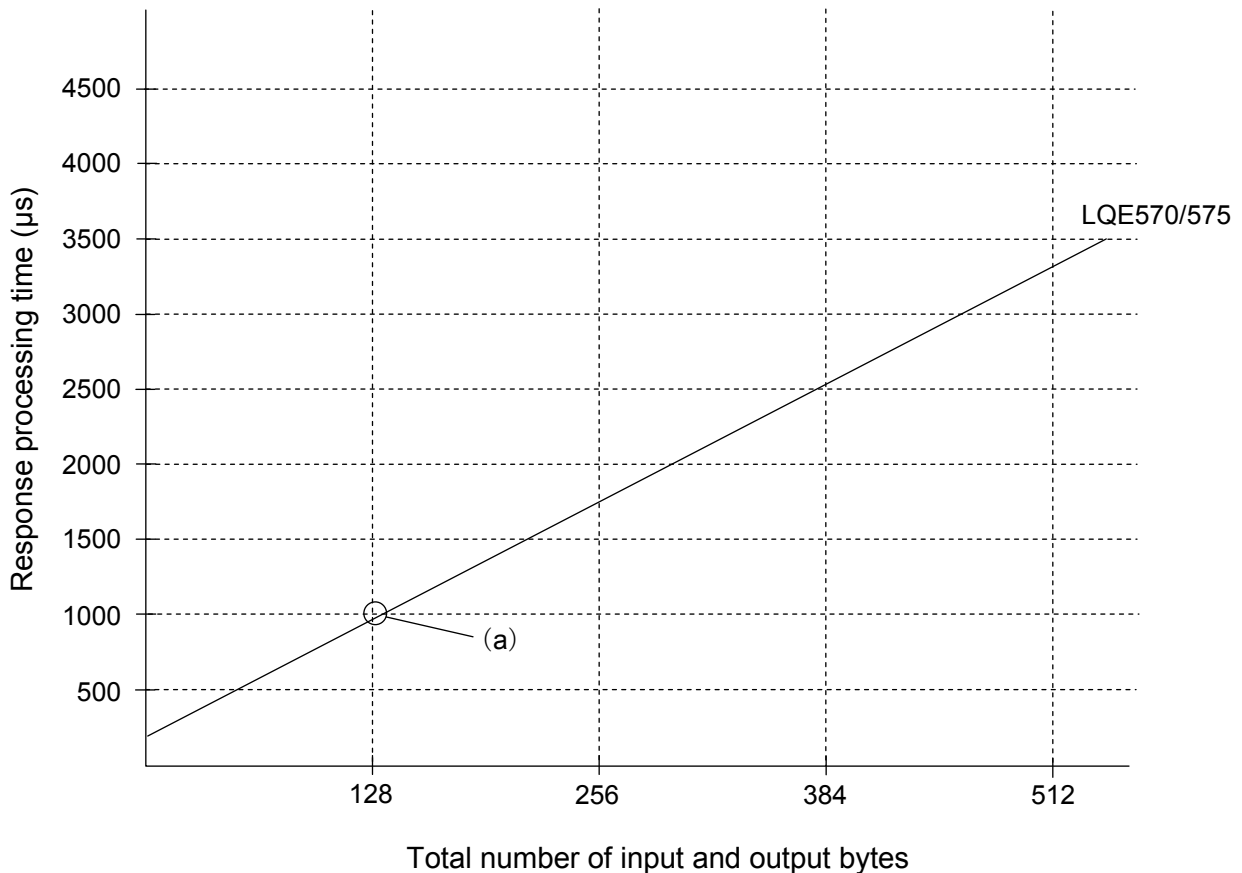

Figure 5-3 A Graphical Representation of the Response Time in Slave Mode

## 5.7 Parameter Settings Required for Other Company's DeviceNet Devices Connected

Where other company's DeviceNet I/O devices are connected to the D.NET module, you have to set the bit reversal mode and byte reversal mode according to the specifications of the slave I/O device (see Table 5-2). If the slave I/O device handles AI/AO data as long type, it requires swapping (of high-order and low-order words) at the application level. In addition, if the slave I/O device is a combination of AI/AO and DI/DO, it requires swapping (for both DI/DO and AI/AO) at the application level.

For details on the bit and byte arrangements used with given reversal mode settings, see "5.7.4 Data reversal modes."

Table 5-2 I/O Devices and Required Reversal Mode Settings

I/O devices	Bit reversal mode	Byte reversal mode	Swapping at application level
DI/DO (Hitachi) only	× (*1)	×	Not required
DI/DO (non-Hitachi) only	√	×	Not required
AI/AO (byte data)	×	×	Not required
AI/AO (word data) (*2)	×	√	Not required
AI/AO (long data)	×	√	High-order and low-order words must be swapped.
Combination of DI/DO and AI/AO	×	×	DI/DO and AI/AO data must be swapped separately.

√: Set to "enabled".

×: Set to "disabled".

(\*1) Note the following when using the D.NET module and D.Station as slave units:

- D.NET module  
If the bit reversal mode of the slave unit is disabled, also disable the bit reversal mode of the master unit. If it is enabled, also enable the master unit's.
- D.Station  
If the "FUNC2" rotary switch of the D.Station is set to "no bit swapping", disable the bit reversal mode. If it is set to "bit swapping", enable it. For more information about the D.Station, refer to the S10mini HARDWARE MANUAL, D.Station (manual number SME-1-119).

(\*2) This category of I/O devices includes analog pulse counter modules.

## 5 PROGRAMMING

### 5.7.1 Caution when disabling the bit reversal mode

If the bit reversal mode is disabled, care must be taken that the I/O numbers assigned to the bits of each word (16 bits) are reversed between the D.NET module and a non-Hitachi DeviceNet I/O device, such as DI/DO. However, this will not have any influence upon analog data and other numeric data.

CPU or LPU	D.NET	Non-Hitachi DeviceNet I/O device		
		8-point module (Module with 1 byte)	16-point module (Module with 2 bytes)	Analog module (1 channel with 2 bytes)
I/O number ↓ □000 □001 □002 □003 □004 □005 □006 □007 □008 □009 □00A □00B □00C □00D □00E □00F ↑ (□ : Register symbol)	↔	I/O number ↓ F E D C B A 9 8 7 6 5 4 3 2 1 0 ↑	I/O number ↓ F E D C B A 9 8 7 6 5 4 3 2 1 0 ↑	
	Reversed			
		The I/O numbers of the bits of each word used in the CPU or LPU are in the opposite order to those used in non-Hitachi DeviceNet I/O devices.		Numeric data will not be affected at all.

Because of the reversed I/O numbers, the input signal “0” of non-Hitachi DeviceNet I/O devices is represented as “□\*\*F” in S10mini and S10V ladder programs, where □ is a register symbol and \*\* is a register address.

5.7.2 Caution when enabling the bit reversal mode

If the bit reversal mode is enabled, the D.NET module internally reverses the order of the bits in each word before inputting and outputting the data. Therefore, you can transfer data between the D.NET module and a non-Hitachi DeviceNet I/O device (DI/DO) without paying attention to the order of the I/O numbers of the bits. However, this mode cannot be enabled for slave devices containing analog data or other numeric data, because it makes such data undefined if enabled.

CPU or LPU	D.NET	Non-Hitachi DeviceNet I/O device																																																																																																																																
		8-point module (Module with 1 byte)	16-point module (Module with 2 bytes)	Analog module (1 channel with 2 bytes)																																																																																																																														
<p>I/O number</p> <p>↓</p> <table style="border-collapse: collapse;"> <tr><td style="border: 1px solid black; padding: 2px;">□000</td><td style="border: 1px solid black; width: 20px; height: 20px;"></td><td rowspan="8" style="vertical-align: middle; padding-left: 5px;"><math>2^{15}</math> (MSB)</td></tr> <tr><td style="border: 1px solid black; padding: 2px;">□001</td><td style="border: 1px solid black; width: 20px; height: 20px;"></td></tr> <tr><td style="border: 1px solid black; padding: 2px;">□002</td><td style="border: 1px solid black; width: 20px; height: 20px;"></td></tr> <tr><td style="border: 1px solid black; padding: 2px;">□003</td><td style="border: 1px solid black; width: 20px; height: 20px;"></td></tr> <tr><td style="border: 1px solid black; padding: 2px;">□004</td><td style="border: 1px solid black; width: 20px; height: 20px;"></td></tr> <tr><td style="border: 1px solid black; padding: 2px;">□005</td><td style="border: 1px solid black; width: 20px; height: 20px;"></td></tr> <tr><td style="border: 1px solid black; padding: 2px;">□006</td><td style="border: 1px solid black; width: 20px; height: 20px;"></td></tr> <tr><td style="border: 1px solid black; padding: 2px;">□007</td><td style="border: 1px solid black; width: 20px; height: 20px;"></td></tr> <tr><td style="border: 1px solid black; padding: 2px;">□008</td><td style="border: 1px solid black; width: 20px; height: 20px;"></td><td rowspan="8" style="vertical-align: middle; padding-left: 5px;"><math>2^8</math> <math>2^7</math></td></tr> <tr><td style="border: 1px solid black; padding: 2px;">□009</td><td style="border: 1px solid black; width: 20px; height: 20px;"></td></tr> <tr><td style="border: 1px solid black; padding: 2px;">□00A</td><td style="border: 1px solid black; width: 20px; height: 20px;"></td></tr> <tr><td style="border: 1px solid black; padding: 2px;">□00B</td><td style="border: 1px solid black; width: 20px; height: 20px;"></td></tr> <tr><td style="border: 1px solid black; padding: 2px;">□00C</td><td style="border: 1px solid black; width: 20px; height: 20px;"></td></tr> <tr><td style="border: 1px solid black; padding: 2px;">□00D</td><td style="border: 1px solid black; width: 20px; height: 20px;"></td></tr> <tr><td style="border: 1px solid black; padding: 2px;">□00E</td><td style="border: 1px solid black; width: 20px; height: 20px;"></td></tr> <tr><td style="border: 1px solid black; padding: 2px;">□00F</td><td style="border: 1px solid black; width: 20px; height: 20px;"></td></tr> <tr><td colspan="2" style="text-align: right; padding-right: 5px;"><math>2^0</math> (LSB)</td></tr> </table> <p style="text-align: center;">↔</p>	□000		$2^{15}$ (MSB)	□001		□002		□003		□004		□005		□006		□007		□008		$2^8$ $2^7$	□009		□00A		□00B		□00C		□00D		□00E		□00F		$2^0$ (LSB)		<p>I/O number</p> <p>↓</p> <table style="border-collapse: collapse;"> <tr><td style="border: 1px solid black; padding: 2px;">0</td><td style="border: 1px solid black; width: 20px; height: 20px;"></td><td rowspan="8" style="vertical-align: middle; padding-left: 5px;"><math>2^{15}</math> (MSB)</td></tr> <tr><td style="border: 1px solid black; padding: 2px;">1</td><td style="border: 1px solid black; width: 20px; height: 20px;"></td></tr> <tr><td style="border: 1px solid black; padding: 2px;">2</td><td style="border: 1px solid black; width: 20px; height: 20px;"></td></tr> <tr><td style="border: 1px solid black; padding: 2px;">3</td><td style="border: 1px solid black; width: 20px; height: 20px;"></td></tr> <tr><td style="border: 1px solid black; padding: 2px;">4</td><td style="border: 1px solid black; width: 20px; height: 20px;"></td></tr> <tr><td style="border: 1px solid black; padding: 2px;">5</td><td style="border: 1px solid black; width: 20px; height: 20px;"></td></tr> <tr><td style="border: 1px solid black; padding: 2px;">6</td><td style="border: 1px solid black; width: 20px; height: 20px;"></td></tr> <tr><td style="border: 1px solid black; padding: 2px;">7</td><td style="border: 1px solid black; width: 20px; height: 20px;"></td></tr> <tr><td style="border: 1px solid black; padding: 2px;">8</td><td style="border: 1px solid black; width: 20px; height: 20px;"></td><td rowspan="8" style="vertical-align: middle; padding-left: 5px;"><math>2^8</math> <math>2^7</math> (MSB)</td></tr> <tr><td style="border: 1px solid black; padding: 2px;">9</td><td style="border: 1px solid black; width: 20px; height: 20px;"></td></tr> <tr><td style="border: 1px solid black; padding: 2px;">A</td><td style="border: 1px solid black; width: 20px; height: 20px;"></td></tr> <tr><td style="border: 1px solid black; padding: 2px;">B</td><td style="border: 1px solid black; width: 20px; height: 20px;"></td></tr> <tr><td style="border: 1px solid black; padding: 2px;">C</td><td style="border: 1px solid black; width: 20px; height: 20px;"></td></tr> <tr><td style="border: 1px solid black; padding: 2px;">D</td><td style="border: 1px solid black; width: 20px; height: 20px;"></td></tr> <tr><td style="border: 1px solid black; padding: 2px;">E</td><td style="border: 1px solid black; width: 20px; height: 20px;"></td></tr> <tr><td style="border: 1px solid black; padding: 2px;">F</td><td style="border: 1px solid black; width: 20px; height: 20px;"></td></tr> <tr><td colspan="2" style="text-align: right; padding-right: 5px;"><math>2^0</math> (LSB)</td></tr> </table> <p style="text-align: center;">↑</p>	0		$2^{15}$ (MSB)	1		2		3		4		5		6		7		8		$2^8$ $2^7$ (MSB)	9		A		B		C		D		E		F		$2^0$ (LSB)		<p>I/O number</p> <p>↓</p> <table style="border-collapse: collapse;"> <tr><td style="border: 1px solid black; padding: 2px;">0</td><td style="border: 1px solid black; width: 20px; height: 20px;"></td><td rowspan="8" style="vertical-align: middle; padding-left: 5px;"><math>2^{15}</math> (MSB)</td></tr> <tr><td style="border: 1px solid black; padding: 2px;">1</td><td style="border: 1px solid black; width: 20px; height: 20px;"></td></tr> <tr><td style="border: 1px solid black; padding: 2px;">2</td><td style="border: 1px solid black; width: 20px; height: 20px;"></td></tr> <tr><td style="border: 1px solid black; padding: 2px;">3</td><td style="border: 1px solid black; width: 20px; height: 20px;"></td></tr> <tr><td style="border: 1px solid black; padding: 2px;">4</td><td style="border: 1px solid black; width: 20px; height: 20px;"></td></tr> <tr><td style="border: 1px solid black; padding: 2px;">5</td><td style="border: 1px solid black; width: 20px; height: 20px;"></td></tr> <tr><td style="border: 1px solid black; padding: 2px;">6</td><td style="border: 1px solid black; width: 20px; height: 20px;"></td></tr> <tr><td style="border: 1px solid black; padding: 2px;">7</td><td style="border: 1px solid black; width: 20px; height: 20px;"></td></tr> <tr><td style="border: 1px solid black; padding: 2px;">8</td><td style="border: 1px solid black; width: 20px; height: 20px;"></td><td rowspan="8" style="vertical-align: middle; padding-left: 5px;"><math>2^8</math> <math>2^7</math></td></tr> <tr><td style="border: 1px solid black; padding: 2px;">9</td><td style="border: 1px solid black; width: 20px; height: 20px;"></td></tr> <tr><td style="border: 1px solid black; padding: 2px;">A</td><td style="border: 1px solid black; width: 20px; height: 20px;"></td></tr> <tr><td style="border: 1px solid black; padding: 2px;">B</td><td style="border: 1px solid black; width: 20px; height: 20px;"></td></tr> <tr><td style="border: 1px solid black; padding: 2px;">C</td><td style="border: 1px solid black; width: 20px; height: 20px;"></td></tr> <tr><td style="border: 1px solid black; padding: 2px;">D</td><td style="border: 1px solid black; width: 20px; height: 20px;"></td></tr> <tr><td style="border: 1px solid black; padding: 2px;">E</td><td style="border: 1px solid black; width: 20px; height: 20px;"></td></tr> <tr><td style="border: 1px solid black; padding: 2px;">F</td><td style="border: 1px solid black; width: 20px; height: 20px;"></td></tr> <tr><td colspan="2" style="text-align: right; padding-right: 5px;"><math>2^0</math> (LSB)</td></tr> </table> <p style="text-align: center;">↑</p>	0		$2^{15}$ (MSB)	1		2		3		4		5		6		7		8		$2^8$ $2^7$	9		A		B		C		D		E		F		$2^0$ (LSB)		<table style="border-collapse: collapse; width: 100%;"> <tr><td style="border: 1px solid black; padding: 2px; width: 20px; height: 20px;"></td><td style="border: 1px solid black; width: 20px; height: 20px;"></td><td rowspan="8" style="vertical-align: middle; padding-left: 5px;"><math>2^{15}</math> (MSB)</td></tr> <tr><td style="border: 1px solid black; padding: 2px; width: 20px; height: 20px;"></td><td style="border: 1px solid black; width: 20px; height: 20px;"></td></tr> <tr><td style="border: 1px solid black; padding: 2px; width: 20px; height: 20px;"></td><td style="border: 1px solid black; width: 20px; height: 20px;"></td></tr> <tr><td style="border: 1px solid black; padding: 2px; width: 20px; height: 20px;"></td><td style="border: 1px solid black; width: 20px; height: 20px;"></td></tr> <tr><td style="border: 1px solid black; padding: 2px; width: 20px; height: 20px;"></td><td style="border: 1px solid black; width: 20px; height: 20px;"></td></tr> <tr><td style="border: 1px solid black; padding: 2px; width: 20px; height: 20px;"></td><td style="border: 1px solid black; width: 20px; height: 20px;"></td></tr> <tr><td style="border: 1px solid black; padding: 2px; width: 20px; height: 20px;"></td><td style="border: 1px solid black; width: 20px; height: 20px;"></td></tr> <tr><td style="border: 1px solid black; padding: 2px; width: 20px; height: 20px;"></td><td style="border: 1px solid black; width: 20px; height: 20px;"></td></tr> <tr><td colspan="2" style="text-align: right; padding-right: 5px;"><math>2^0</math> (LSB)</td></tr> </table>			$2^{15}$ (MSB)															$2^0$ (LSB)	
□000		$2^{15}$ (MSB)																																																																																																																																
□001																																																																																																																																		
□002																																																																																																																																		
□003																																																																																																																																		
□004																																																																																																																																		
□005																																																																																																																																		
□006																																																																																																																																		
□007																																																																																																																																		
□008		$2^8$ $2^7$																																																																																																																																
□009																																																																																																																																		
□00A																																																																																																																																		
□00B																																																																																																																																		
□00C																																																																																																																																		
□00D																																																																																																																																		
□00E																																																																																																																																		
□00F																																																																																																																																		
$2^0$ (LSB)																																																																																																																																		
0		$2^{15}$ (MSB)																																																																																																																																
1																																																																																																																																		
2																																																																																																																																		
3																																																																																																																																		
4																																																																																																																																		
5																																																																																																																																		
6																																																																																																																																		
7																																																																																																																																		
8		$2^8$ $2^7$ (MSB)																																																																																																																																
9																																																																																																																																		
A																																																																																																																																		
B																																																																																																																																		
C																																																																																																																																		
D																																																																																																																																		
E																																																																																																																																		
F																																																																																																																																		
$2^0$ (LSB)																																																																																																																																		
0		$2^{15}$ (MSB)																																																																																																																																
1																																																																																																																																		
2																																																																																																																																		
3																																																																																																																																		
4																																																																																																																																		
5																																																																																																																																		
6																																																																																																																																		
7																																																																																																																																		
8		$2^8$ $2^7$																																																																																																																																
9																																																																																																																																		
A																																																																																																																																		
B																																																																																																																																		
C																																																																																																																																		
D																																																																																																																																		
E																																																																																																																																		
F																																																																																																																																		
$2^0$ (LSB)																																																																																																																																		
		$2^{15}$ (MSB)																																																																																																																																
$2^0$ (LSB)																																																																																																																																		
Reversed																																																																																																																																		
(□ : Register symbol)		The I/O numbers of the bits of each word used in the CPU or LPU are in the same order as those used in non-Hitachi DeviceNet I/O devices.		Do not enable the bit reversal mode when processing numeric data.																																																																																																																														



**NOTICE**

- The bit reversal mode can only be enabled for individual slaves separately.
- When the D.NET module is connected to a slave device (e.g., AI/AO) that handles numeric data such as analog data, do not enable the bit reversal mode for that slave device. If it is enabled, the I/O data will become undefined.
- Similarly, do not enable the bit reversal mode for a slave device that handles both analog and digital data. If it is enabled, the I/O data will become undefined.
- In the LQE570/575, the byte reversal mode has been added as its new feature. Basically, use D.NET modules of these models, with the byte reversal mode enabled. Disable the mode (by deselection) only when reversing the byte order.

5.7.3 Handling analog data

(1) Bytes of analog data

To handle bytes of analog data, disable the byte reversal mode (by deselection).

(2) Words of analog data

To handle words of analog data, enable the byte reversal mode (by selection).

(3) Long or longer words of analog data

- Assurance of data simultaneousness

The D.NET module can assure the simultaneousness of input and output data only in units of words. It cannot assure the simultaneousness of long words (4 bytes long) or longer words of analog data.

- Endian

The DeviceNet message format is little-endian as specified in the DeviceNet standard, but the LPU internally uses the big-endian format. By using the bit conversion mode, you can handle digital data, such as DI/DO, without paying attention to the endian.

However, the bit conversion mode cannot be applied to analog data, such as AI/AO. Therefore, when handling long or longer words of analog data, you must perform data swapping as shown below.

Example: Data swapping for long (4-byte) words of data:

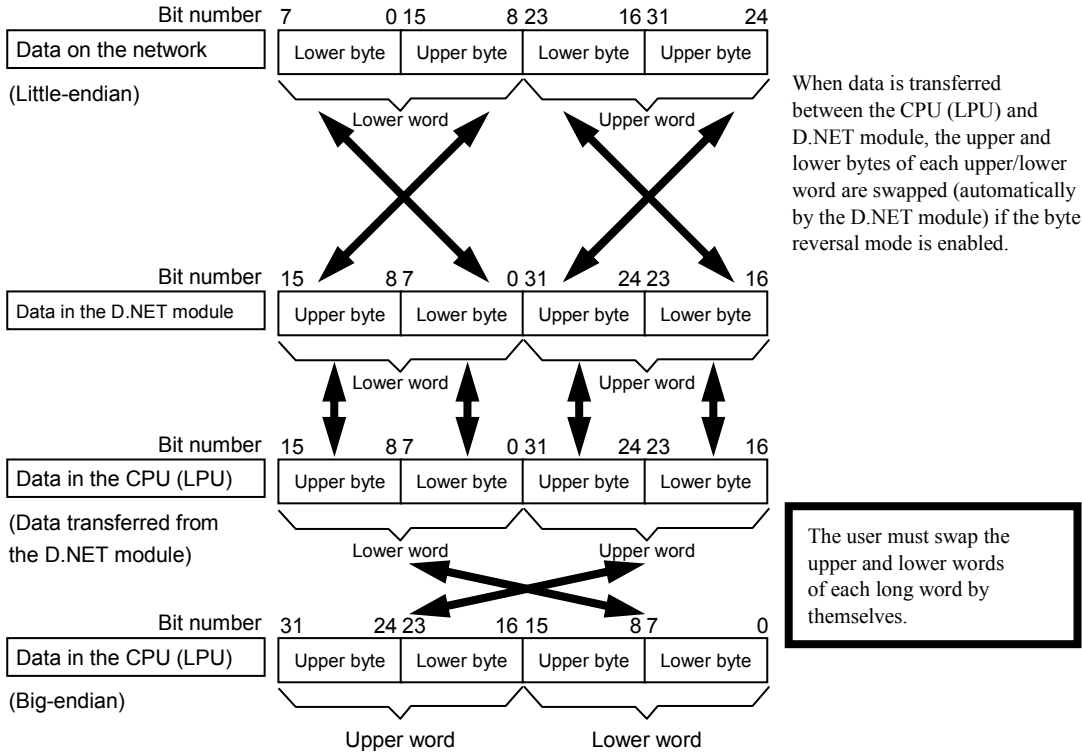

***NOTICE***

Data swapping by the user is required only when the data is made up of bytes or long or longer words. In this case, it is required regardless of the number of data bytes to be input or output. For example, if data is transferred to and from a 4-channel AI slave (1 word/ channel), the number of input bytes is 8, but no data swapping is required because the data is transferred in words.

5.7.4 Data reversal modes

The bit reversal and byte reversal modes can be set individually for each slave or peer device. Data conversion in each data reversal mode is described below.

- (1) No-conversion mode (both the bit reversal mode and byte reversal mode deselected)
 

In this mode, data in the S10mini CPU or S10V LPU is sent out to the DeviceNet line without any rearrangement (as shown below); or data from the DeviceNet line is transferred to the CPU or LPU without any rearrangement.

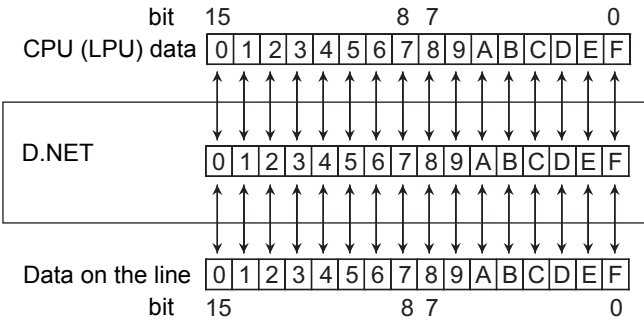

- (2) Bit conversion mode (only the bit reversal mode enabled)
 

In this mode, data in the S10mini CPU or S10V LPU has its bit order reversed for each word (as shown below) and is sent out to the DeviceNet line; or data from the DeviceNet line has its bit order reversed for each word and is transferred to the CPU or LPU.

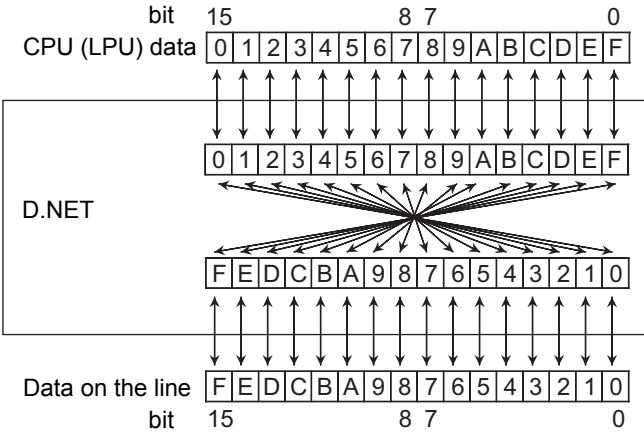

## 5 PROGRAMMING

### (3) Byte conversion mode (only the byte reversal mode enabled)

In this mode, data in the S10mini CPU or S10V LPU has its high-order and low-order bytes swapped for each word (as shown below) and is sent out to the DeviceNet line; or data from the DeviceNet line is processed by the same byte swapping for each word and is transferred to the CPU or LPU.

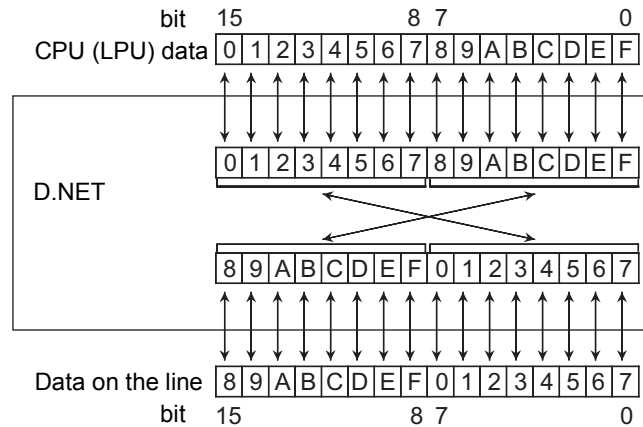

### (4) Bit and byte conversion mode (both the bit reversal mode and byte reversal mode enabled)

In this mode, data in the S10mini CPU or S10V LPU is processed by the conversions (2) and (3) described above for each word and is sent out to the DeviceNet line; or data from the DeviceNet line is processed by the same conversions for each word and is transferred to the CPU or LPU.

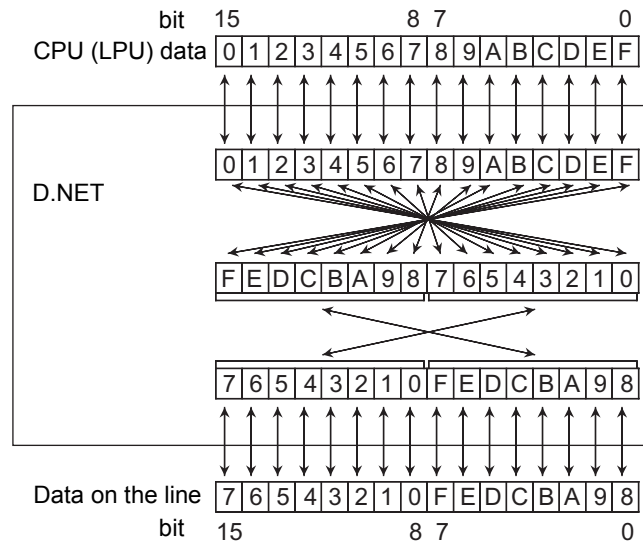

### **NOTICE**

- The bit reversal and byte reversal modes need to be enabled or disabled, depending on the data handling of application programs and the specifications of connected devices.
- Any area set for D.Station data format conversion is invalid in bit conversion mode, where no bit conversion is performed.

## 5.8 CPU or LPU Module Switch Settings and D.NET Module Operation

The operation of the D.NET module is controlled by the settings of both the ladder program operation (LADDER) switch and mode setting (MODE) switch of the CPU or LPU module, as shown below. For information on the settings of these switches, refer to the following manuals:

- S10mini HARDWARE MANUAL, CPU (manual number SME-1-100)
- S10V USER'S MANUAL, BASIC MODULES (manual number SVE-1-100)

(1) Operation when the non-linkage with the PCs OK signal is set

Ladder program operation setting (LADDER)	Mode setting (MODE)	D.NET module operation
STOP	NORM	Starts communication.
STOP	SIMU	Starts communication.
RUN	NORM	Starts communication.
RUN	SIMU	Stops communication.

The D.NET module also stops communication in the following cases:

S10mini:

- The CPU has gone down ("CPU DOWN" is displayed on the CPU's indicator).
- A 12 VDC to 24 VDC power supply is connected to the RI/O STOP contact input terminal on the CPU's terminal block.

S10V:

- The LPU has gone down (the ERR LED is lit).
- A 100 VAC or 100 VDC power supply is connected to the RI/O STOP contact input terminal on the LPU's terminal block.

(2) Operation when the linkage with the PCs OK signal is set

Ladder program operation setting (LADDER)	Mode setting (MODE)	D.NET module operation
STOP	NORM	Stops communication.
STOP	SIMU	Stops communication.
RUN	NORM	Starts communication.
RUN	SIMU	Stops communication.

The D.NET module also stops communication in the following cases:

S10mini:

- The CPU has gone down ("CPU DOWN" is displayed on the CPU's indicator).
- A 12 VDC to 24 VDC power supply is connected to the STOP/RUN contact input terminal on the CPU's terminal block.

S10V:

- The LPU has gone down (the ERR LED is lit).
- A 100 VAC or 100 VDC power supply is connected to the STOP/RUN contact input terminal on the LPU's terminal block.

**This Page Intentionally Left Blank**

# 6 INSTALLATION WORK ASSISTANCE



6.1 Installation Work Check List

No.	Category	Item	Check	Result of check
1	D.NET module	NA setting switch	Is the MAC ID set by the NA setting switch unique (different from any other MAC ID already set)?	
2		DR setting switch	Is the baud rate (transfer speed) set by the DR setting switch set equal to the transfer speed used in the system?	
3		MODU No. setting switch	Is the module number set by the MODU No. setting switch unique (among those of the other modules)?	
4	Cable	Cable length	Check the total cable length and total length of branch lines in the network. Are they within the limits imposed by the communication speed? (See “3.4 Wiring.”)	
5		Wiring environment	Are all the network cables fully away from power lines and other lines generating induction noise?	
6		Current capacity	Are the currents flowing through cables within tolerances? (See “3.4 Wiring.”)	
7		Cable specification	Do all the cables satisfy the specified requirements? (See “3.4 Wiring.”)	
8	Connector	Cable connection	Check the connection of cable wires identified by colors. Are they connected correctly? (See “3.4 Wiring.”)	
9		Shield-type connector	Are the connectors inserted completely and screwed firmly? Are the fastening screws driven straight into the holes?	
10		Open-type connector	Are the ferrules of the cables crimped and screwed with proper torque (0.5 to 0.6 N·m)?	
11			Is there not any double-wire connection? No two wires may be connected to a single terminal of the open-type connector.	
12	Terminating resistor	Connection	Are terminating resistors to terminate the CAN-H and CAN-L signal lines connected to both ends of the trunk line? They may not be connected to any other parts of the trunk line, except its farthest ends.	
13		Resistance error	Is the terminating resistor’s resistance $121 \Omega \pm 1\%$ (1/4 W or more)?	
14	Grounding	Grounding point	Is the shield of the communication cable grounded at only one point near the center of the network. Is the “V-” power line grounded via only one power supply in the network?	
15		Grounding environment	Does the grounding satisfy the Class D grounding requirements? Is it kept away from any power lines (for electric motors and the like)?	

# 7 MAINTENANCE

## 7 MAINTENANCE

---

### 7.1 Maintenance and Checks

#### 7.1.1 Periodic checks

Table 7-1 Periodic Checks

Item	Description of checks	Frequency
Unit cleaning	Shut off all electric power to the user system and clean the ventilation openings in the installed D.NET module's housing with a vacuum-cleaner.	Two or more times a year
Mechanism check	Check the installed D.NET module and communication cables for any loose mounting screws and damages. Tighten loose screws if any and replace damaged items if any.	Two or more times a year

### 7.1.2 Replacing or adding on the module

- What you should get in preparation

- ① Personal computer (with Hitachi's S10V D.NET System installed in it)
- ② RS-232C cable (or 10BASE-T cable if the communication module used is an ET.NET module)
- ③ New or add-on D.NET module (LQE570/575)
- ④ Copies of the parameter values for the module to be replaced. (These copies are prepared for use in cases where the parameters are not accessible for some reason.)
- ⑤ The above-mentioned ET.NET module is an optional module and, if it is mounted in place, may be selected as the type of communication module to be used. For more information, refer to Section 2.1, "Names and Functions of Each Part," and Section 3.2, "Mounting the Module," in the USER'S MANUAL, OPTION ET.NET (LQE520) (manual number SVE-1-103).

- Replacement procedure

- ① Write down, on a piece of paper, the current settings of the rotary switches that are, as shown below, accessible at the front side of the D.NET module to be replaced.
- ② Write down also the current settings of two switches, labeled LADDER (toggle switch) and T/M (rotary switch), respectively, that are, as shown below, accessible at the front side of the LPU module.

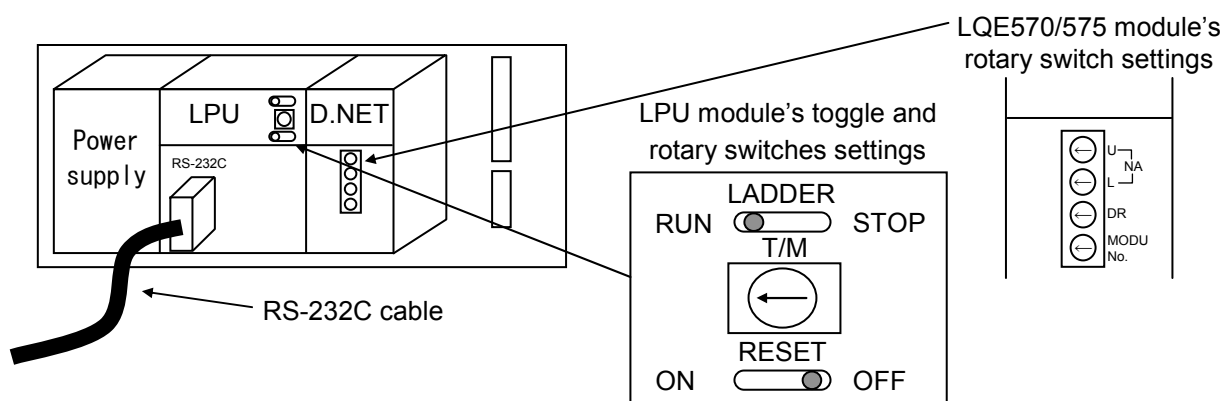

- ③ Connect the personal computer and the LPU module together with the RS-232C cable.
- ④ Start Hitachi's S10V D.NET System and save the set values of all the existing parameters by using its F/D function. (If the existing parameters are not accessible for some reason, use the copies of their set values [item ④] that were obtained in preparation.)
- ⑤ Set the LPU module's LADDER switch in STOP position and turn off the power supply of the controller unit.
- ⑥ Remove the connecting cables from the D.NET module to be replaced.

## 7 MAINTENANCE

---

- ⑦ Replace the existing D.NET module with the new one and set the new D.NET module's rotary switches in the same way as you wrote down in Step ①.
- ⑧ Turn on the power supply of the controller unit and send to the new D.NET module the set parameter values that you saved in Step ④ using the F/D function.
- ⑨ By using the F/D function, compare the set parameter values before and after you sent.

This comparison may reveal a discrepancy for the following memory areas:

- /E30004 thru E30006 for the D.NET module 0 mounted
- /E70004 thru E70006 for the D.NET module 1 mounted
- /EB0004 thru EB0006 for the D.NET module 2 mounted
- /EF0004 thru EF0006 for the D.NET module 3 mounted

However, if no discrepancies are found for any other area, the set parameter values (system information) for the new D.NET module may be considered as being identical between the saved file and memory.

- ⑩ Reset the LPU module by setting the RESET switch in ON position and then in OFF position at its front.
  - ⑪ Turn off the power supply of the controller unit.
  - ⑫ Remove the RS-232C cable from both the personal computer and LPU module, which were connected together in Step ③.
  - ⑬ Connect to the new D.NET module the connecting cables that you removed in Step ⑥.
  - ⑭ Set the LPU module's LADDER and T/M switches in the same way as you wrote down in Step ②.
  - ⑮ Turn on the power supply of the controller unit and check that the new D.NET module is running normally.
- Add-on procedure
    - ① Write down, on a piece of paper, the current settings of two switches, labeled LADDER (toggle switch) and T/M (rotary switch), respectively, that are accessible at the front side of the LPU module, the one that is installed in the controller unit in which you are adding on a D.NET module.
    - ② Ensure that your application system has been shut down. Then, set the LPU module's LADDER switch in STOP position and turn off the power supply of the controller unit.
    - ③ Mount the add-on D.NET module in place according to the instructions given under "3.2 Mounting the Module."
    - ④ Set the add-on D.NET module's rotary switches in such a way that a new setting will not duplicate with any of the current rotary switch settings of the existing D.NET module(s).

- ⑤ Connect the personal computer and the LPU module together with the RS-232C cable. Then, turn on the power supply of the controller unit and set parameters for the add-on D.NET module by using the S10V D.NET System.
- ⑥ Reset the LPU module by setting the RESET switch in ON position and then in OFF position at its front.
- ⑦ Turn off the power supply of the controller unit and connect the connecting cables to the add-on D.NET module.
- ⑧ Set the LPU module's LADDER and T/M switches in the same way as you wrote down in Step ①.
- ⑨ Remove the RS-232C cable from both the personal computer and LPU module, which were connected together in Step ⑤.
- ⑩ Turn on the power supply of the controller unit and check that the add-on D.NET module is running normally.

## 7.2 Troubleshooting

### 7.2.1 Procedure

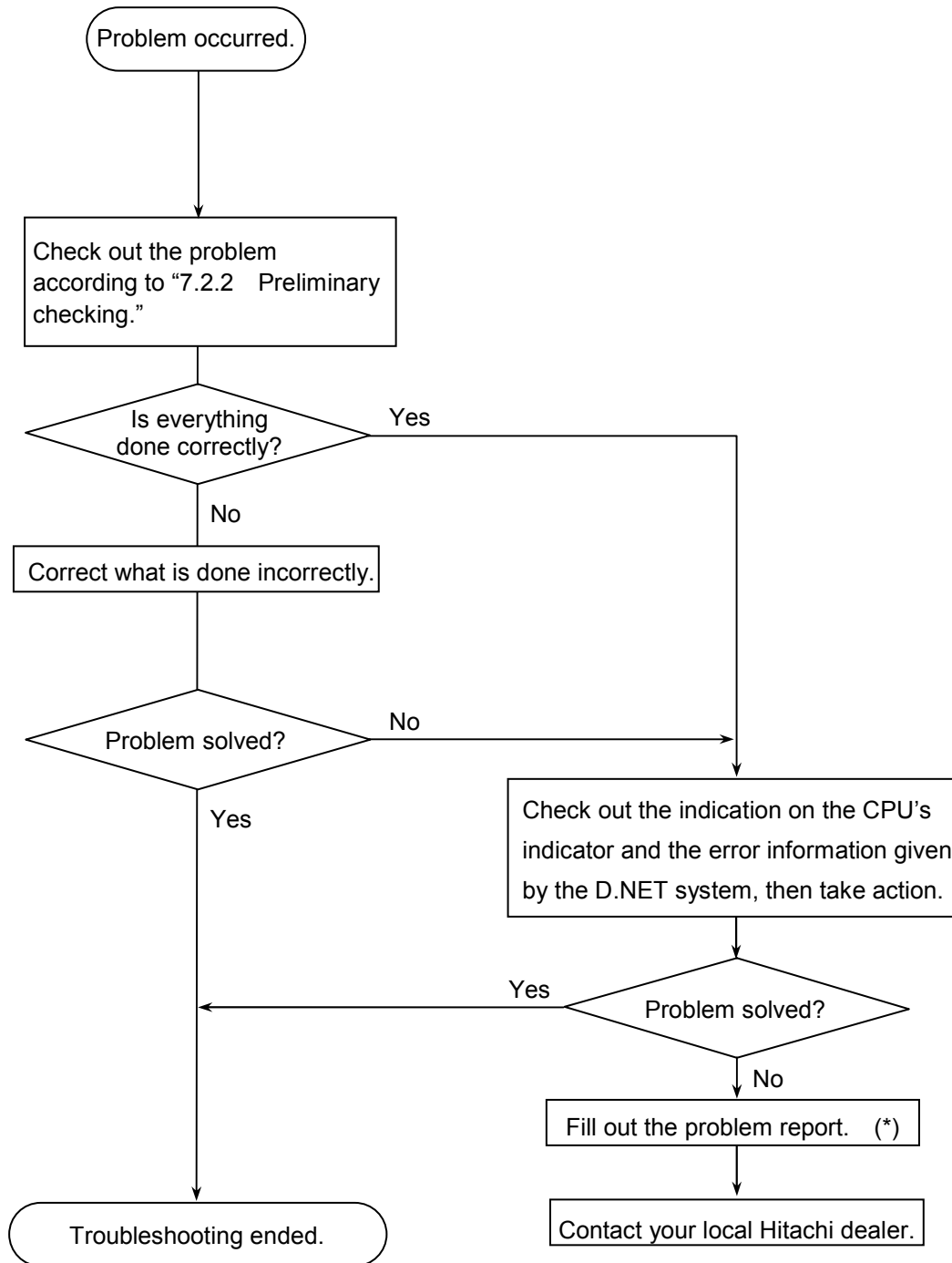

(\*) See "7.4 Problem Report."

### 7.2.2 Preliminary checking

(1) Factors that make the D.NET module unable to communicate

The D.NET module is unable to perform data communication in the cases described below. In these cases, take action according to the information given in the “Required action” column of Table 7-2.

Table 7-2 Factors that Make the D.NET Module Unable to Communicate

No.	Factor	Required action
1	The network has only one D.NET module installed in it. (The D.NET module requires an additional node for data communication.)	This is not a system fault. Connect an additional node to the network and power it up. Then, the D.NET module can start communication.
2	There are two or more nodes installed in the network, but they have different transfer speeds.	Set up all the nodes in the network so that they may have an identical transfer speed.
3	There are two or more nodes installed in the network, but the line load is too high for transmission. (This problem may occur when the MAC ID of the local node is lower in priority than those of the other distant nodes. The smaller the value of a MAC ID, the higher its priority is.)	Reduce the network load by lengthening the current transmission cycle of each node, reducing the number of the installed nodes, and/or the like.
4	No power is supplied to the network. The LQE570 does not need a network power supply, but the LQE575 and other manufacturer’s DeviceNet devices require a network power supply.	Connect a network power supply to the network.
5	A network power supply is connected to the network, but its capacity is too small.	Review the capacity of the network power supply. (See “3.4.5 Consideration on the location of a communication power supply.”)
6	The cable length used exceeds the maximum allowable cable length.	Review the cable length. (See “3.4.4 Restriction of cable lengths.”)
7	A terminating resistor is missing.	Install a terminating resistor in place. (See “3.4.3 Components.”)
8	The cable connection to the D.NET module is loose.	Check for any loosely connected connectors and connect them firmly.
9	The CAN-H or CAN-L wire of the connector cable is connected loosely.	Check for any loosely connected cable wires and connect them firmly.



## 7 MAINTENANCE

---

(2) Is the cable wiring done correctly?

Check the cables for any disconnection or poor connection.

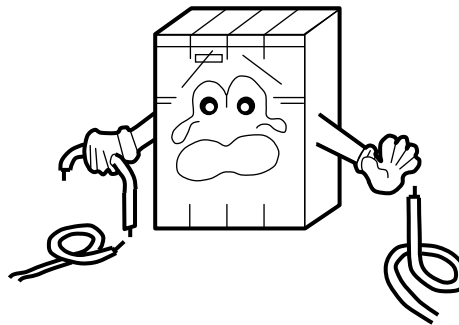

(3) Is the module mounted correctly?

- In the S10mini, check that all the modules are mounted in place with no empty slot between the CPU module and optional modules.
- Check that no mounting screws are loosened.

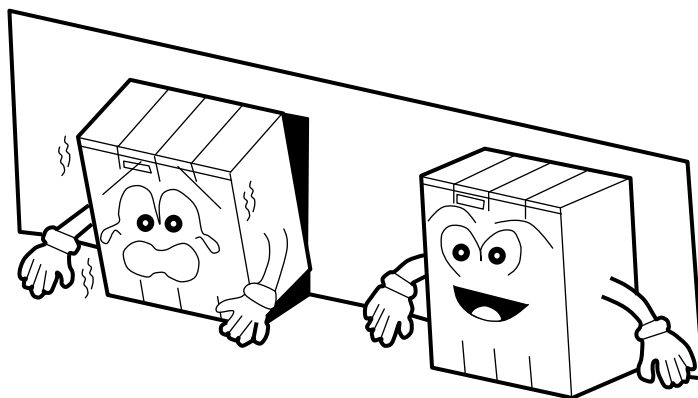

(4) Is the grounding done correctly?

- Do not ground the D.NET module at the same point as high-voltage equipment is grounded. They must be grounded at different grounding points.
- Perform grounding work conforming to the Class D grounding standard or higher.

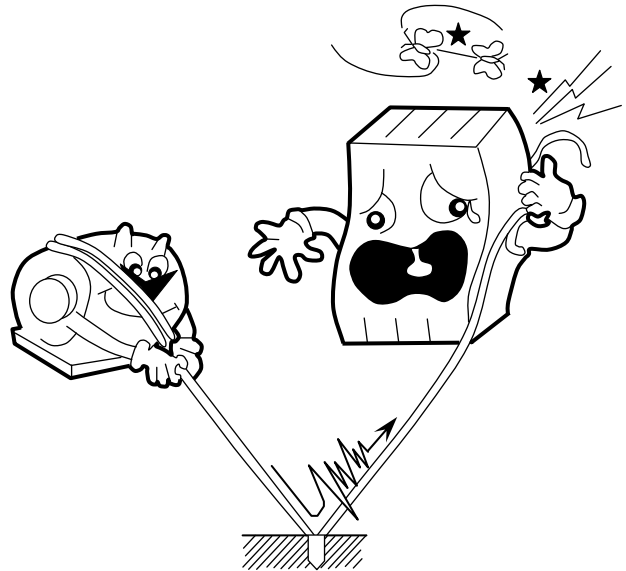

(5) Are the LG and FG separated?

- Be sure to ground the LG separately from the FG or vice versa, because without doing so power noise will enter the FG via the LG. Failure to observe this rule may result in an equipment malfunction.
- Ground the LG at the power supply.

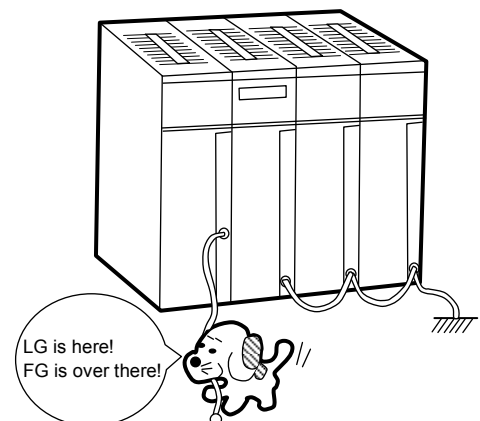

## 7.3 Errors and Remedial Actions

### 7.3.1 Indications on the CPU module's indicator

In the S10mini, when an event or error occurs, a message as shown in Table 7-3 is displayed on the 8-character indicator of the CPU module. The displayed message is classified by MODU No.

In the S10V, error information is collected but no error indication is given on the LPU module. Collected error information can be referenced from the S10V base system. For details, see “7.3.2 Error indications and required actions.”

Table 7-3 Indications on the CPU Module's Indicator in the S10mini

MODU No.	Indication	Meaning	Remedial action
0	DN0 @. @	The D.NET module numbered 0 has started up normally.	This is not an error.
	EXF0 PTY	A parity error occurred when the CPU read memory data from the D.NET module numbered 0.	Reset the CPU once. If the indication still appears, replace the D.NET module.
	DN0 □□□□	An error was detected in the D.NET module numbered 0.	See “7.3.2 Error indications and required actions.”
1	DN1 @. @	The D.NET module numbered 1 has started up normally.	This is not an error.
	EXF1 PTY	A parity error occurred when the CPU read memory data from the D.NET module numbered 1.	Reset the CPU once. If the indication still appears, replace the D.NET module.
	DN1 □□□□	An error was detected in the D.NET module numbered 1.	See “7.3.2 Error indications and required actions.”
2	DN2 @. @	The D.NET module numbered 2 has started up normally.	This is not an error.
	EXF2 PTY	A parity error occurred when the CPU read memory data from the D.NET module numbered 2.	Reset the CPU once. If the indication still appears, replace the D.NET module.
	DN2 □□□□	An error was detected in the D.NET module numbered 2.	See “7.3.2 Error indications and required actions.”
3	DN3 @. @	The D.NET module numbered 3 has started up normally.	This is not an error.
	EXF3 PTY	A parity error occurred when the CPU read memory data from the D.NET module numbered 3.	Reset the CPU once. If the indication still appears, replace the D.NET module.
	DN3 □□□□	An error was detected in the D.NET module numbered 3.	See “7.3.2 Error indications and required actions.”

The portion “@. @” above represents the version and revision of the D.NET module.

### 7.3.2 Error indications and required actions

In the S10mini, when the D.NET module detects a hardware error, one of the indications listed in the “CPU indication” column of Table 7-4 is displayed on the indicator of the CPU module. In the S10V, you can obtain error information as shown in Tables 7-4 and 7-5 by selecting the relevant error log in the S10V base system.

When any of the listed hardware errors occurs, the D.NET module stops its operation.

#### (1) Hardware errors (module stopped)

Table 7-4 Error Indications and Required Actions

Module state		CPU indication (S10mini)	Error code (S10V)	Error description	Required action
Hardware error (Module stopped)	Initial diagnosis	MPUR	0x1401	MPU register compare error	Reset the CPU or LPU module. If the same error indication still appears, the D.NET module may be in failure. Replace the D.NET module.
		MPUA	0x1402	MPU operation check error	
		CANM	0x1403	CAN register compare error	
		SHM	0x1404	MPU built-in memory compare error	
		ROMC	0x1405	FROM compare check error	
		ROM1	0x1406	FROM checksum error (microprogram)	
		RAMC	0x1407	SRAM compare check error	
		PRCP	0x1408	Microprogram copy error	
		TIM	0x1409	MPU built-in timer diagnosis error	
	MDSW	0x140A	MODU No. switch setting error	Check the MODU No. switch setting.	
	SBCP	0x140B	OS copy error	Reset the CPU or LPU module. If the same error indication still appears, the D.NET module may be in failure. Replace the D.NET module.	
	ROM2	0x140C	FROM checksum error (OS subsystem)		
	ROM3	0x140D	FROM checksum error (parameter)		
	In operation	PTY1	0x2403	Shared-memory parity error	
WDT		0x2404	Watch-dog-timer timeout error		
ILLG		0x3404	General illegal instruction		
SLOT		0x3406	Slot illegal instruction		
ADDR		0x3409	Address error		
EXCP		0x34XX	Undefined interrupt		

### **NOTICE**

In the S10mini, if the D.NET module's red MNS indicator lights up and the CPU module's indicator shows nothing, the D.NET module may be in failure. Replace the module.

## 7 MAINTENANCE

### (2) Network errors (communication stopped)

Extension error codes may be additionally generated for certain network errors. These extension error codes are as listed below.

Table 7-5 Extension Error Codes (Network Errors) and Required Actions

Error code	Error description	Extension error code		Extension error description	Required action
		Upper byte	Lower byte		
0x4181	Duplicate MAC ID (remote node with its MAC ID duplicated is stopped)	MAC ID (0x0000 to 0x003F)		Duplicate MAC ID	(*1)
0x4281	Duplicate MAC ID (local node with its MAC ID duplicated is stopped)	MAC ID (0x0000 to 0x003F)		Duplicate MAC ID	
0x5188	Communication frame count setting error (*4)	None		None	Check the parameter settings.
0x5189	Parameter setting error	0x01 (Port No. error)	Port No. (0x01-0xA0)	The specified port no. is out of the permitted range /1 to /A0.	
		0x02 (Message ID error)	Port No. (0x01-0xA0)	The specified message ID is out of the permitted range /0 to /F.	
		0x03 (Cycle error)	Port No. (0x01-0xA0)	This type of error does not occur in the LQE570/575.	
		0x04 (Transfer word count error)	Port No. (0x01-0xA0)	The specified word count for transfer is out of the permitted range /0 to /100.	
		0x05 (Com. modes mixed)	Port No. (0x01-0xA0)	The master-peer and slave modes are both specified for combined use.	
		0x06 (MAC ID error)	Port No. (0x01-0xA0)	The specified MAC ID is out to the permitted range /0 to /3F, or the local MAC ID is specified.	
		0x07 (Com. type error)	Port No. (0x01-0xA0)	The specified communication type is other than peer transmission, peer reception, Poll, or Bit Strobe.	
		0x08 (Transfer address error)	Port No. (0x01-0xA0)	The specified transfer address is out of the permitted range.	
		0x0A (Transfer word count error)	Always 0x00	The specified word count for transfer is out of the permitted range /0 to /8.	
		0x0B (Too many cases specified for registration)	MAC ID (0x00-0x3F)	Too many cases of D.Station data format conversion are specified for registration. (Up to 8 cases can be registered for each D. Station.)	
		0x10 (Send-word count error)	Always 0x00	The specified send-word count for transmission in slave mode is out of the permitted range /0 to /100.	
		0x11 (Receive-word count error)	Always 0x00	The specified receive-word count for reception in slave mode is out of the permitted range /0 to /100.	
		0x12 (Com. modes mixed)	Always 0x00	The master-peer and slave modes are both specified for use in slave mode.	
		0x13 (Com. type error)	Always 0x00	A communication type other than Poll is specified for use in slave mode.	
		0x14 (Transfer address error)	Always 0x00	The specified transfer address for use in slave mode is out of the permitted range.	
0x7381	Transmission path bus-off condition detected	None		None	(*2)
0x8181	CAN transmission timeout generated	CAN ID		CAN ID in the send frame when the transmission timeout was generated.	(*2) (*3)

(\*1) Check the set value of the Node Address setting switch.

(\*2) Check the connectors for looseness, and check the cable wiring and the transfer rate, MAC ID, and MODU No. settings.

(\*3) A CAN transmission timeout is also generated in the following cases, where the D.NET module functions normally.

- The D.NET module's communication connector is not connected.
- No other station exists or the power to the other station is OFF.
- The transmission speed of the other station does not match the local station's.
- The CAN transmission timeout error does not occur if a module other than the D.NET exists in the network. (This type of error does not occur if there is a communication party in the network, regardless of whether the D.NET performs communication directly with it.)

(\*4) When the communication speed was set to 500 kbps or 250 kbps, the transmission of more than 17 frames per 10 ms was specified. When it was set to 125 kbps, the transmission of more than nine frames per 10 ms was specified.

**NOTICE**

A parameter error will occur if the D.NET module is mounted in a different machine model than the one under which parameters as shown in “4 OPERATION” have been set. Specifically, this is true with the following two cases:

Case 1: When the D.NET module whose parameters have been set for use under the S10V is installed in the S10mini, the message “DN\* PRM1” (“\*”: MODU No.) is displayed on the CPU’s indicator.

Case 2: When the D.NET module whose parameters have been set for use under the S10mini is installed in the S10V, the code 0x5189 is displayed in the error log information presented by the tool (S10V base system).

The above features are intended to prevent a malfunction due to a reference made to the parameters used under a different machine model.

A parameter error will also occur if a checksum error occurs in relation to the contents of the existing parameter settings. In this case, open the relevant parameter setting window under the machine model in which the D.NET module is mounted, and add a change to the existing parameter settings if necessary.

## 7 MAINTENANCE

### 7.4 Problem Report

Fill out this form and submit it to your local Hitachi dealer.

Your company's name		Person in charge	
Date and time of occurrence		(year / month / day / hours / minutes)	
Where to make contact	Address		
	Telephone		
	FAX		
	E-mail		
Model of defective module		CPU/LPU model	
OS	Ver.	Rev.	Program name: Ver. Rev.
Support program		Program name: Ver. Rev.	
Symptom of defect			
Connected load	Type		
	Model		
	Wiring state		
System configuration and switch settings			
Space for correspondence			