



US008898384B2

(12) **United States Patent**  
**Kawaguchi**

(10) **Patent No.:** **US 8,898,384 B2**

(45) **Date of Patent:** **Nov. 25, 2014**

(54) **FAST ACCESSIBLE COMPRESSED THIN  
PROVISIONING VOLUME**

(56)

**References Cited**

(75) Inventor: **Tomohiro Kawaguchi**, Cupertino, CA (US)  
(73) Assignee: **Hitachi, Ltd.**, Tokyo (JP)  
(\* ) Notice: Subject to any disclaimer, the term of this patent is extended or adjusted under 35 U.S.C. 154(b) by 0 days.

U.S. PATENT DOCUMENTS

5,247,638	A	9/1993	O'Brien et al.
6,145,069	A	11/2000	Dye
6,320,521	B1	11/2001	Har et al.
7,130,960	B1	10/2006	Kano
7,543,129	B2	6/2009	Kato et al.
7,747,799	B2	6/2010	Nakagawa et al.
7,822,939	B1	10/2010	Veprinsky et al.
2006/0004968	A1	1/2006	Vogt
2006/0242431	A1	10/2006	LeCrone et al.
2006/0256466	A1	11/2006	Katagiri et al.

(21) Appl. No.: **13/234,078**  
(22) Filed: **Sep. 15, 2011**

OTHER PUBLICATIONS

LTO (Linear Tape-Open): One of the standard format of tape media <http://www.lto-technology.com/newsite/index.html>, Nov. 30, 2007.  
Microsoft® Windows® NTFS : Supports file level compression, "Local File Systems for Windows" [Http://www.microsoft.com/whdc/device/storage/LocFileSys.mspx](http://www.microsoft.com/whdc/device/storage/LocFileSys.mspx), May 5, 2004.

(65) **Prior Publication Data**  
US 2012/0054438 A1 Mar. 1, 2012

**Related U.S. Application Data**

(63) Continuation of application No. 11/948,948, filed on Nov. 30, 2007, now Pat. No. 8,131,927.

*Primary Examiner* — Michael Alsip  
(74) *Attorney, Agent, or Firm* — Mattingly & Malur, PC

(51) **Int. Cl.**  
**G06F 12/00** (2006.01)  
**G06F 13/00** (2006.01)  
**G06F 13/28** (2006.01)  
**G06F 9/26** (2006.01)  
**G06F 9/34** (2006.01)  
**G06F 3/06** (2006.01)  
**G06F 12/08** (2006.01)

(57) **ABSTRACT**

A computerized data storage system includes at least one storage device including a nonvolatile writable medium; a cache memory and a data management controller and a storage port. The storage port is operable to receive a request to read data, and, in response to the request to read data, to send the data stored in the data storing area of the cache memory. The storage port is further operable to receive a request to write data, and, in response to the request to write data, to send the write data to the data storing area of the cache memory. The storage system further includes a thin provisioning controller operable to provide a virtual volume, and a capacity pool. The storage system further includes a data compression controller and a data decompression controller.

(52) **U.S. Cl.**  
CPC ..... **G06F 3/0665** (2013.01); **G06F 3/0608** (2013.01); **G06F 3/0656** (2013.01); **G06F 3/0689** (2013.01); **G06F 12/0866** (2013.01)  
USPC ..... **711/114**; 711/4; 711/112; 711/118; 711/203

(58) **Field of Classification Search**  
USPC ..... 711/4, 112, 114, 118, 203, E12.002; 707/693; 708/203; 710/68  
See application file for complete search history.

**11 Claims, 31 Drawing Sheets**

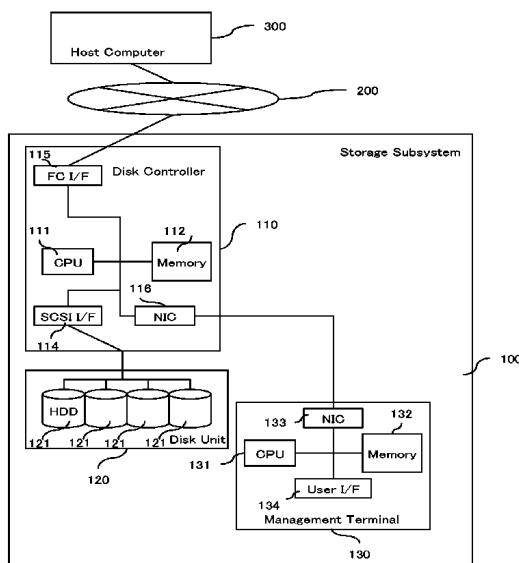

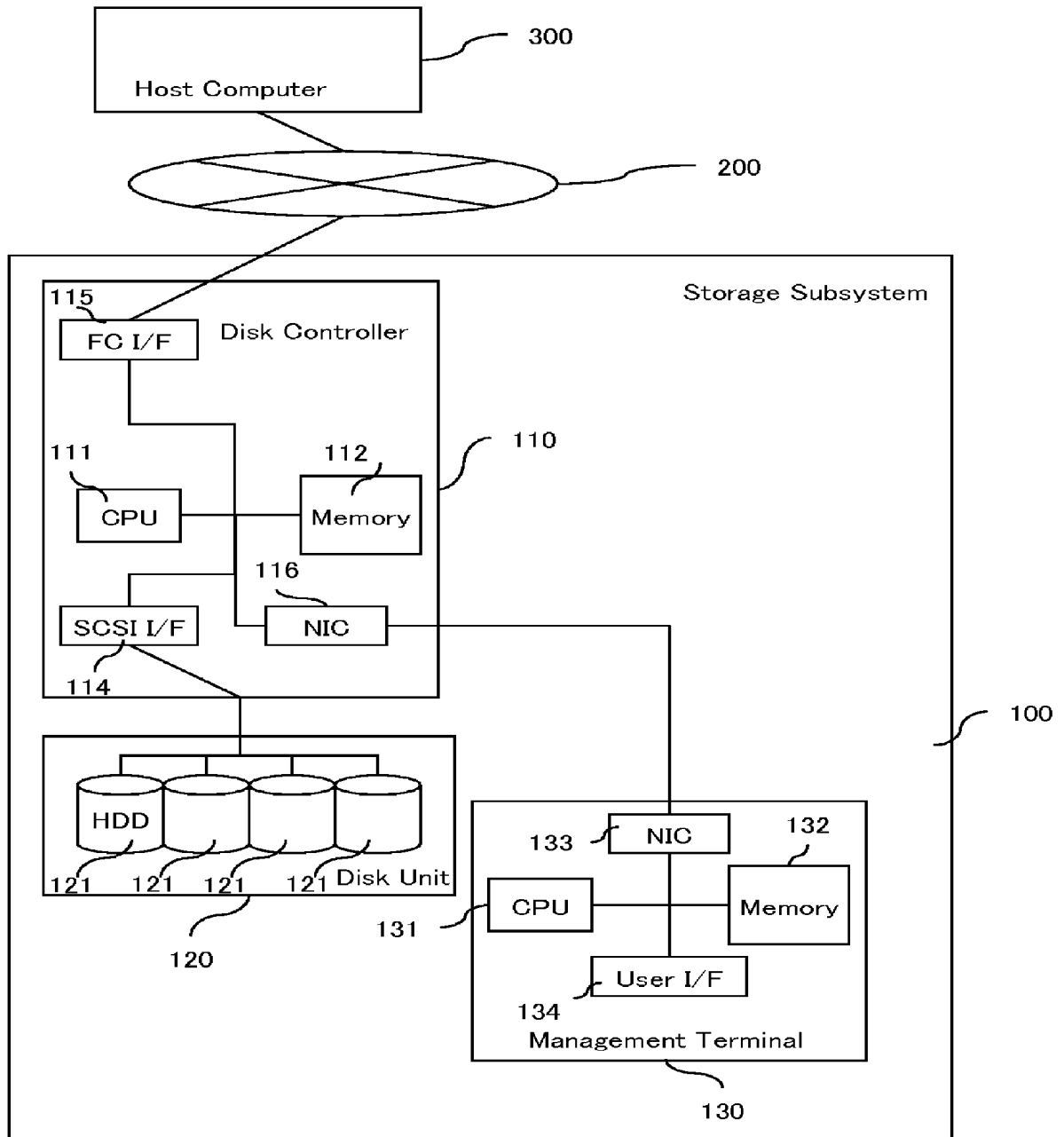
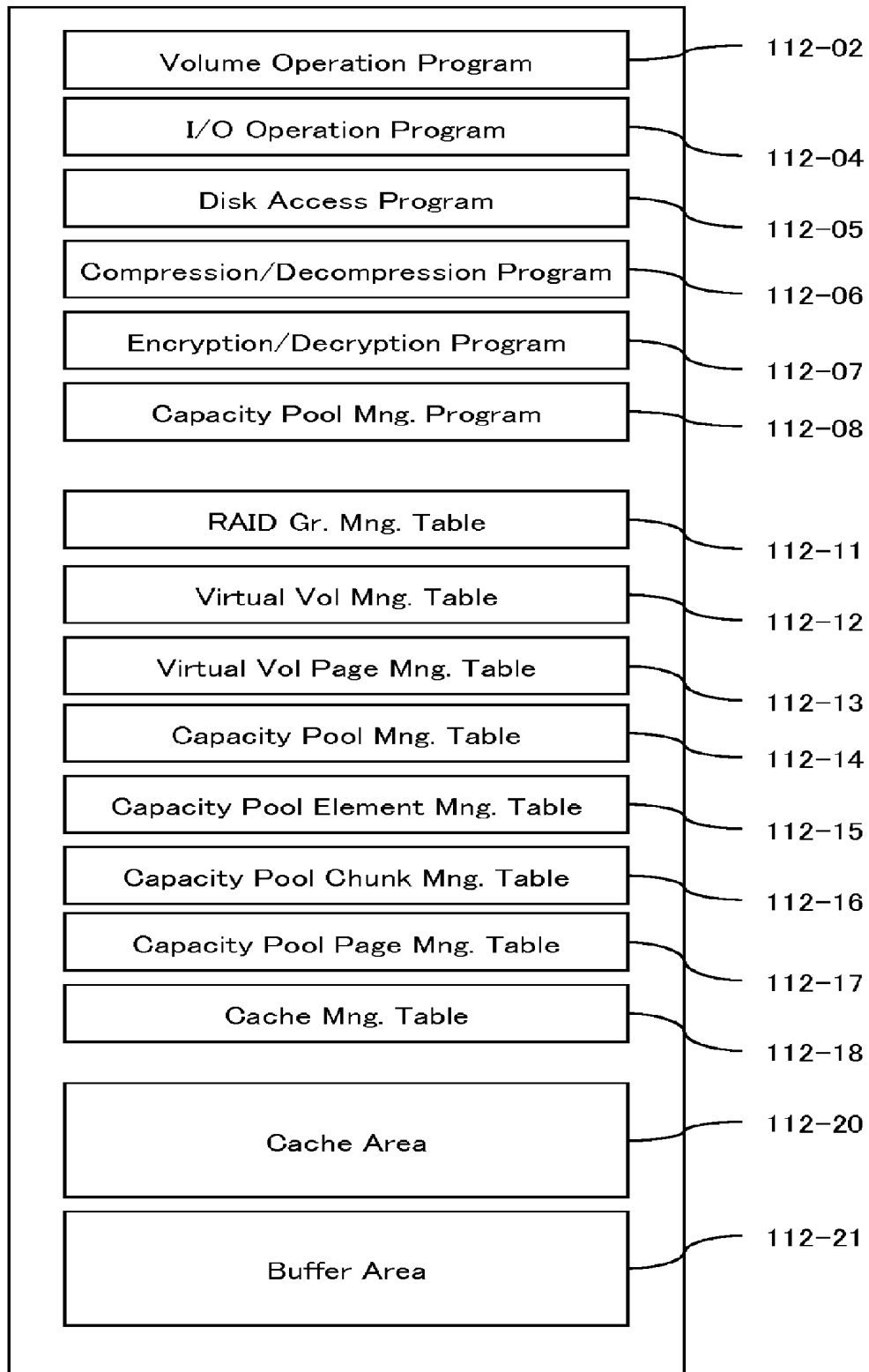

Fig. 1



112

Fig. 2

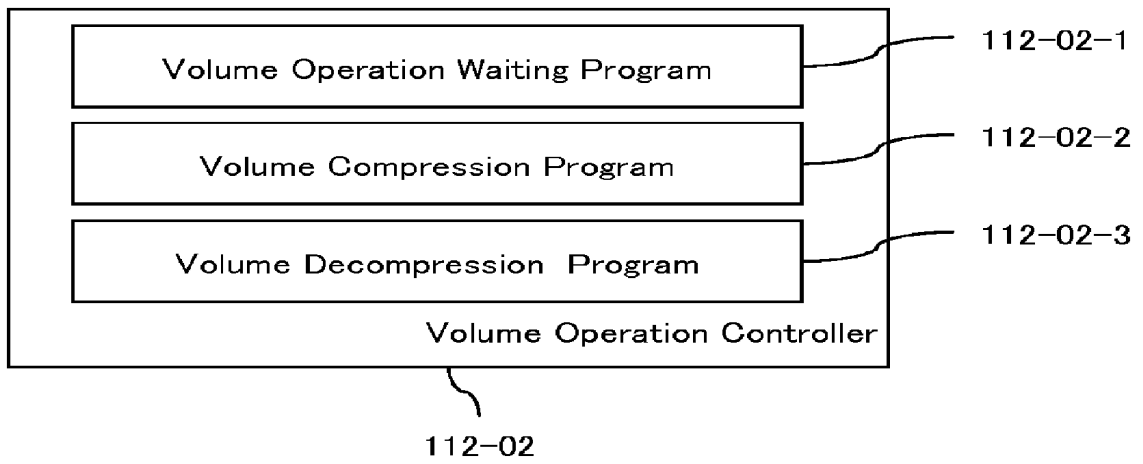

Fig. 3

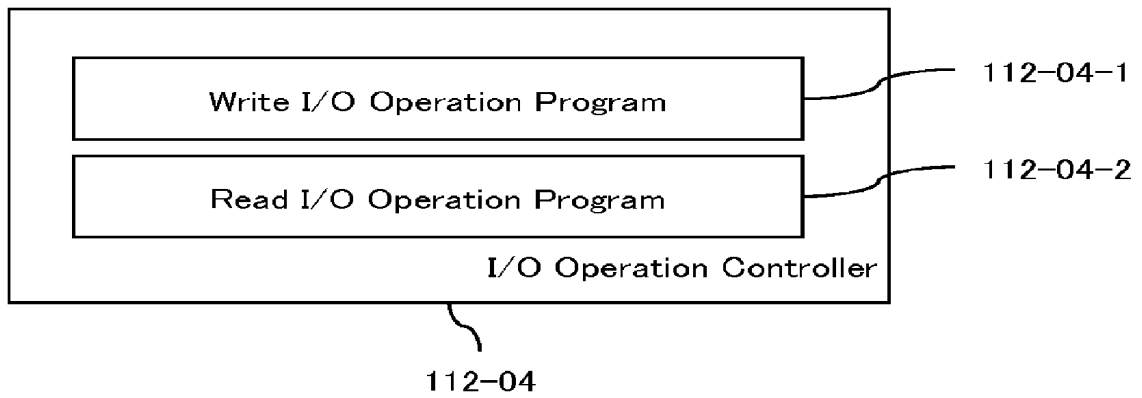

Fig. 4

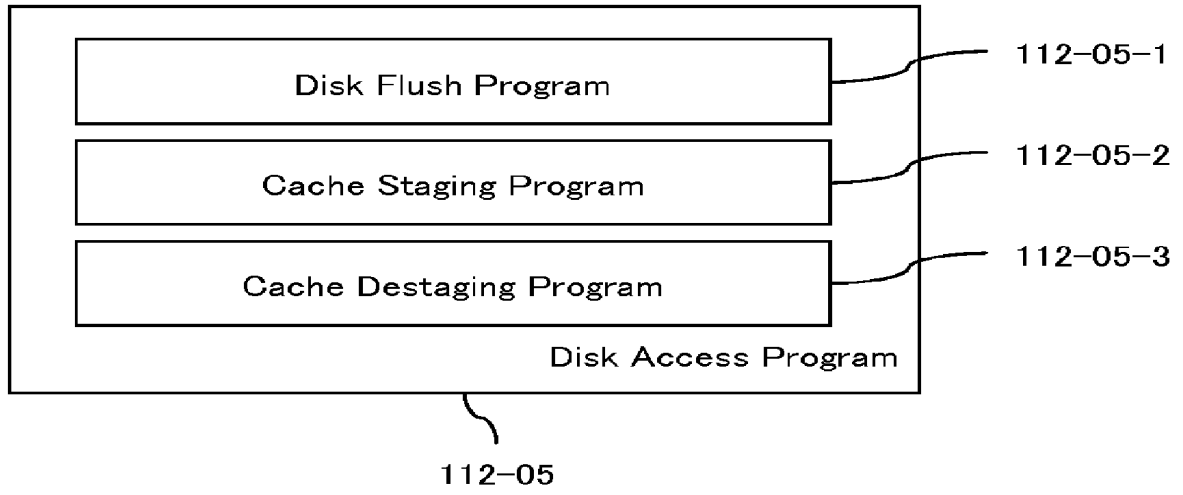

Fig. 5

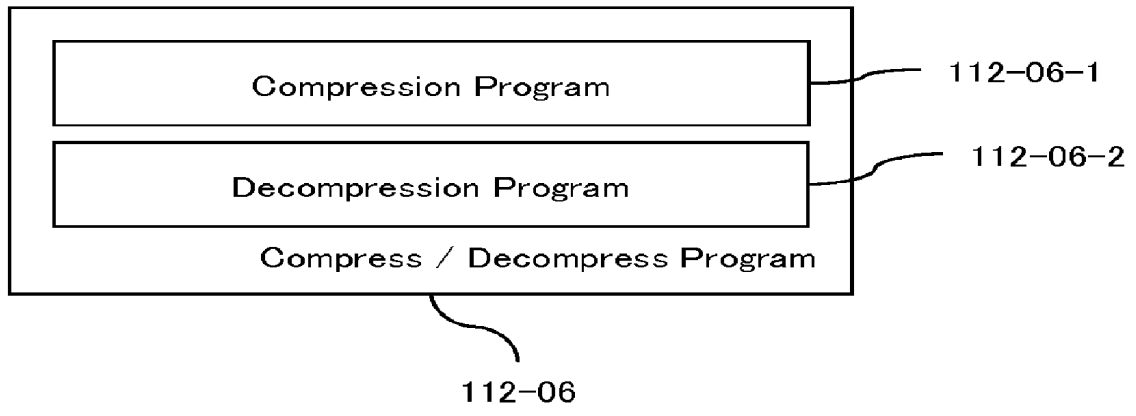

Fig. 6

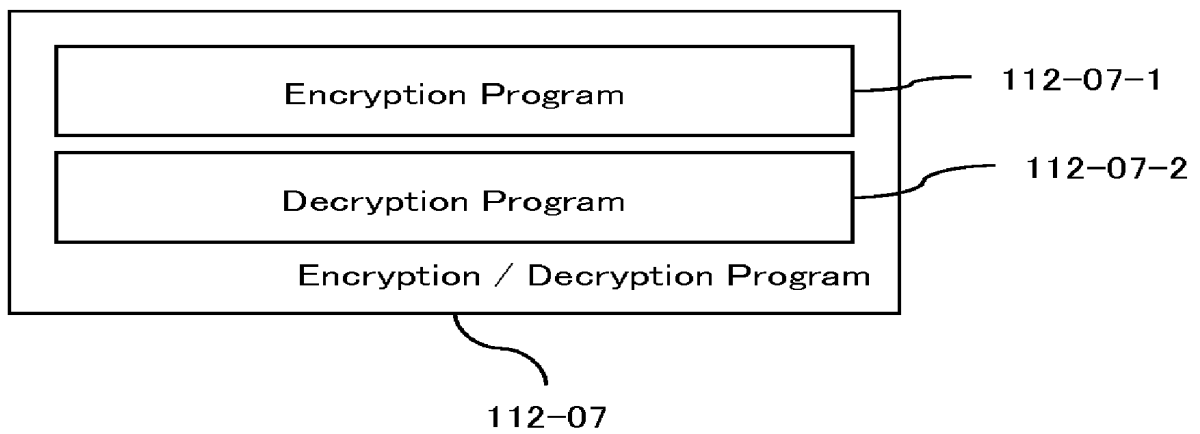

Fig. 7

112-11-01 RAID Gr.#	112-11-02 RAID Lv.	112-11-03 HDD#	112-11-04 HDD Capacity
0	5	0,1,2,3	40GB
1	6	4,5,6,7,8,9,10,11	100GB
2	10	12,13,14,15	100GB
3	N/A	N/A	N/A
4	10	32,33,34,35	20GB
5	10	40,41,42,43	300GB
6	5	64,65,66,67	40GB

112-11

Fig. 8

Volume#	Capacity	Capacity Pool#	Volume Type	Using RAID Gr. & Chunk#
0	0GB	N/A	N/A	N/A
1	500GB	2	Compressed	3 / 3
2	300GB	1	Compressed & Encrypted	1 / 19
3	0GB	N/A	N/A	N/A
4	500GB	2	Encrypted	3 / 21
5	0GB	N/A	N/A	N/A
6	1000GB	1	Thin Provisioning	1 / 16

112-12

Fig. 9



112-13-01 Top LBA Addr. of Virtual Vol. Page	112-13-02 RAID Gr.#	112-13-03 Top LBA Addr.of Capacity Pool Page	112-13-04 Allocated Capacity Pool Page Size
0x0000	10	0x4000	1024kB
0x0100	14	0x0200	256kB
0x0200	18	0x0000	3840kB
0x0300	N/A	N/A	N/A
0x0400	10	0x3200	768kB
0x0500	18	0x0200	256kB
0x0600	10	0x1000	4096kB

112-13

Fig. 10

112-14-01      112-14-02      11112-14-03

Capacity Pool#	RAID Gr. List	Free Capacity
0	1, 3, 5, 10, 12, 14	10MB
1	6, 8, 11	20MB
2	N/A	N/A

112-14

Fig. 11

112-15-01      112-15-02      112-15-03      112-15-04

RAID Gr.#	Capacity Pool#	Free Chunk Queue Index	Used Chunk Queue Index
10	0	8	8
11	1	15	15
12	0	3	3
13	N/A	Null	Null
14	0	31	31

112-15

Fig. 12

112-16-01 }	112-16-02 }	112-16-03 }	112-16-04 }	112-16-04 }
Chunk#	Virtual Volume#	Used Capacity	Deleted Capacity	Next Chunk Pointer
0	2	0	0kB	2
1	10	2048kB	1024kB	3
2	5	8192kB	768kB	1
3	7	4096kB	0kB	Null
4	N/A	0	0	31

112-16

Fig. 13

Capacity Pool Page Size	Virtual Volume Page#
256kB	10
128kB	27
1024kB	NULL
768kB	13
N/A	NULL

112-17

Fig. 14

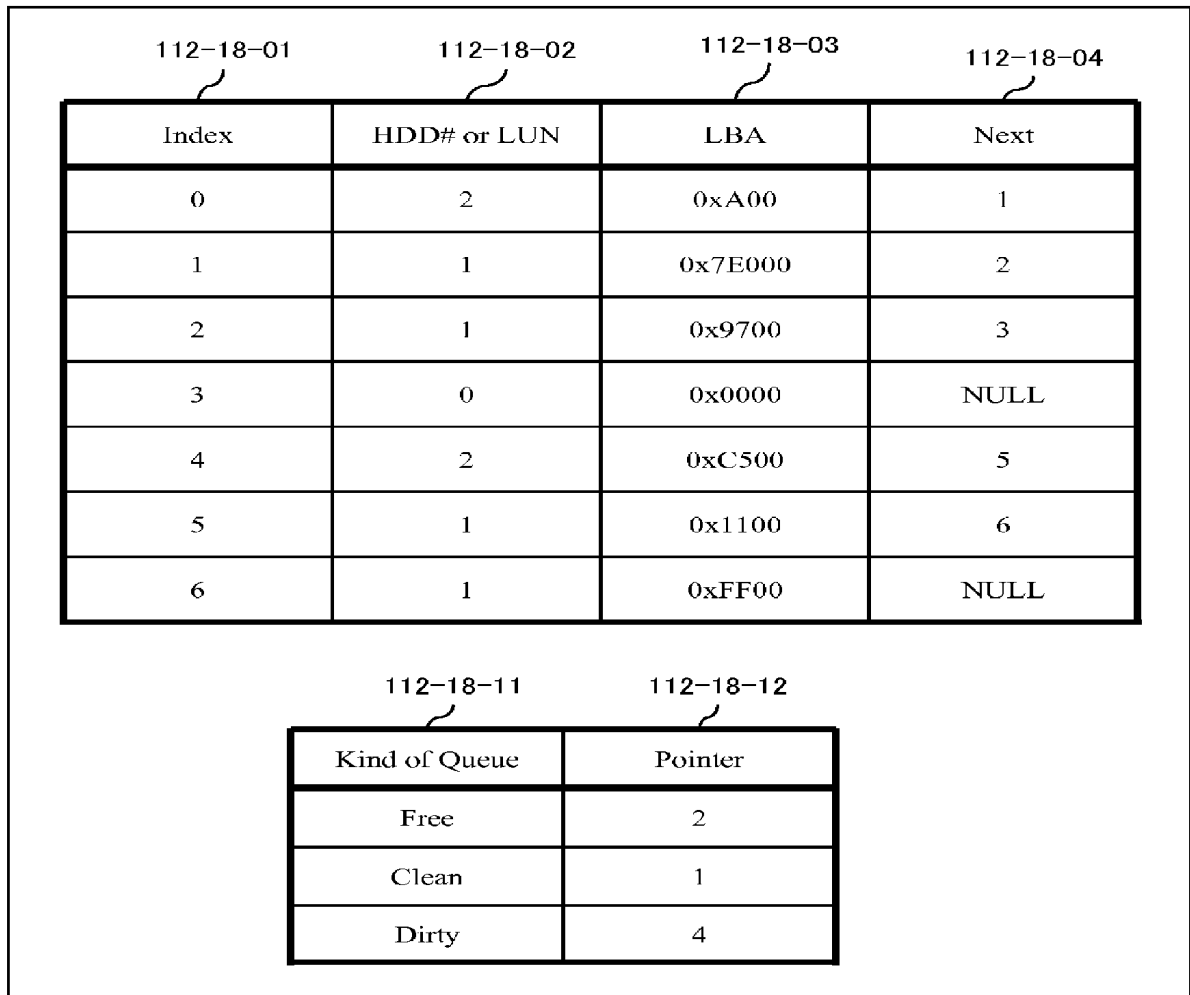

112-18  
Fig. 15

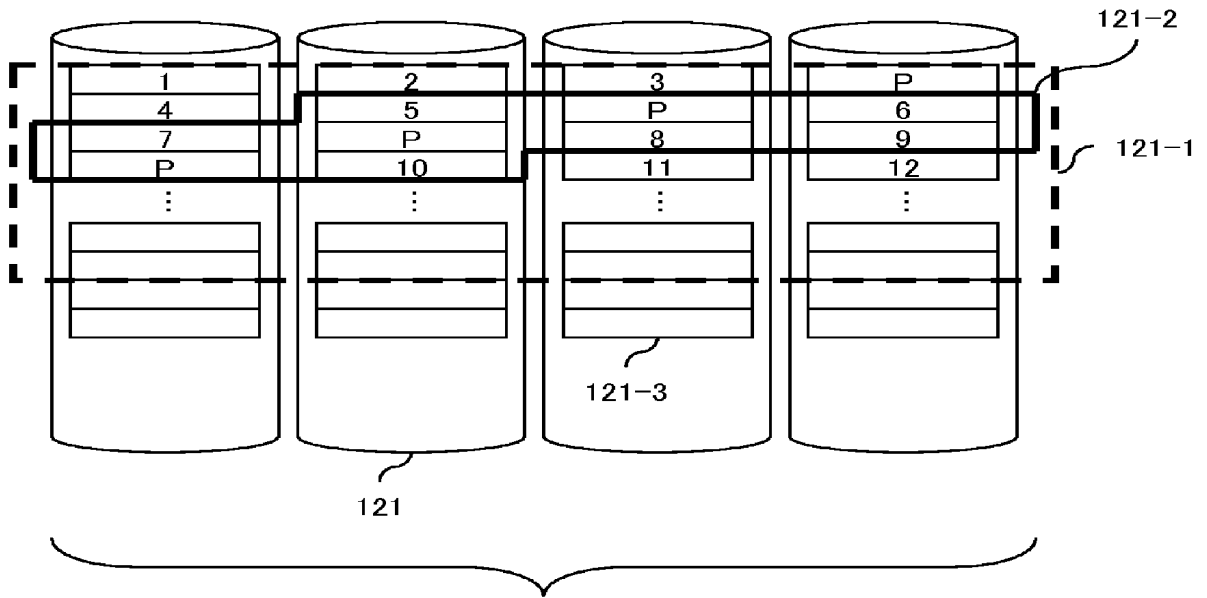

RAID Gr.

Fig. 16

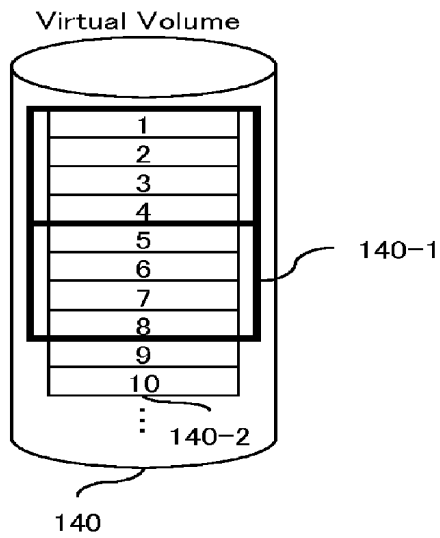

Fig. 17

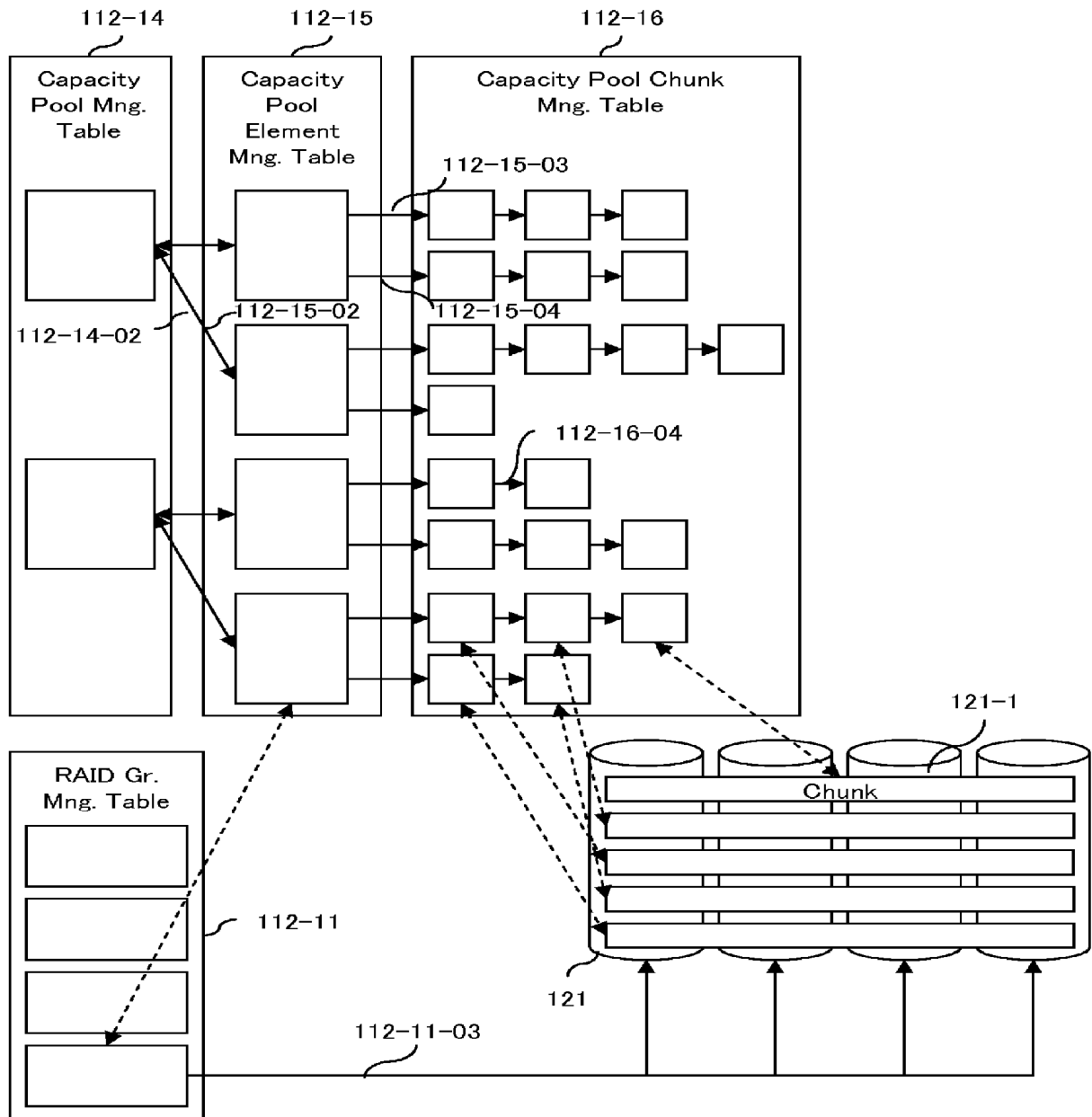

Fig. 18

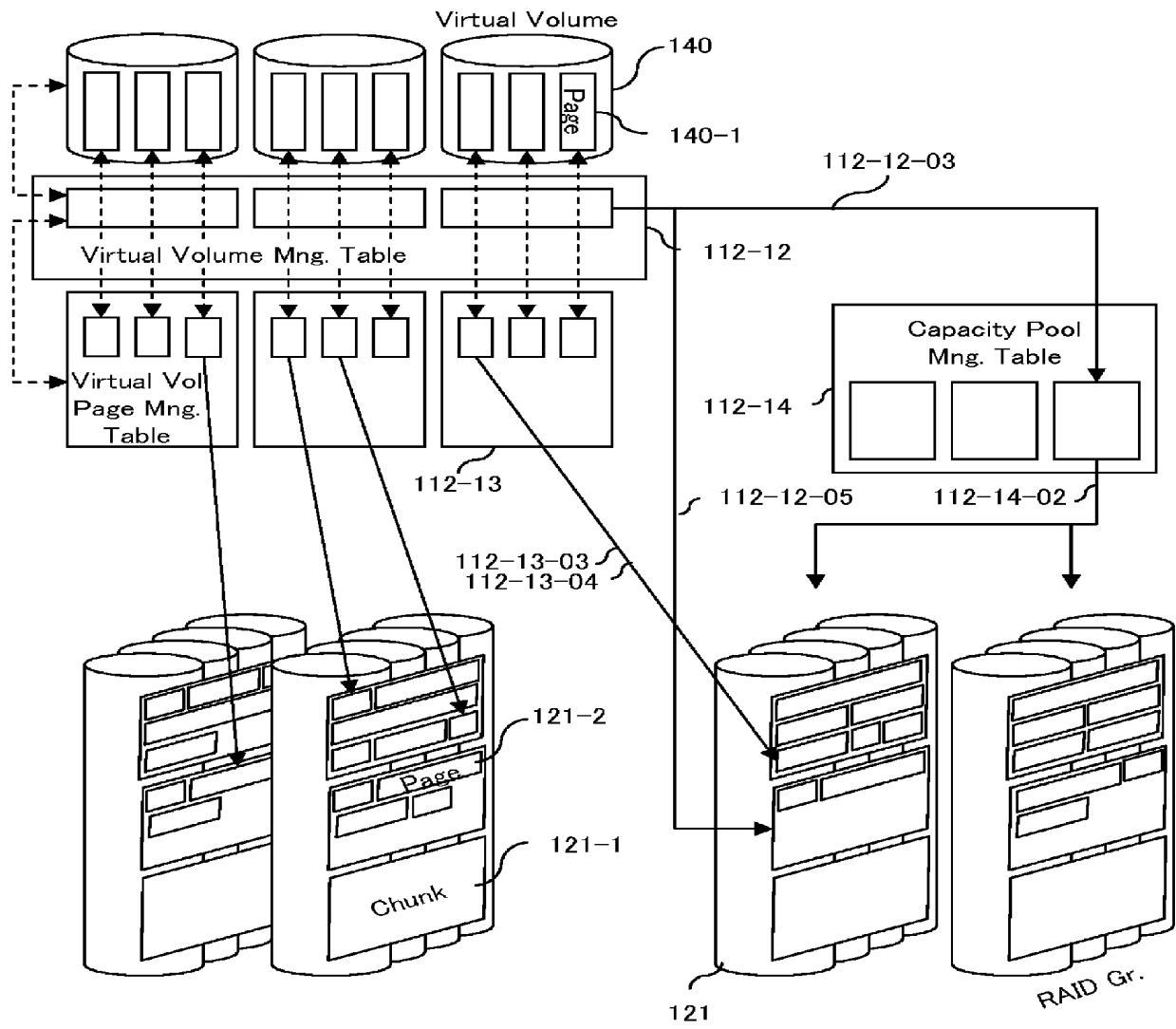

Fig. 19



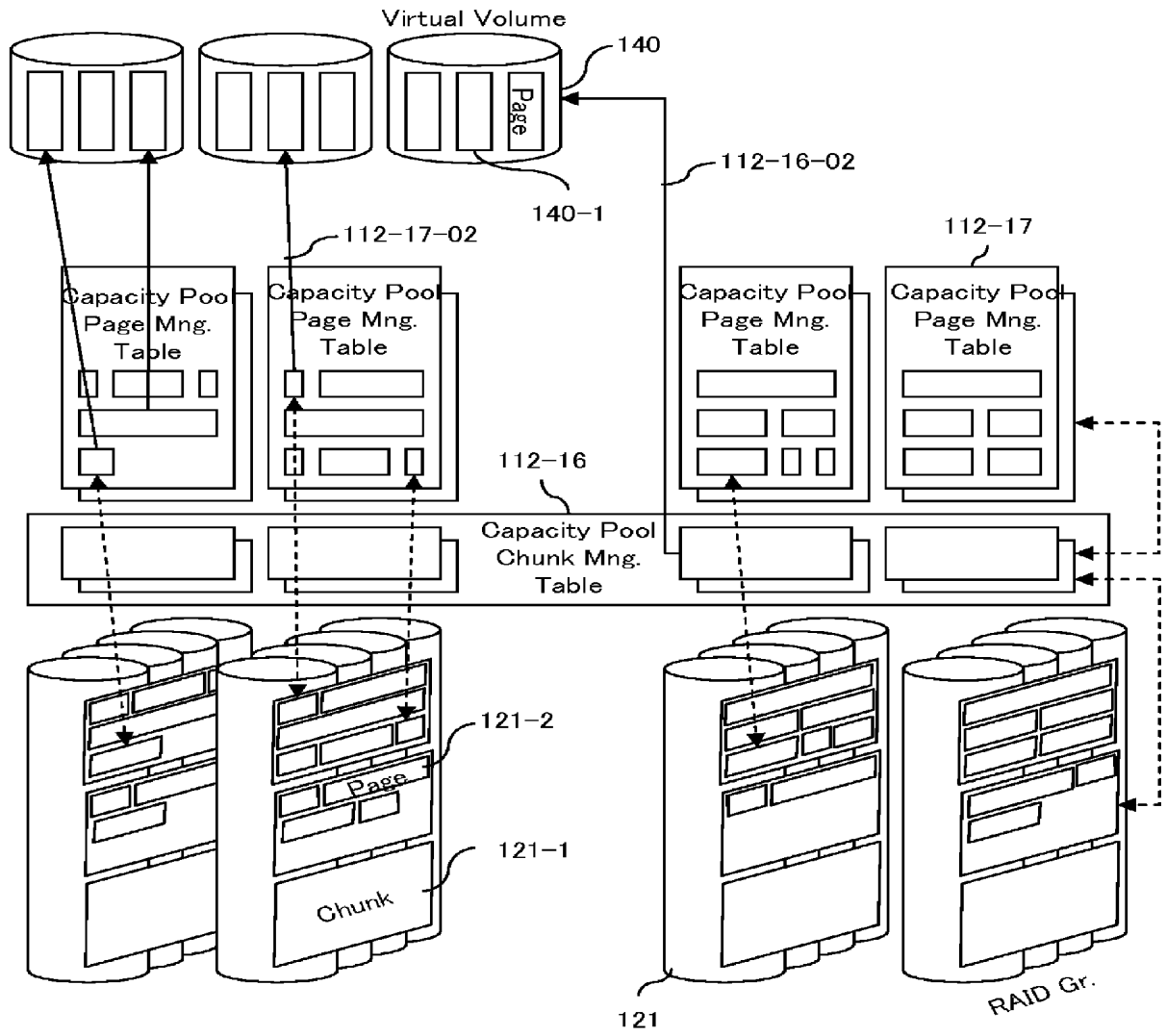

Fig. 20

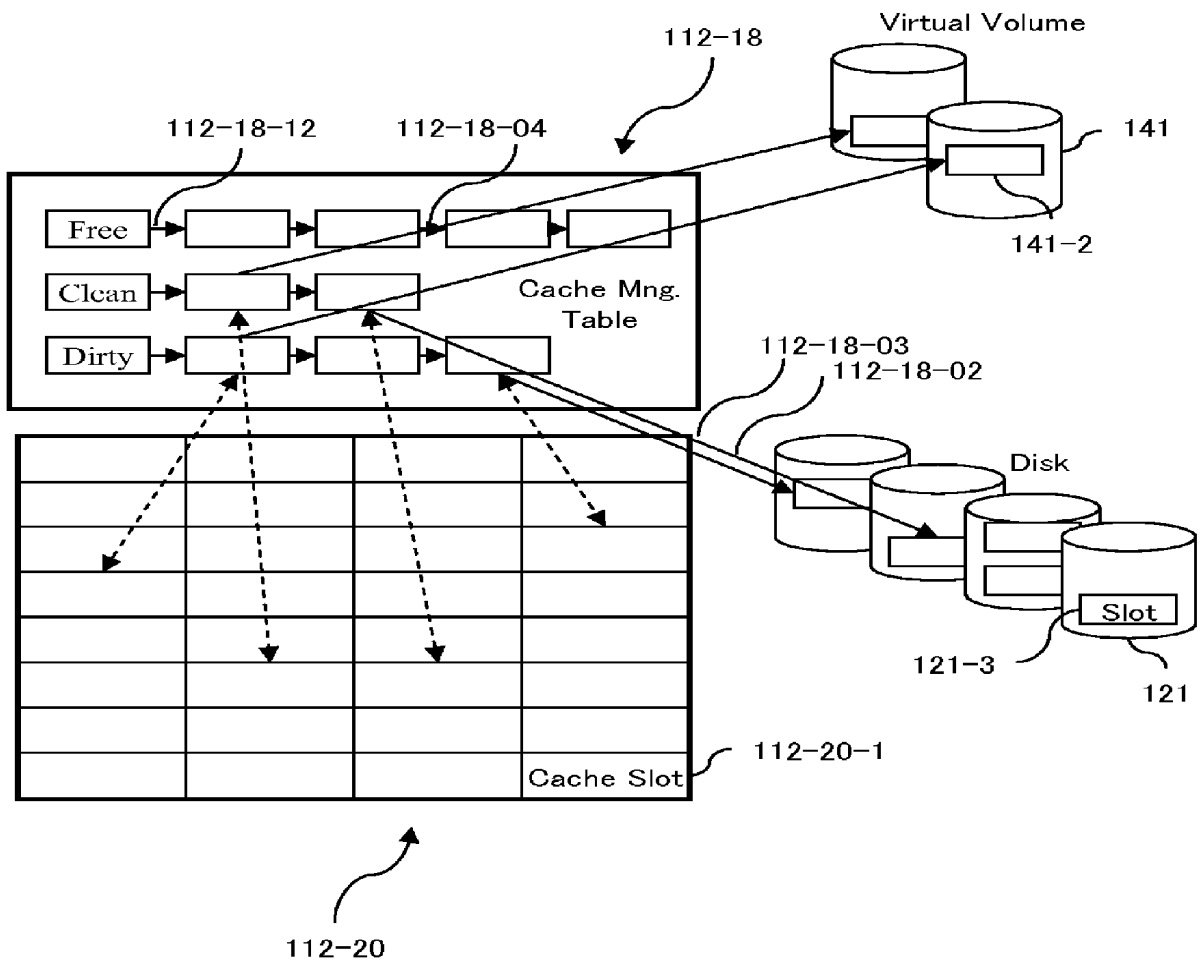

Fig. 21

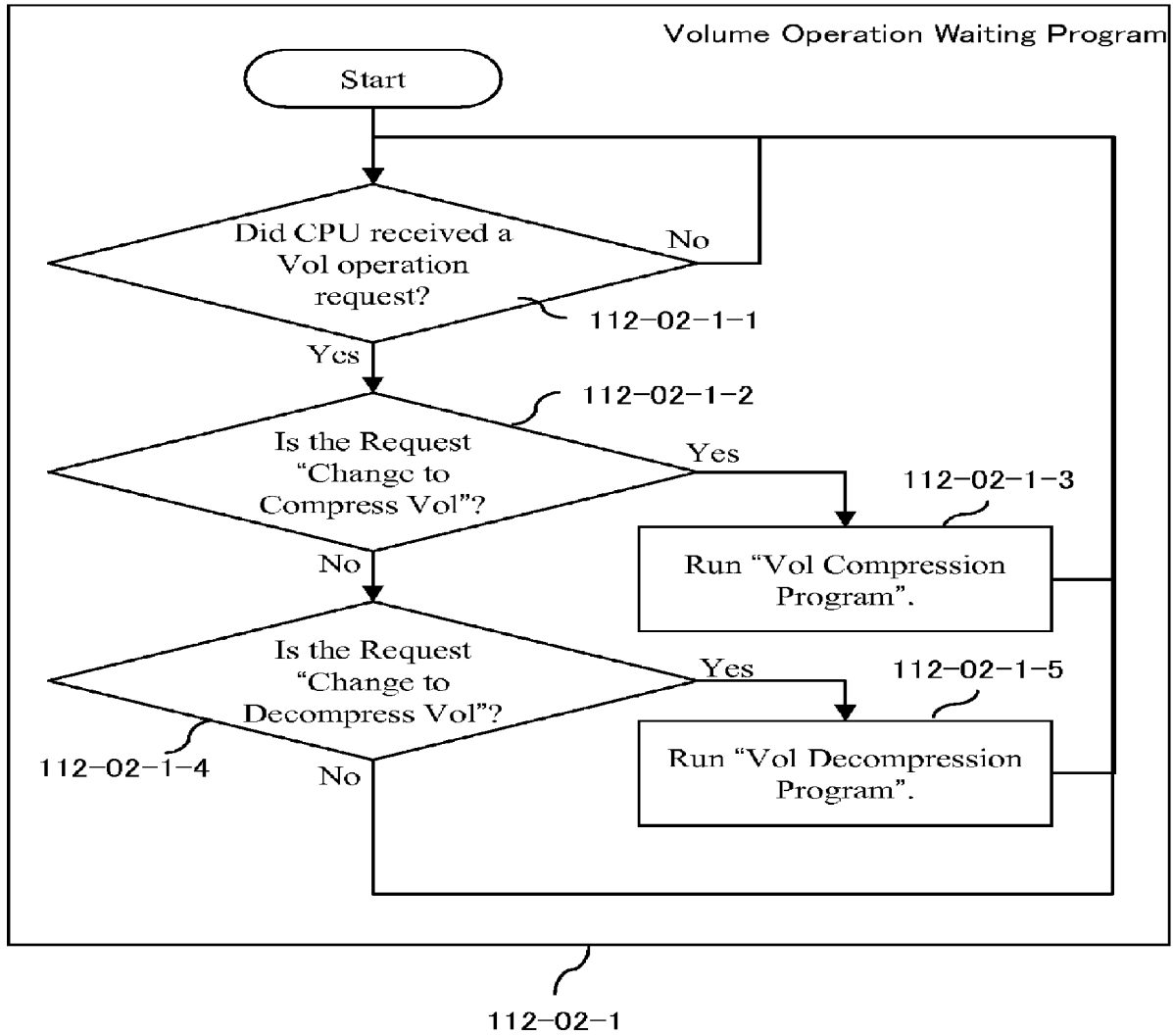
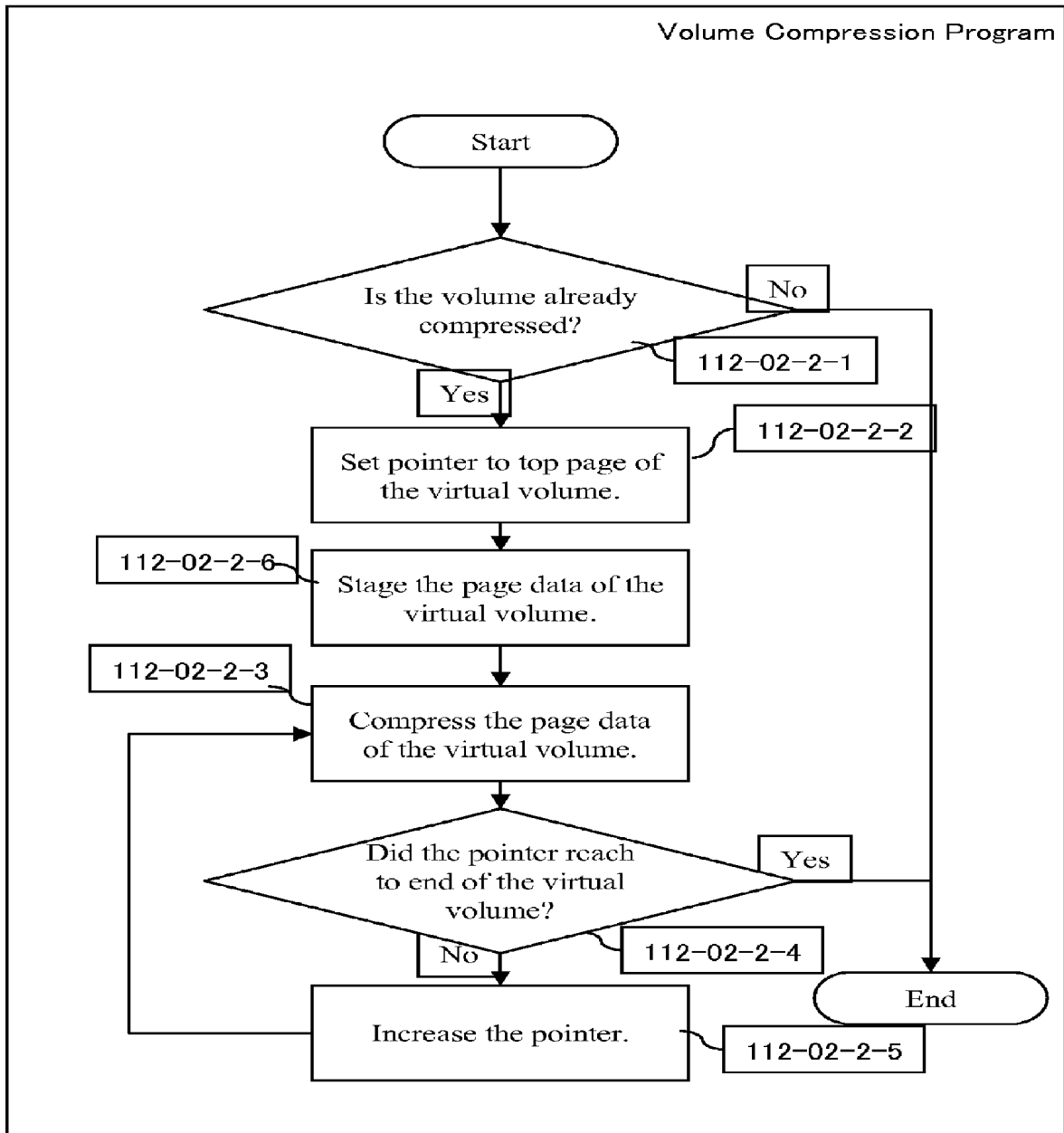

Fig. 22



112-02-2

Fig. 23

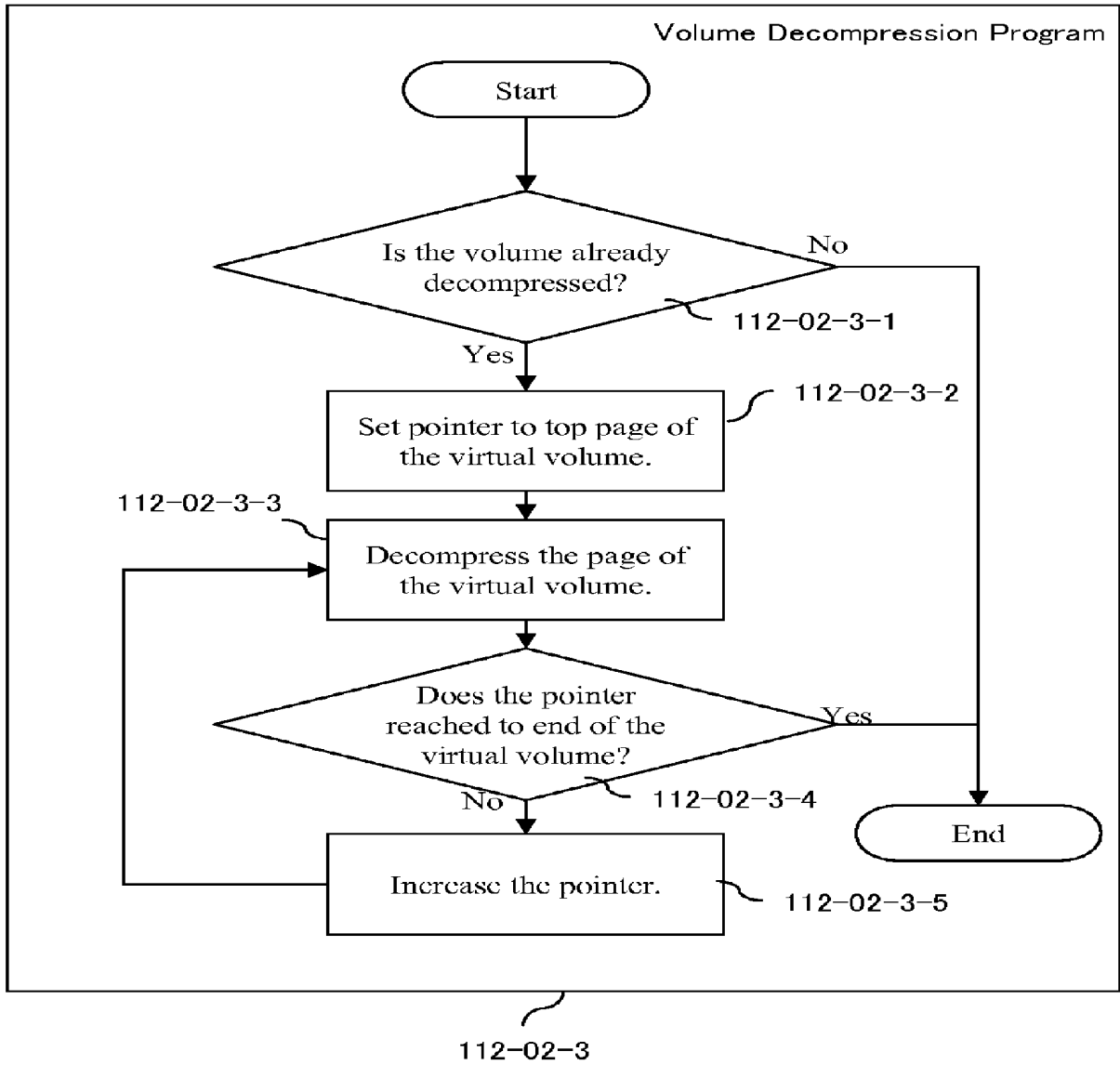
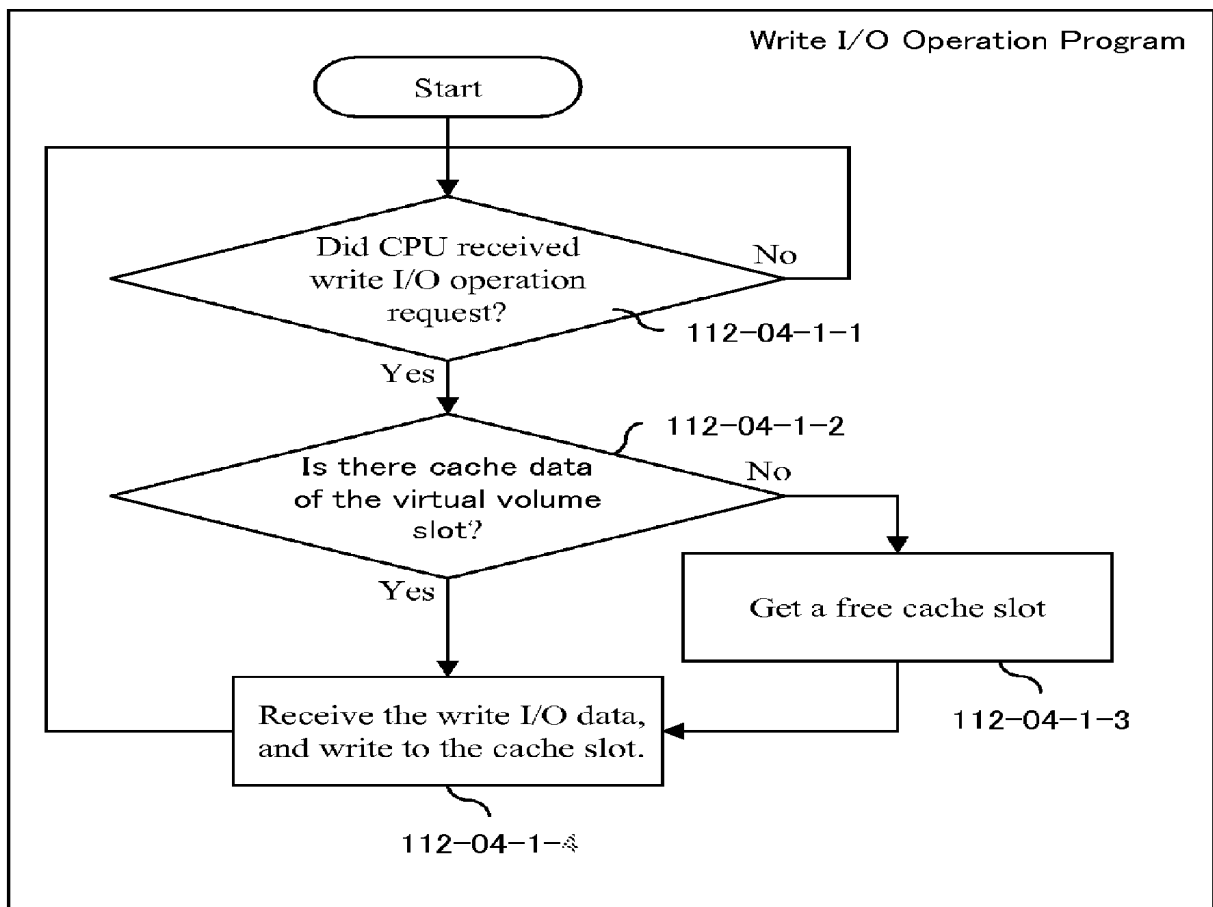

Fig. 24



112-04-1

Fig. 25

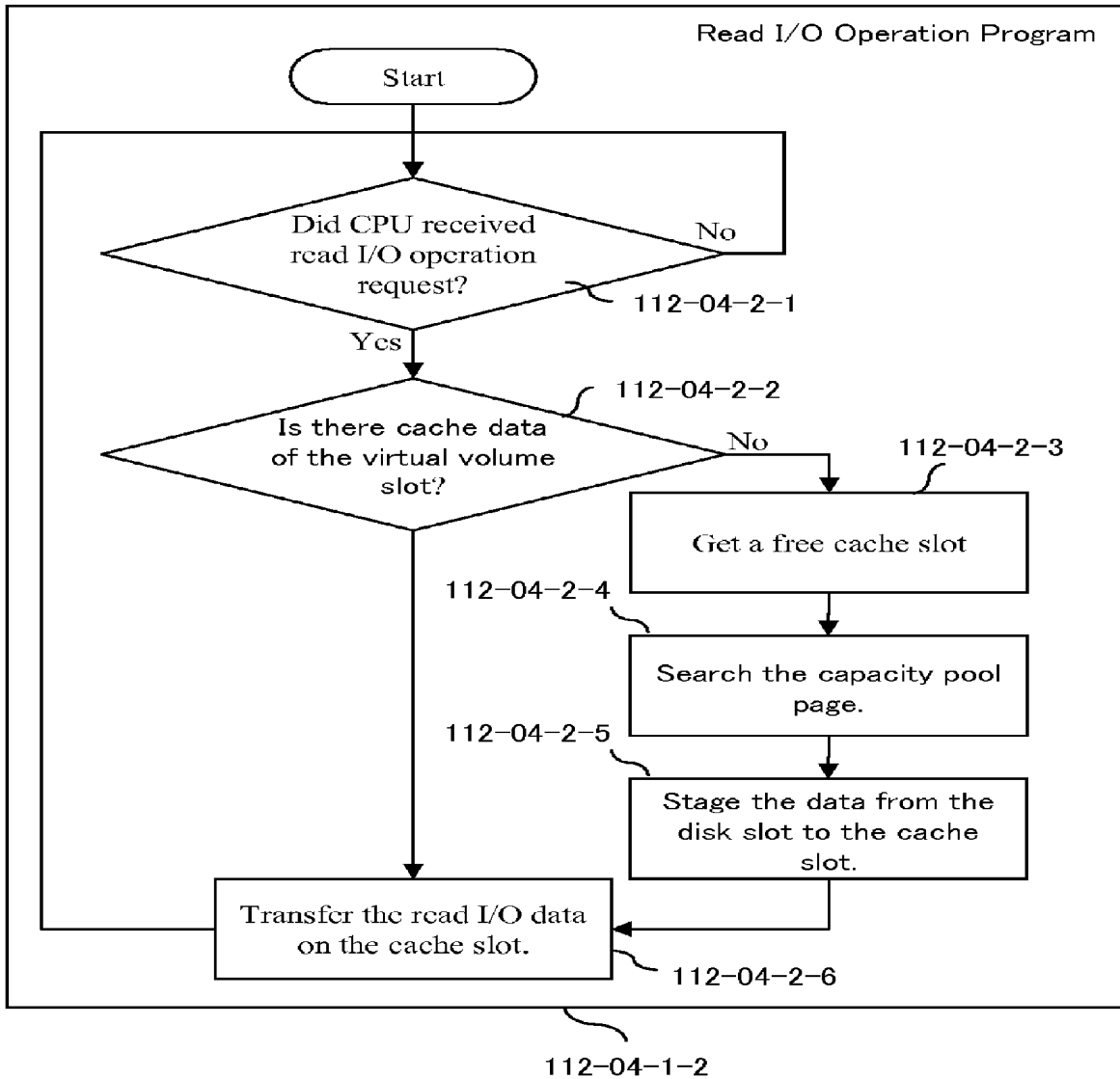
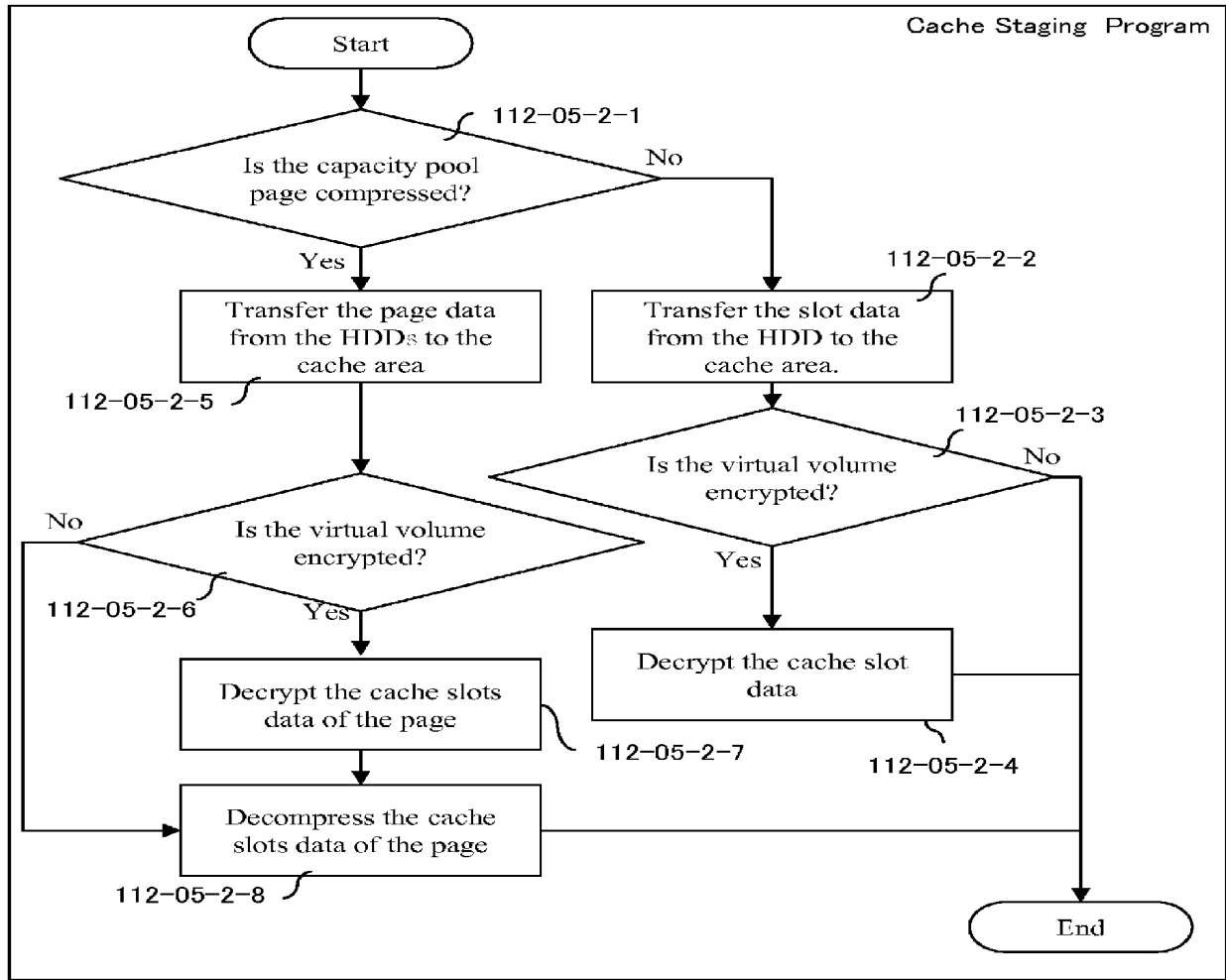

Fig. 26



112-05-2

Fig. 27



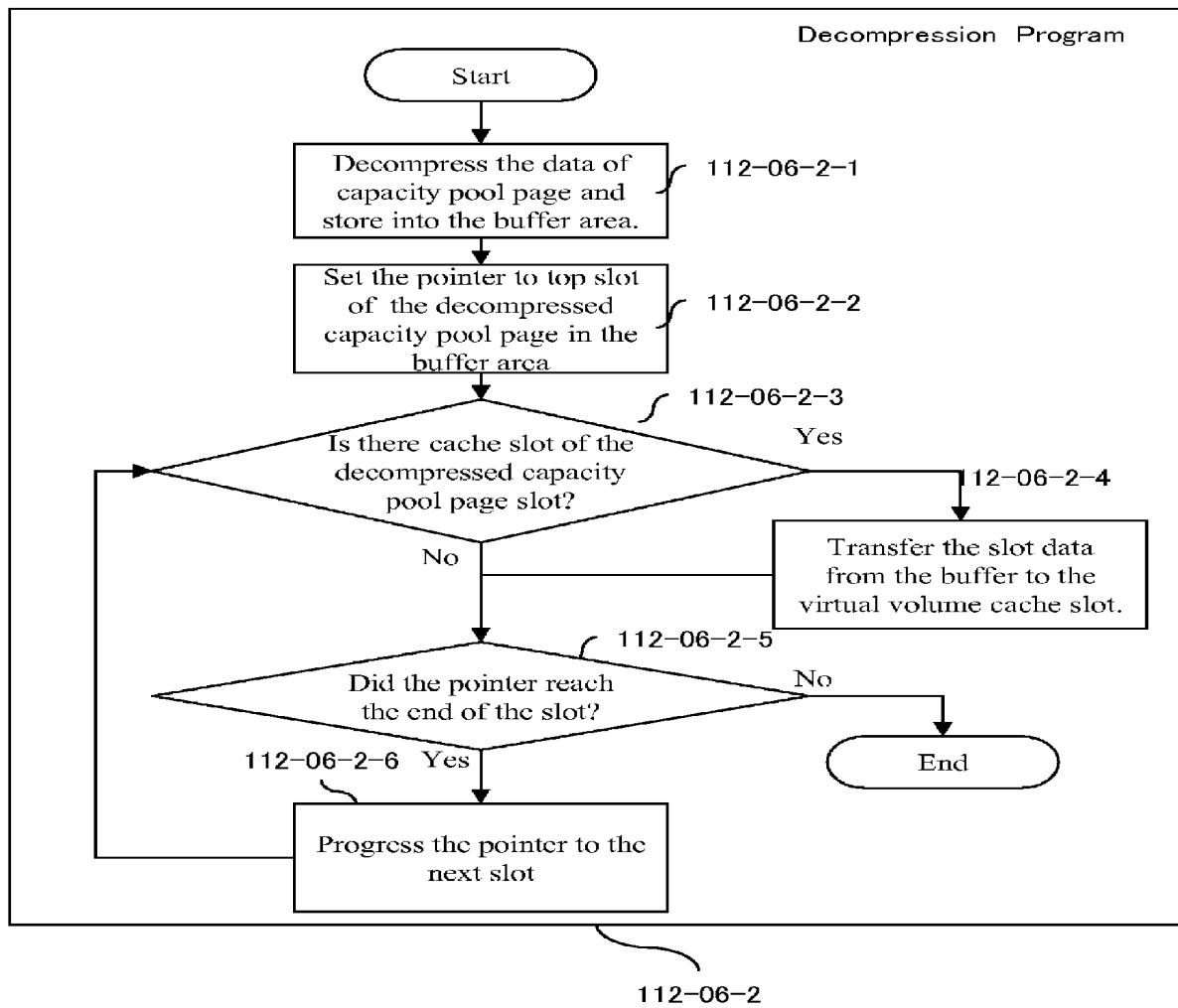
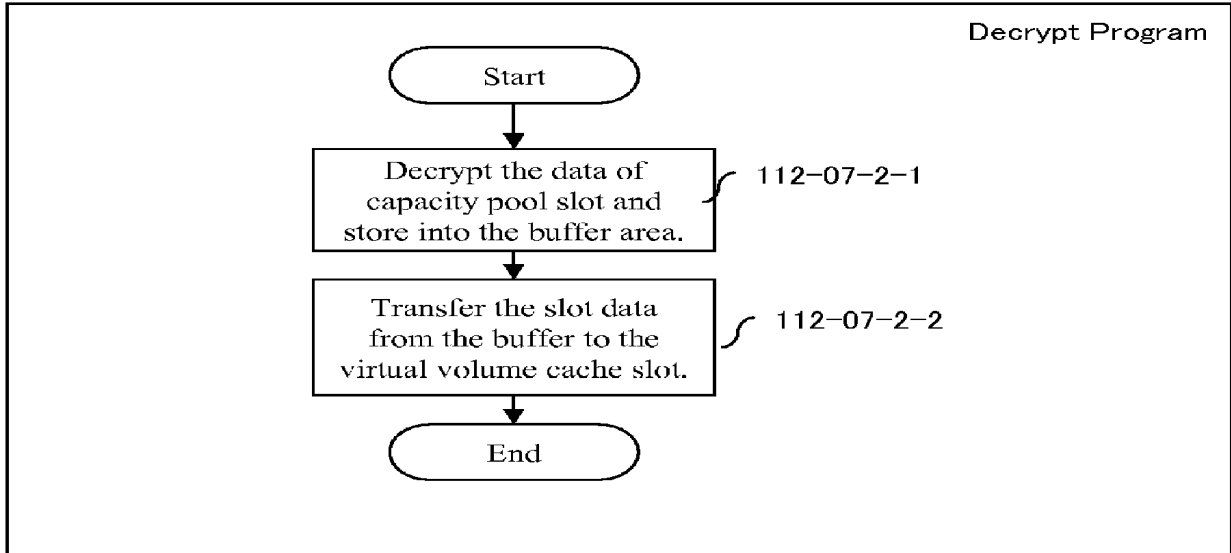
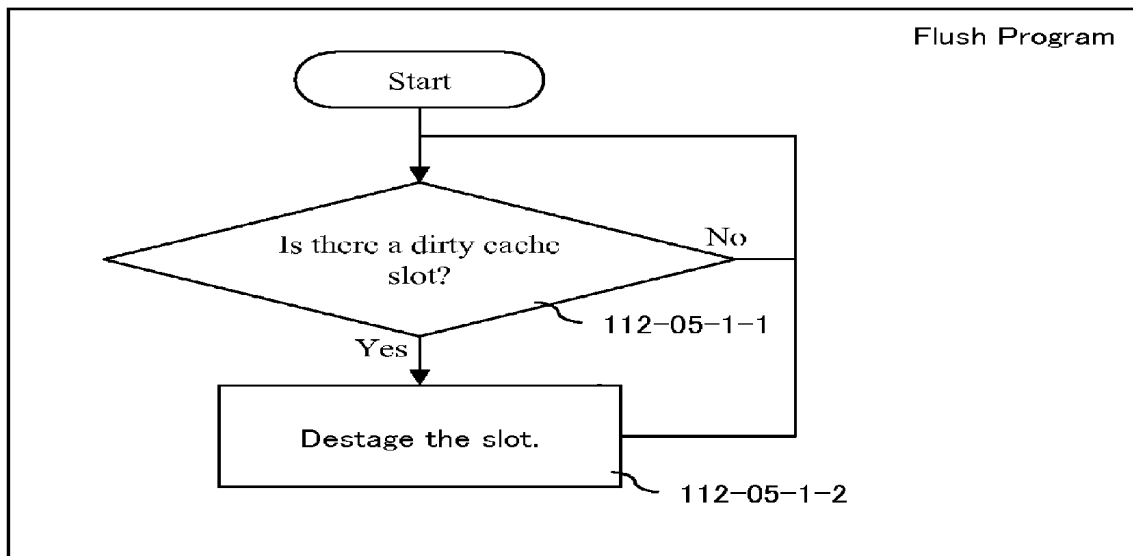

Fig. 28



112-07-2

Fig. 29



112-05-1

Fig. 30

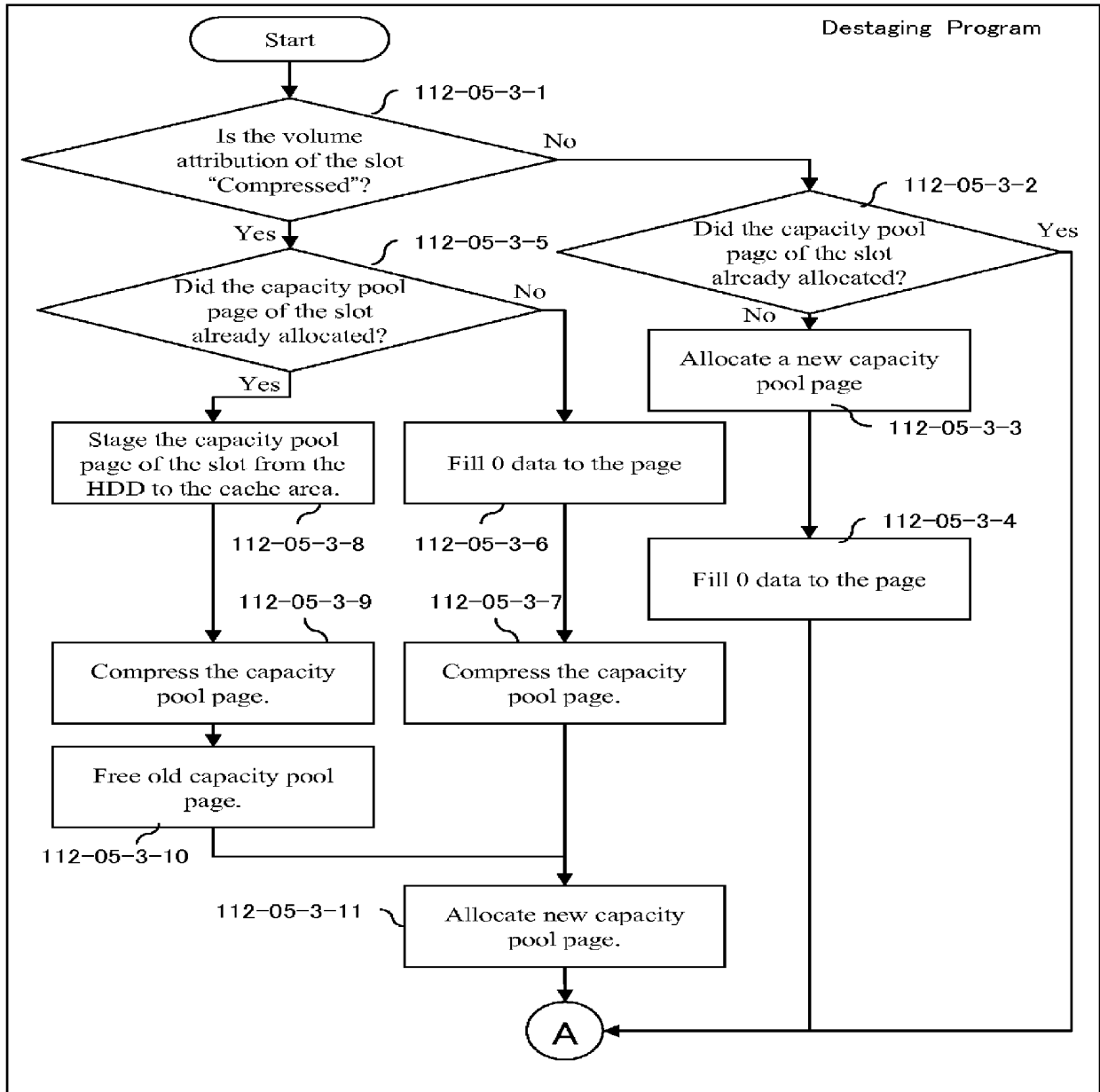

112-05-3

Fig. 31

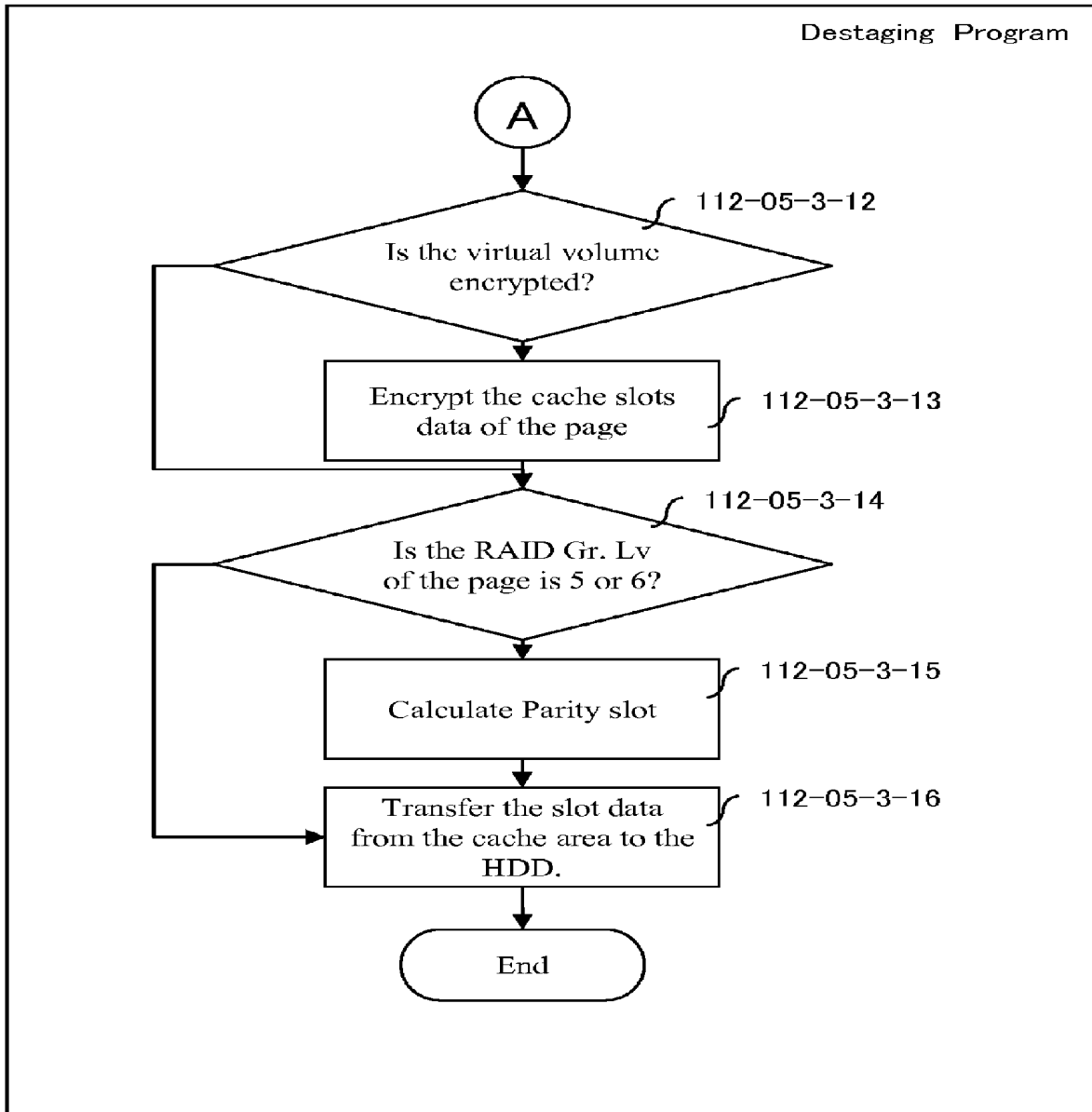

Fig. 32

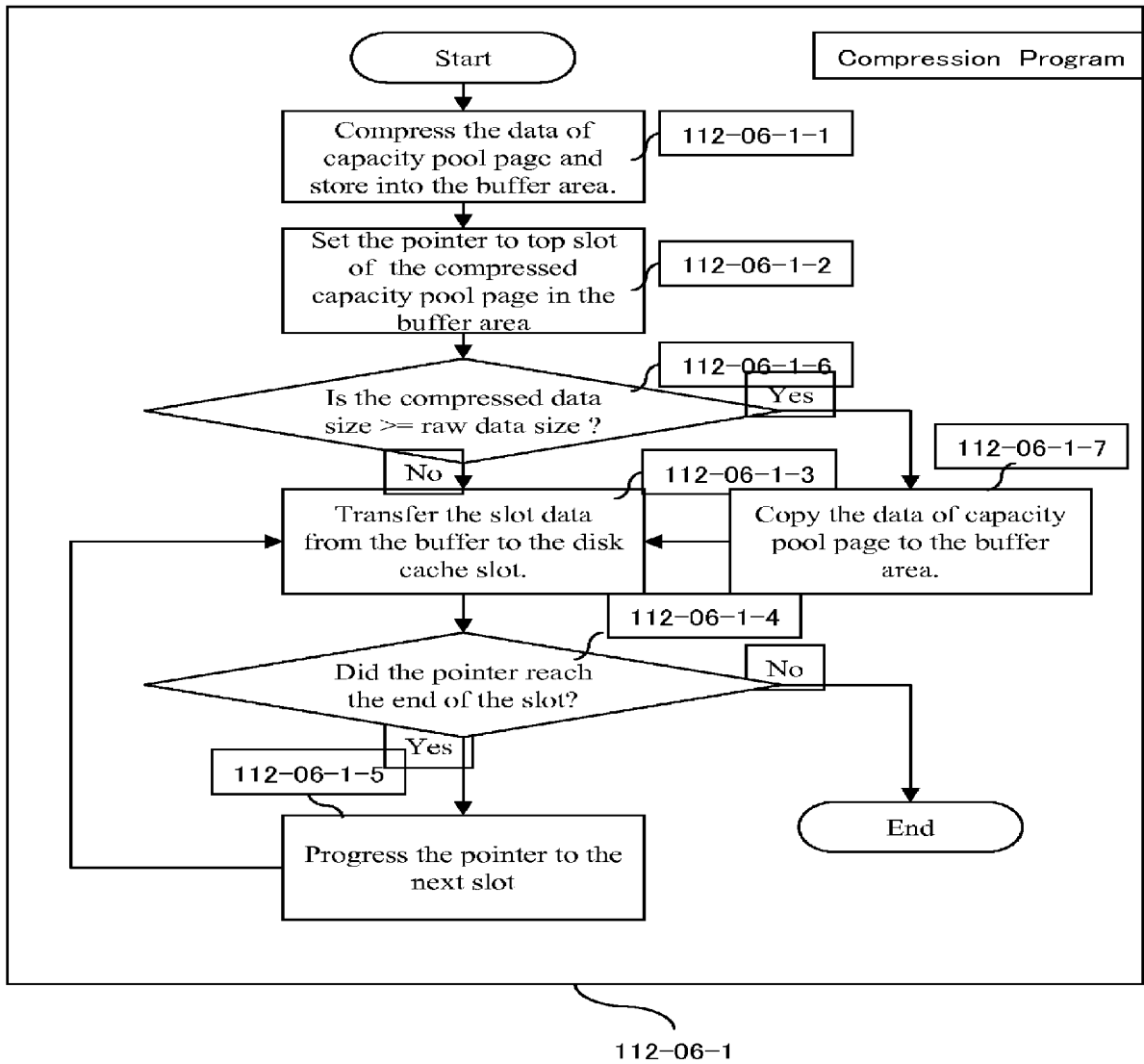

Fig. 33

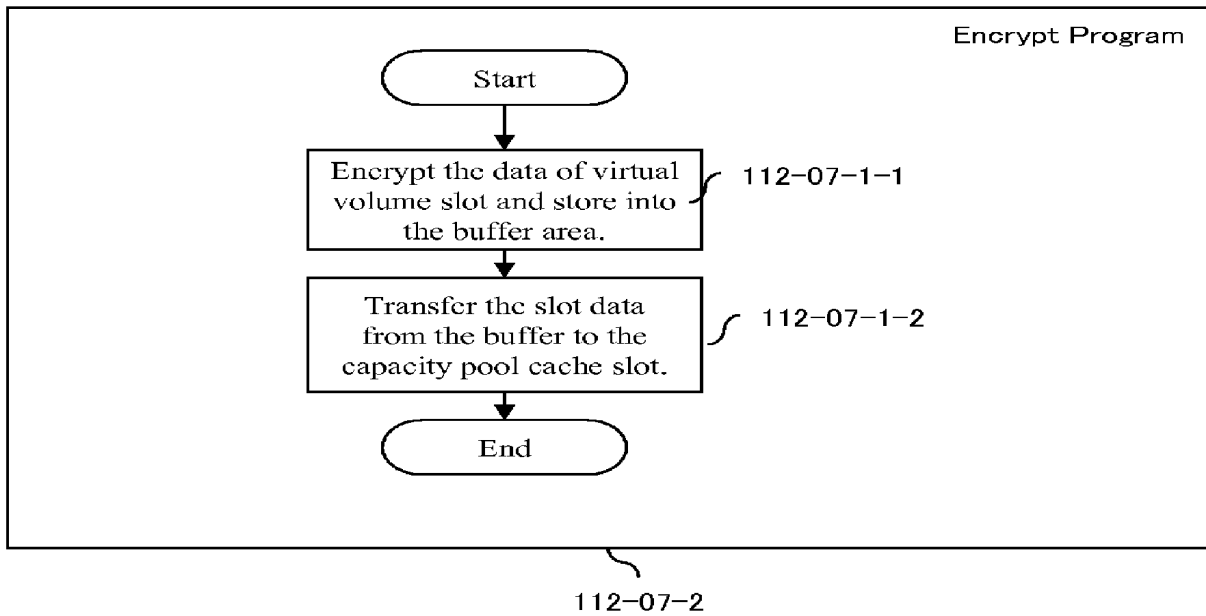

Fig. 34

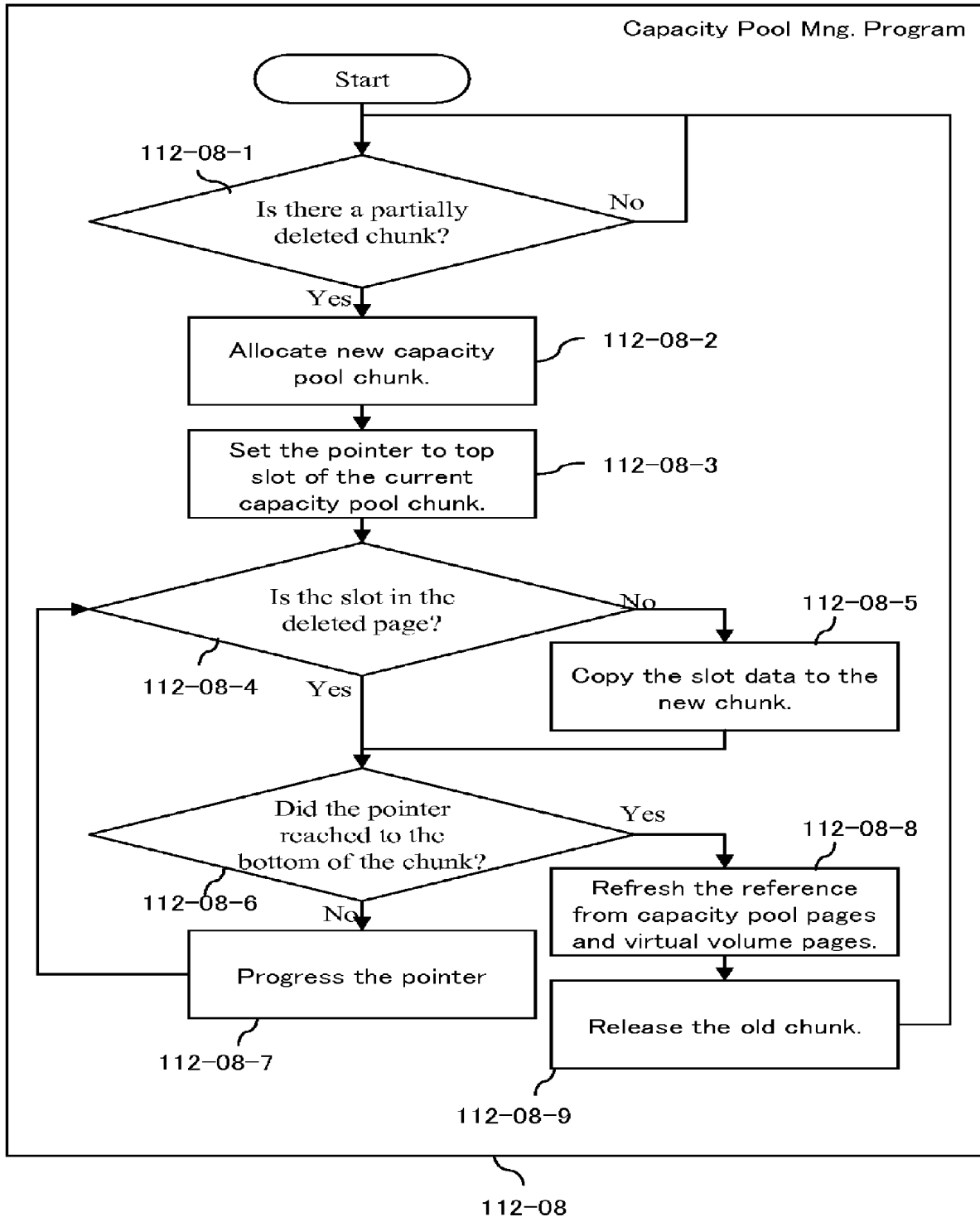

Fig. 35

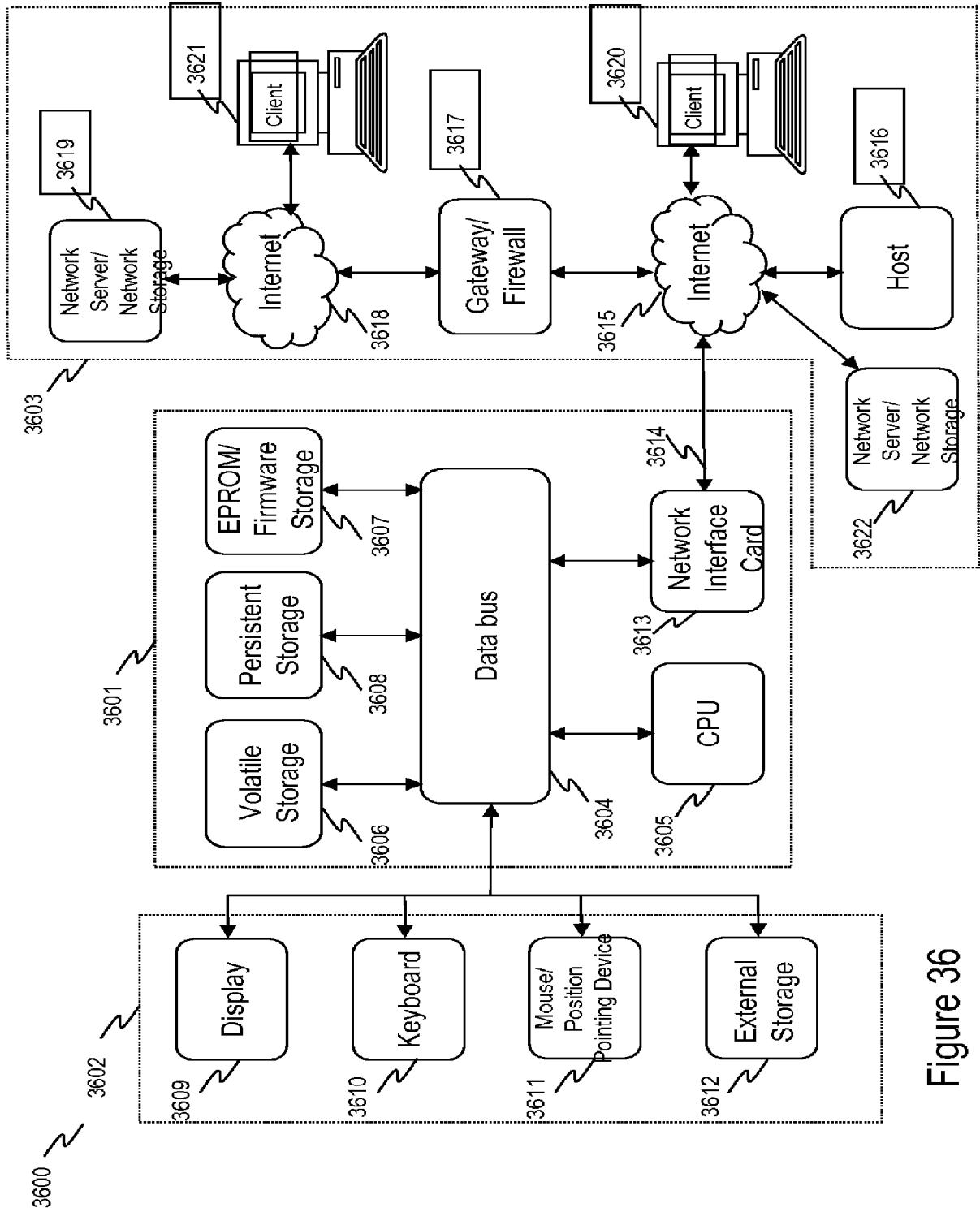

Figure 36



## FAST ACCESSIBLE COMPRESSED THIN PROVISIONING VOLUME

### CROSS-REFERENCES TO RELATED PATENT APPLICATIONS

This is a Continuation Application of application Ser. No. 11/948,948, filed Nov. 30, 2007 (now U.S. Pat. No. 8,131,927), the disclosure of which is incorporated herein in its entirety by reference.

### FIELD OF THE INVENTION

The present invention generally relates to storage technology and more specifically to storage systems incorporating one or more compressed data volumes.

### DESCRIPTION OF THE RELATED ART

Generally, it is desirable for a storage system to reduce waste of storage space on storing unnecessary and/or redundant information thereby reducing the size of the stored data. Storing only the necessary information increases the storage capacity available for storing important data thereby reducing overall storage costs. In the past, a number of approaches for reducing the size of the stored data have been developed.

One such solution includes a filesystem which is designed to automatically compress the data files that it manages. This approach is widely used in the art, for example in "Microsoft® Windows® NTFS". While this approach is very effective, it has one critical limitation, wherein the files compressed by one filesystem cannot be used in other filesystems because of differences in implementation of different filesystems.

Another solution is "thin provisioning", which is disclosed in U.S. Pat. No. 7,130,960, incorporated herein by reference in its entirety. The aforesaid thin provisioning technique also reduces the waste data by preventing allocation of any storage capacity to unwritten data area. This technology is applied at the block device level such that the implementation of thin provisioning is fully transparent to the filesystem. However, in many cases, thin provisioning volumes incorporate data areas filled with "0" data near the storage areas filled with useful information. Such "0"-filled data areas constitute a waste of storage capacity in the storage system.

On the other hand, low-level storage devices, such as tape drives, often incorporate a compression function. For example, a tape storage device can compress data when it transfers volume data stored in hard disk drives (HDDs) to a tape medium. But the aforesaid compression based volume data transfer is problematic when a part of the transferred data needs to be modified. To modify a part of the compressed volume data, one must first decompress the entire data volume, including unchanged data, then modify the necessary parts thereof and, finally, re-compress the entire volume again. This is because the compressed data cannot be modified directly without recompression. The aforesaid steps take long time to perform, preventing the transactional use of the data volume during the lengthy compression process. Systems using HDDs instead of tape devices suffer from the same problem as the tape medium.

Thus, the existing storage technology is deficient in its ability to effectively reduce the size of the stored data using compression and/or thin provisioning.

### SUMMARY OF THE INVENTION

The inventive methodology is directed to methods and systems that substantially obviate one or more of the above

and other problems associated with conventional techniques involving thin provisioning and data compression.

In accordance with one aspect of the inventive concept, there is provided a computerized data storage system. The inventive system incorporates at least one storage device having a nonvolatile writable medium; a cache memory operatively coupled to the storage port and having a data storing area and a data management controller; and a storage port. The storage port is configured to connect to a host computer and receive and send I/O information required by the host computer. The storage port is configured to receive requests to read and write data, and, in response to the request to read data, the storage port is configured to send the data stored in the data storing area of the cache memory and in response to a request to write data, the storage port is configured to send the write data to the data storing area of the cache memory. The inventive system further includes a thin provisioning controller configured to provide a virtual volume having a virtual volume page, a capacity pool having a capacity pool page and manage a mapping between the virtual volume page and the capacity pool page. The inventive system yet further includes a data compression controller configured to perform a compression operation on the virtual volume page, and a data decompression controller configured to perform a decompression operation on the virtual volume page.

In accordance with another aspect of the inventive concept, there is provided a method to be performed by a computerized data storage system. The inventive method involves: providing a virtual volume having a virtual volume page; providing a capacity pool having a capacity pool page; managing a mapping between the virtual volume page and the capacity pool page; providing a data caching area storing data; receiving a request to read data from a host computer, and, in response to the request to read data, sending to the host computer the data stored in the data caching area; receiving a request to write data from the host computer, and, in response to the request to write data, writing the write data provided by the host computer to the data caching area; performing a compression operation on the virtual volume page, and performing a decompression operation on the virtual volume page.

In accordance with yet another aspect of the inventive concept, there is provided a computer-readable medium embodying a set of instructions. The aforesaid set of instructions, when executed by a storage system comprising one or more processors, causes the storage system to: provide a virtual volume, the virtual volume comprising a virtual volume page; provide a capacity pool comprising a capacity pool page; manage a mapping between the virtual volume page and the capacity pool page; provide a data caching area storing data; receive a request to read data from a host computer, and, in response to the request to read data, send to the host computer the data stored in the data caching area; receive a request to write data from the host computer, and, in response to the request to write data, write the write data provided by the host computer to the data caching area; perform a compression operation on the virtual volume page, and perform a decompression operation on the virtual volume page.

Additional aspects related to the invention will be set forth in part in the description which follows, and in part will be obvious from the description, or may be learned by practice of the invention. Aspects of the invention may be realized and attained by means of the elements and combinations of various elements and aspects particularly pointed out in the following detailed description and the appended claims.

It is to be understood that both the foregoing and the following descriptions are exemplary and explanatory only and

are not intended to limit the claimed invention or application thereof in any manner whatsoever.

### BRIEF DESCRIPTION OF THE DRAWINGS

The accompanying drawings, which are incorporated in and constitute a part of this specification exemplify the embodiments of the present invention and, together with the description, serve to explain and illustrate principles of the inventive technique. Specifically:

FIG. 1 illustrates an exemplary system architecture of an embodiment of the inventive storage system

FIG. 2 illustrates an exemplary structure of the information stored in the Memory.

FIG. 3 illustrates an exemplary embodiment of a Volume Operation Program.

FIG. 4 illustrates an exemplary embodiment of an I/O Operation Program.

FIG. 5 illustrates an exemplary embodiment of a Disk Access Program.

FIG. 6 illustrates an exemplary embodiment of a Compression/Decompression Program.

FIG. 7 illustrates an exemplary embodiment of an Encryption/Decryption Program.

FIG. 8 illustrates an exemplary embodiment of a RAID Group Management Table.

FIG. 9 illustrates an exemplary embodiment of a Virtual Volume Management Table.

FIG. 10 illustrates an exemplary embodiment of a Virtual Volume Page Management Table.

FIG. 11 illustrates an exemplary embodiment of a Capacity Pool Management Table.

FIG. 12 illustrates an exemplary embodiment of a Capacity Pool Element Management Table.

FIG. 13 illustrates an exemplary embodiment of a Capacity Pool Chunk Management Table.

FIG. 14 illustrates an exemplary embodiment of a Capacity Pool Page Management Table.

FIG. 15 illustrates an exemplary embodiment of a Cache Management Table.

FIG. 16 illustrates the exemplary relationship of capacity pool chunk, capacity pool page and disk cache.

FIG. 17 illustrates the exemplary relationship of HDDs, RAID group, virtual volume page, virtual volume slot and virtual volume.

FIG. 18 illustrates the exemplary relationship of the Capacity Pool Management Table, the Capacity Pool Element Management Table, the Capacity Pool Chunk Management Table, the RAID Group Management Table and the Capacity Pool Chunks.

FIG. 19 illustrates the exemplary relationship of the Virtual Volume, the Virtual Volume Page, the Virtual Volume Management Table, the Virtual Volume Page Management Table, the Capacity Pool Management Table, the Capacity Pool Chunk, the Capacity Pool Page and the Capacity Pool Element Management Table.

FIG. 20 illustrates the exemplary relationship of the Virtual Volume, the Virtual Volume Page, the Capacity Pool Chunk, the Capacity Pool Page and the Capacity Pool Element Management Table.

FIG. 21 illustrates the exemplary relationship of the Cache Slot, the Cache Management Table and the Disk Slot.

FIG. 22 illustrates an exemplary embodiment of an operational flow chart of the Volume Operation Waiting Program.

FIG. 23 illustrates an exemplary embodiment of an operational flow chart of the Volume Compression Program.

FIG. 24 illustrates an exemplary embodiment of an operational flow chart of the Volume Decompression Program.

FIG. 25 illustrates an exemplary embodiment of an operational flow chart of the Write I/O Operation Program.

FIG. 26 illustrates an exemplary embodiment of an operational flow chart of the Read I/O Operation Program.

FIG. 27 illustrates an exemplary embodiment of an operational flow chart of the Cache Staging Program.

FIG. 28 illustrates an exemplary embodiment of an operational flow chart of the Decompression Program.

FIG. 29 illustrates an exemplary embodiment of an operational flow chart of the Decryption Program.

FIG. 30 illustrates an exemplary embodiment of an operational flow chart of the Disk Flushing Program.

FIG. 31 illustrates an exemplary embodiment of an operational flow chart of the Cache Destaging Program.

FIG. 32 illustrates an exemplary embodiment of an operational flow chart of the Cache Destaging Program.

FIG. 33 illustrates an exemplary embodiment of an operational flow chart of the Compression Program.

FIG. 34 illustrates an exemplary embodiment of an operational flow chart of the Encryption Program.

FIG. 35 illustrates an exemplary embodiment of an operational flow chart of the Capacity Pool Management Program.

FIG. 36 illustrates an exemplary embodiment of a computer platform upon which the inventive system may be implemented.

### DETAILED DESCRIPTION

In the following detailed description, reference will be made to the accompanying drawings, in which identical functional elements are designated with like numerals. The aforementioned accompanying drawings show by way of illustration, and not by way of limitation, specific embodiments and implementations consistent with principles of the present invention. These implementations are described in sufficient detail to enable those skilled in the art to practice the invention and it is to be understood that other implementations may be utilized and that structural changes and/or substitutions of various elements may be made without departing from the scope and spirit of present invention. The following detailed description is, therefore, not to be construed in a limited sense. Additionally, the various embodiments of the invention as described may be implemented in the form of a software running on a general purpose computer, in the form of a specialized hardware, or combination of software and hardware.

#### Storage System Components

FIG. 1 illustrates an exemplary system architecture of an embodiment of the inventive storage system. With reference to FIG. 1, an exemplary embodiment of a storage system consistent with principles of the inventive approach incorporates Storage Subsystem **100**, Storage Network **200** and Host Computer **300**. In one implementation, the Storage Subsystem **100** includes Storage Controller **110**, Disk Unit **120** and Management Terminal **130**. In one embodiment, the aforesaid Storage Controller **110** incorporates a CPU **111**, which executes various software programs. The programs and data tables used by the CPU **111** are stored in the Memory **112** of the Controller **110**. In one embodiment, the controller **110** further incorporates a Disk Interface **114**, which may be implemented as a SCSI interface. The Disk Interface **114** operates to connect Disk **120** to the Controller **110**. The controller **110** also incorporates Host Interface **115**, which may be implemented as a FibreChannel interface.

The Host Interface **115** operates to interconnect the Controller **110** with the Host Computer **300** via the Storage Network **200**. The Host Interface **115** receives I/O requests from the Host Computer **300** and provides the corresponding information to the CPU **111**. In one implementation, the Disk Controller **110** further incorporates Management Terminal Interface (e.g. NIC I/F) **116**. The Management Terminal Interface **116** connects the Disk Controller **110** with the Storage Controller Interface **133**. The aforesaid Management Terminal Interface **116** receives volume, disk and capacity pool operation requests from Management Terminal **130** and inform to CPU **111**.

The Disk Unit **120** incorporates one or more Disks **121**, which may be HDDs. The Management Terminal **130** may include a CPU **131**, which operates to manage various processes of the Management Terminal **130**, a Memory **132** and a Storage Controller Interface (NIC) **133**. The Storage Controller Interface **133** is connected to Management Terminal Interface **116** of the Disk Controller **110**. The Storage Controller Interface **133** sends information on the volume, disk and capacity pool operations to Storage Controller **110**. In one embodiment, the Management Terminal **130** further includes a User Interface **134**, which may be a Keyboard, Mouse, Monitor or the like devices.

FIG. 2 illustrates an exemplary structure of the information stored in the Memory **112**. In one implementation, the Memory **112** stores a Volume Operation Program **112-02**. The Volume Operation Program **112-02** includes a Volume Operation Waiting Program **112-02-1**, Volume Compression Program **112-02-2** and Volume Decompression Program **112-02-3**, illustrated in FIG. 3. The Volume Operation Waiting Program **112-02-1** executes when the CPU **111** receives a volume compression or decompression request. This program may be implemented as a system residence program. The Volume Compression Program **112-02-2** executes when the CPU **111** received a volume compression request. The Volume Compression Program **112-02-2** changes a thin provisioning volume to a compression volume using compression. The Volume Compression Program **112-02-2** is called by Volume Operation Waiting Program **112-02-1**.

The Volume Decompression Program **112-02-3** executes when the CPU **111** receives a volume decompression request. The Volume Decompression Program **112-02-3** changes a compression volume to a thin provisioning (decompression) volume using decompression. The Volume Operation Program **112-02-3** is called by Volume Operation Waiting Program **112-02-1**.

In one exemplary implementation, the Memory **112** further stores an I/O Operation Program **112-04**. The I/O Operation Program **112-04** consists of a Write I/O Operation Program **112-04-1** and a Read I/O Operation Program **112-04-2**, illustrated in FIG. 4. The Write I/O Operation Program **112-04-1** executes when the CPU **111** receives a write I/O request. The Write I/O Operation Program **112-04-1** transfers I/O data from the Host Computer **300** to the Cache Area **112-20** via the Host interface **115**. This program **112-04-1** may be implemented as a system residence program.

The Read I/O Operation Program **112-04-2** is executed when the CPU **111** receives a read I/O request. The Read I/O Operation Program **112-04-2** operates to transfer I/O data from the Cache Area **112-20** to the Host Computer **300**. The Read I/O Operation Program **112-04-2** may also be implemented as a system residence program.

In one exemplary implementation, the Memory **112** may also store a Disk Access Program **112-05**. The Disk Access Program **112-05** includes a Disk Flushing Program **112-05-1**, Cache Staging Program **112-05-2** and a Cache Destaging

Program **112-05-1**, illustrated in FIG. 5. The Disk Flushing Program **112-05-1** searches for dirty cache data and flushes it to Disk **121**. The Disk Flushing Program **112-05-1** is executed when the workload of the CPU **111** is relatively low. The Disk Flushing Program **112-05-1** may also be implemented as a system residence program.

The Cache Staging Program **112-05-2** operates to transfer data from Disk **121** to Cache Area **112-05-20**. The Cache Staging Program **112-05-2** is executed when the CPU **111** needs to access the data in the Disk **121**. The Cache Destaging Program **112-05-3** transfers data from the Cache Area. The Cache Destaging Program **112-05-2** is executed when the Disk Flushing Program **112-05-1** flushes dirty cache data to the Disk **121**.

In one exemplary implementation, the Memory **112** further stores Compression/Decompression Program **112-06**. The Compression/Decompression Program **112-06** includes a Compression Program **112-06-1** and Decompression Program **112-06-2**, illustrated in FIG. 6. The Compression Program **112-06-1** operates to compress data in the Cache Area **112-20**. The Compression Program **112-06-1** uses the Buffer Area **112-21** to temporarily store the compressed data. The Compression Program **112-06-1** is executed upon a call from the Cache Destaging Program **112-05-2**, when there is data that needs to be compressed. The Decompression Program **112-06-2** decompresses data in the Cache Area **112-20** and uses Buffer Area **112-21** to temporarily store the decompressed data. The Decompression Program **112-06-2** is executed upon a call from the Cache Staging Program **112-05-1**, when there is data that needs to be decompressed.

In one exemplary embodiment, the Memory **112** may further store an Encryption/Decryption Program **112-07**. In one implementation, the Encryption/Decryption Program **112-07** includes Encryption Program **112-07-1** and Decryption Program **112-07-2**, illustrated in FIG. 7. The Encryption Program **112-07-1** encrypts data in the Cache Area **112-20**. This program uses Buffer Area **112-21** to temporarily store the encrypted data. The Encryption Program **112-07-1** is executed upon a call from the Cache Destaging Program **112-05-2**, when there is data that needs to be encrypted.

When both Encryption Program **112-07-1** and Compression Program **112-06-1** are sequentially executed on the same data set, the Compression Program **112-06-1** is executed first and the Encryption Program **112-07-1** is executed second. The Decryption Program **112-07-2** decrypts data in the Cache Area **112-20**. This program uses Buffer Area **112-21** to temporarily store the decompressed data. The Decryption Program **112-07-2** is executed upon a call from the Cache Staging Program **112-05-1**, when there is data that needs to be decrypted. When both Decryption Program **112-07-2** and Decompression Program **112-06-2** are sequentially executed on the same dataset, the Decryption Program **112-07-2** is executed first and the Decompression Program **112-06-2** is executed second.

In one exemplary embodiment, the Memory **112** may further store a Capacity Pool Management Program **112-08**. The Capacity Pool Management Program **112-08** does garbage collection in capacity pools. The Capacity Pool Management Program **112-03** is executed when the workload of the CPU **111** is relatively low or the remaining capacity of the capacity pool is low. This program may be implemented as a system residence program.

In one exemplary embodiment, the Memory **112** may further store a RAID Group Management Table **112-11**. The aforesaid RAID Group Management Table **112-11** is illustrated in FIG. 8 and may include a RAID Group Number Information column **112-11-01** representing an ID of RAID

group in Storage Controller **110** as well as RAID Level Information column **112-11-02**. The information in the RAID Level Information column **112-11-02** carries information on the RAID level as well as RAID organization Information. The value of “10” in this column means “Mirroring and Striping”, the value “5” means “Parity Striping”, while the value “6” means “Double Parity Striping.” The value “N/A” means that the corresponding RAID group doesn’t exist.

The RAID Group Management Table **112-11** may further include HDD Number Information column **112-11-03**. This column stores ID list of Disks **121** grouped in the corresponding RAID group. The RAID Group Management Table **112-11** may further include HDD Capacity Information column **112-11-04**, storing information on minimum capacity of the Disk **121** of the corresponding RAID group.

The Memory **112** may further store a Virtual Volume Management Table **112-12**. The Virtual Volume Management Table **112-12** is illustrated in FIG. **9** and may include a Volume Number Information column **112-12-01** storing ID of the corresponding virtual volume in Storage Controller **110**. The table **112-12** may further include a Volume Capacity Information column **112-12-02** storing the information on the capacity of the respective virtual volume. The table **112-12** may further include a Capacity Pool Number Information column **112-12-03** storing a Capacity Pool Number corresponding to the respective virtual volume. Each virtual volume is allocated data storage capacity from this capacity pool. The table **112-12** may further incorporate the Volume Type Information column **112-12-04** storing virtual volume type information. The value “Thin Provisioning” in this column means that the virtual volume is a normal thin provisioning volume. “Compressed” means that the corresponding virtual volume is a thin provisioning volume having compressed pages. “Encrypted” means that the corresponding virtual volume is a thin provisioning volume having encrypted pages. “Compressed & Encrypted” means that the corresponding virtual volume is a thin provisioning volume having pages that are compressed and encrypted. Finally, “N/A” means that the corresponding virtual volume doesn’t exist.

The aforesaid table **112-12** may further include Current Using Chunk Information column **112-12-05** storing information on chunks that the virtual volume has received from the respective capacity pool specified in the Capacity Pool Number Information column **112-12-03**. As one of ordinary skill in the art would appreciate, each virtual volume receives capacity pool pages from the pool chunk.

In one implementation, the Memory **112** also stores Virtual Volume Page Management Table **112-13**. The Virtual Volume Page Management Table **112-13** is illustrated in FIG. **10** and may include a Virtual Volume Page Address column **112-13-01** specifying ID of the virtual volume page in the corresponding virtual volume. The table **112-13** may further include Related RAID Group Number column **112-13-02** specifying the RAID group number of the allocated capacity pool page. The value “N/A” in this column indicates that the virtual volume page doesn’t allocate a capacity pool page.

The table **112-13** may further include a Capacity Pool Page Address column **112-13-03** storing a Logical address of the corresponding capacity pool page. And in particular the start address of the capacity pool page. The table **112-13** may further include Capacity Pool Page Size column **112-13-04** storing information on the size of the corresponding capacity pool page. If the capacity pool size is the same as the default size, it indicates that the virtual volume page isn’t compressed.

In one implementation, the Memory **112** also stores Capacity Pool Management Table **112-14**. The Capacity Pool Man-

agement Table **112-14** is illustrated in FIG. **11** and may include a Capacity Pool Number column **112-14-01** storing ID of the capacity pool in the Storage Controller **110**. The table **112-14** may further include a RAID Group List column **112-14-02** storing a list of RAID groups that are included into the capacity pool. The value “N/A” in this column means that the respective capacity pool doesn’t exist. The table **112-14** may further include a Free Capacity Information column **112-14-03** storing information on storage capacity of the entire free area in the capacity pool.

In one implementation, the Memory **112** also stores a Capacity Pool Element Management Table **112-15**. The Capacity Pool Element Management Table **112-15** is illustrated in FIG. **12** and may include a RAID Group Number column **112-15-01** storing an ID of the corresponding RAID group in the Storage Controller **110**. The table **112-15** may further include a Capacity Pool Number column **112-15-02** storing the ID of the Capacity pool that the corresponding RAID Group belongs to.

The table **112-15** may further include a Free Chunk Queue Index column **112-15-03** storing the Free chunk queue index number. In an embodiment of the inventive storage system, the RAID Group manages the free chunks as a queue. The table **112-15** may further include a Used Chunk Queue Index column **112-15-04** storing used chunk queue index number. In one embodiment of the inventive storage system, the RAID Group manages the used chunks as a queue.

In one implementation, the Memory **112** also stores Capacity Pool Chunk Management Table **112-16**. The Capacity Pool Chunk Management Table **112-16** is illustrated in FIG. **13** and includes a Chunk Number column **112-16-01** storing an ID of the chunk in the RAID group. The table **112-16** may further include a Virtual Volume Number column **112-16-02** storing the number of the virtual volume that uses the capacity pool chunk.

The table **112-16** may further include a Used Capacity Information column **112-16-03** storing information on total used capacity of the capacity pool chunk. When a virtual volume gets a capacity pool page from the capacity pool chunk, this parameter is increased by the capacity pool page size.

The table **112-16** may further include a Deleted Capacity Information column **112-16-04** storing information on total deleted capacity from the capacity pool chunk. When a virtual volume releases a capacity pool page by volume format or virtual volume page reallocation, this parameter is increased by the capacity of the pool page size.

The table **112-16** may further include a Next Chunk Pointer column **112-16-05** storing a Pointer of the other capacity pool chunk. In an embodiment of the inventive storage system, the capacity pool chunks have a queue structure. The values in the Free Chunk Queue Index column **112-15-03** and Used Chunk Queue Index column **112-15-04** are the indexes of the aforesaid queue.

In one implementation of the invention, the Memory **112** also stores Capacity Pool Page Management Table **112-17**. The Capacity Pool Page Management Table **112-17** is illustrated in FIG. **14** and includes a Capacity Pool Page Size column **112-17-01** storing information on the size of the corresponding capacity pool page. This parameter is stored when the capacity page is allocated to the virtual volume page. The value “N/A” in this column indicates the end of the capacity pool page list. The total size that the value in the Capacity Pool Page Size column **112-17-01** represents equals to sum of allocated and deleted size that is written in Used Capacity Information column **112-16-03** and Deleted Capacity Information column **112-16-04**.

The table **112-17** may further include a Virtual Volume Page Number column **112-17-02** storing virtual volume page number that corresponds to the capacity pool page. The value “NULL” in this column indicates a deleted page, when the value in the Capacity Pool Page Size column **112-17-01** is not “N/A”.

In one implementation of the invention, the Memory **112** also stores Cache Management Table **112-18**. The Cache Management Table **112-18** is illustrated in FIG. **15** and includes a Cache Slot Number column **112-18-01** storing the ID of the cache slot in Cache Area **112-20**. In one implementation of the invention, the Memory **112** includes a Cache Area **112-20**, which may include multiple cache slots. The table **112-18** may also include a Disk Number column **112-18-02** storing information on the Disk **121** or Virtual Volume **140** number corresponding to the data stored in the cache slot. The value in the Disk Number column **112-18-02** can identify the related Disk **121** or Virtual Volume **140**.

The Disk Address column **112-18-03** of the table **112-18** stores Disk address corresponding to the data stored in the cache slot. The Next Slot Pointer column **112-18-04** stores a Next cache slot number. In an embodiment of the inventive system, cache slots have a queue structure. The value “NULL” in the aforesaid column indicates the end of the queue.

The Kind of Queue Information column **112-18-11** stores information on the type of cache slot queue. The value “Free” in this column indicates the queue that has the unused cache slots. The value “Clean” indicates a queue that incorporates cache slots that stores the same data as the disk slots. The value “Dirty” indicates a queue that incorporates cache slots that stores data different from the data stored in the disk slots. Thus, the Storage Controller **110** needs to flush the cache slot data to the disk slot in the future. Finally, a Queue Index Pointer column **112-18-12** of the table **112-18** stores a value of the index of the cache slot queue.

As mentioned hereinabove, the Memory **112** incorporates a Cache Area **112-20**. This area may include multiple Cache Slots **112-20-1**, as shown in FIG. **21**. The Cache Slots **112-20-1** are managed by Cache Management Table **112-18**. The Memory **112** may also incorporate a Buffer Area **112-21**. The Buffer Area **112-21** provides temporary storage for work data.

#### Logical Structure

Now, the logical structure of the Storage Subsystem **100** will be described in detail. FIG. **16** illustrates the relationship of the capacity pool chunk, capacity pool page and disk cache. The Capacity Pool Chunk **121-1** consists of plural Disk Slots **121-3** in a RAID group. The Capacity Pool Chunk **121-1** can have 0 or more Capacity Pool Pages **121-2** in it. In an embodiment of the invention, the size of Capacity Pool Chunk **121-1** is fixed. A capacity Pool Page **121-2** consists of plural disk slots in a RAID group. The capacity Pool Page **121-2** can have 1 or more Disk Slots **121-3** in it. In an embodiment of the invention, the size of Capacity Pool Page **121-2** is variable. The Disk Slot **121-3** represents a stripe block of the RAID structure. In an embodiment of the invention, the size of Disk Slot **121-3** is fixed and is the same as the Cache Slot **112-20-1** size. The Disk Slot stores host data or parity data.

FIG. **17** illustrates the relationship of virtual volume page, virtual volume slot and virtual volume. The Virtual Volume **140** will now be described. The Host Computer **300** accesses the Virtual Volume **140** by means of I/O operations. The Virtual Volume **140** is allocated storage capacity from the capacity pool and includes one or more Virtual Volume Slots **140-2**. The Virtual Volume **140** is allocated storage resources using a Virtual Volume Page **140-1**. The Virtual Volume Page

**140-1** includes one or more Virtual Volume Slots **140-2**. The Virtual Volume Slot **140-2** has the same capacity as the Cache Slot **112-20-1** and Disk Slot **121-3**.

FIG. **18** illustrates the relationship of Capacity Pool Management Table **112-14**, Capacity Pool Element Management Table **112-15**, Capacity Pool Chunk Management Table **112-16**, RAID Group Management Table **112-11** and Capacity Pool Chunks **121-1**. Dashed line in FIG. **18** indicates a reference by pointer, while the solid line indicates reference by calculation. The Capacity Pool Management Table **112-14** references the Capacity Pool Element Management Table **112-15** using RAID Group List column **112-14-02**. The Capacity Pool Element Management Table **112-15** references the Capacity pool Management Table **112-14** using Capacity Pool Number column **112-15-02**. Capacity Pool Element Management Table **112-15** references Capacity Pool Chunk Management Table **112-16** using Free Chunk Queue column **112-15-03** and Used Chunk Queue column **112-15-04**. The relationship of Capacity Pool Element Management Table **112-15** and RAID Group Management Table **112-11** is fixed. The relationship of Capacity Pool Chunk **121-1** and Capacity Pool Chunk Management Table **112-15** is also fixed.

FIG. **19** illustrates the relationship of the Virtual Volume **140**, the Virtual Volume Page **140-1**, the Virtual Volume Management Table **112-12**, the Virtual Volume Page Management Table **112-13**, the Capacity Pool Management Table **112-14**, the Capacity Pool Chunk **121-1**, the Capacity Pool Page **121-2** and the Capacity Pool Element Management Table. In that figure, a dashed line indicates a reference by pointer, while a solid line indicates a reference by calculation.

The Virtual Volume Management Table **112-12** references the Capacity Pool Management Table **112-14** using the Capacity Pool Number Information column **112-12-03**. The Virtual Volume Management Table **112-12** references the allocated Capacity Pool Chunk **121-1** using Current Using Chunk Information column **112-12-05**. The Capacity Pool Management Table **112-14** references the RAID group using the RAID Group List column **112-14-02**. The Virtual Volume Page Management Table **112-13** references the Virtual Volume Page **121-2** using the Capacity Pool Page Address column **112-13-03** and Capacity Pool Page Size column **112-13-04**.

The relationship of the Virtual Volume **140** and the Virtual Volume Management Table **112-12** is fixed. The relationship of Virtual Volume Management Table **112-12** and the Virtual Volume Page Management Table **112-13** is also fixed. The relationship of the Virtual Volume Page **140-1** and the Virtual Volume Page Management Table **112-13** is likewise fixed.

FIG. **20** illustrates the relationship of the Virtual Volume **140**, the Virtual Volume Page **140-1**, the Capacity Pool Chunk **121-1**, the Capacity Pool Page **121-2** and the Capacity Pool Element Management Table. As in the previous figures, in this figure, a dashed line indicates a reference by pointer, while a solid line indicates a reference by calculation. The Capacity Pool Chunk Management Table **112-16** references the Virtual Volume **140** using Virtual Volume Number column **112-16-02**. The Capacity Pool Page Management Table **112-17** references the Virtual Volume Page **140-1** using Virtual Volume Page Number column **112-17-02**.

In an embodiment of the inventive system, the relationship of the Capacity Pool Chunk **121-1** and the Capacity Pool Chunk Management Table **112-16** is fixed. In an embodiment of the invention, the Capacity Pool Page Management Table **112-17** related to Capacity Pool Page **121-2** is found by seeking Capacity Pool Page Management Table **112-17**.

FIG. **21** illustrates the relationship of the Cache Slot **112-20-1**, the Cache Management Table **112-16** and the Disk Slot

## 11

121-3. As in the previous figures, a dashed line indicates a reference by pointer, while a solid line indicates a reference by calculation. The Cache Management Table 112-18 references the Disk Slot 121-3 using the Disk Number column 112-18-02 and the Disk Address column 112-18-03. In an embodiment of the invention, the relationship of Cache Management Table 112-18 and Cache Slot 112-20-1 is fixed.

Operational Flow Chart of the Storage System

FIG. 22 illustrates an exemplary embodiment of an operational flow chart of the Volume Operation Waiting Program 112-02-1. The Volume Operation Waiting Program 112-02-1 includes one or more of the following steps.

At Step 112-02-1-1, the CPU 111 checks whether a volume operation request has been received. If it is determined that the CPU 111 has received the aforesaid request, the CPU 111 proceeds to Step 112-02-1-2. If the CPU 111 has not received the request, the CPU 111 repeats the Step 112-02-1-1.

At Step 112-02-1-2, the CPU 111 checks the type of the received request. If the CPU 111 received a "Change to Compress Volume" request, then the CPU 111 proceeds to Step 112-02-1-3. If the CPU 111 didn't receive the "Change to Compress Volume" request, then the CPU 111 proceeds to Step 112-02-1-4.

At Step 112-02-1-3, the CPU 111 calls Volume Compression Program 112-02-2 in order to compress the volume. After the completion of the Step 112-02-1-3, the CPU 111 returns to the Step 112-02-1-1.

At Step 112-02-1-4, the CPU 111 again checks the type of the received request. If the CPU 111 received a "Change to Decompress Volume" request, then the CPU 111 proceeds to Step 112-02-1-5. If the CPU 111 has not received the "Change to Decompress Volume" request, then the CPU 111 returns to the Step 112-02-1-1.

At Step 112-02-1-5, the CPU 111 calls the Volume Decompression Program 112-02-3 in order to decompress the volume. After the completion of the Step 112-02-1-5, the CPU 111 returns to the Step 112-02-1-1.

FIG. 23 illustrates an exemplary embodiment of an operational flow chart of the Volume Compression Program 112-02-2. Upon invocation of this program, it is provided with a volume number for compression. The Volume Compression Program 112-02-2 may include one or more of the following steps.

At Step 112-02-2-1, the CPU 111 checks whether or not the target volume is already compressed. If the value in the Volume Type Information column 112-12-04 corresponding to the target volume is "Thin Provisioning" or "Encrypted" then the CPU 111 proceeds to Step 112-02-2-2. If the corresponding value in the Volume Type Information column 112-12-04 is not "Thin Provisioning" or "Encrypted", then the CPU 111 terminates the execution of the Volume Compression Program 112-02-2.

At Step 112-02-2-2, the CPU 111 sets the value of the virtual volume pointer to the top of the target virtual volume. Specifically, the pointer is set to the first page of the virtual volume. After that, the CPU 111 proceeds to Step 112-02-2-6.

At Step 112-02-2-6, the CPU 111 calls the Cache Staging Program 112-05-2 in order to stage the page data 121 referenced by the aforesaid pointer from the HDDs. After the completion of the Step 112-02-2-6, the CPU 111 proceeds to Step 112-02-2-3.

At Step 112-02-2-3, the CPU 111 calls the Compression Program 112-06-1 in order to compress the page referenced by the aforesaid pointer. After the completion of the Step 112-02-2-3, the CPU 111 proceeds to the Step 112-02-2-4.

At Step 112-02-2-4, the CPU 111 checks whether or not the pointer has reached the end page of the virtual volume. If the

## 12

pointer points to the aforesaid end page, then the CPU 111 terminates the execution of the Volume Compression Program 112-02-2. If the pointer does not point to the end page, then the CPU 111 proceeds to the Step 112-02-2-5.

At Step 112-02-2-5, the CPU 111 sets the pointer to point to the next page of the virtual volume.

FIG. 24 illustrates an exemplary embodiment of an operational flow chart of the Volume Decompression Program 112-02-3. When the aforesaid program is invoked, it is provided with a volume number to be decompressed. The Volume Decompression Program 112-02-3 may include one or more of the following steps.

At Step 112-02-3-1, the CPU 111 checks whether or not the target volume has already been decompressed. If the value in the Volume Type Information column 112-12-04 corresponding to the target volume is "Compressed" or "Encrypted & Compressed", then the CPU 111 proceeds to Step 112-02-3-2. If the corresponding value in the Volume Type Information column 112-12-04 is not "Compressed" or "Encrypted & Compressed", then the CPU 111 terminates the Volume Decompression Program 112-02-3.

At Step 112-02-3-2, the CPU 111 sets the pointer to first page of the virtual volume. Then, the CPU 111 proceeds to Step 112-02-3-3.

At Step 112-02-3-3, the CPU 111 decompresses the page pointed to by the pointer. To this end, the CPU 111 calls Decompression Program 112-06-2 to decompress the page. After the completion of the Step 112-02-3-3, the CPU 111 proceeds to the Step 112-02-3-4.

At Step 112-02-3-4, the CPU 111 checks whether or not the pointer has reached the end page of the virtual volume. If it is determined that the pointer points to the end page of the virtual volume, then the CPU 111 terminates the Volume Compression Program 112-02-3. If the pointer does not point to the end page of the virtual volume, then the CPU 111 proceeds to the Step 112-02-3-5.

At Step 112-02-3-5, the CPU 111 re-sets the pointer to point to the next page of the virtual volume.

FIG. 25 illustrates an exemplary embodiment of an operational flow chart of the Write I/O Operation Program 112-04-1. An embodiment of the Write I/O Operation Program 112-04-1 may include one or more of the following steps.

At Step 112-04-1-1, the CPU 111 checks whether or not a write I/O request has been received. If CPU 111 determines that the request has been received, then the CPU 111 proceeds to Step 112-04-1-2. If CPU 111 did not receive the request, then the CPU 111 repeats the Step 112-04-1-1.

At Step 112-04-1-2, the CPU 111 searches a record in the Cache Management Table 112-20 referenced by the "Clean" or "Dirty" queue to locate Cache Slot 112-20-1 of the I/O. If CPU finds the appropriate Cache Slot 112-20-1, then the CPU 111 proceeds to Step 112-04-1-4. If CPU does not find the Cache Slot 112-20-1, then the CPU 111 proceeds to Step 112-04-1-3.

At Step 112-04-1-3, the CPU 111 obtains a Cache Slot 112-20-1 that is linked to the "Free" queue of the Cache Management Table 112-20. After that, the CPU 111 proceeds to Step 112-04-1-4.

At Step 112-04-1-4, the CPU 111 transfers the write I/O data to the Cache Slot 112-20-1 from the Host Computer 300. After that, the CPU 111 returns to the Step 112-04-1-1.

FIG. 26 illustrates an exemplary embodiment of an operational flow chart of the Read I/O Operation Program 112-04-2. The exemplary embodiment of the Read I/O Operation Program 112-04-2 may include one or more of the following steps.

## 13

At Step 112-04-2-1, the CPU 111 checks whether or not a read I/O request has been received. If CPU 111 determines that the aforesaid request has been received, then the CPU 111 proceeds to Step 112-04-2-2. If the CPU 111 did not receive the request, then the CPU 111 repeats the Step 112-04-2-1.

At Step 112-04-2-2, the CPU 111 searches the records of the Cache Management Table 112-20 linked to “Clean” or “Dirty” queue to find Cache Slot 112-20-1 of the I/O request. If the CPU successfully finds the Cache Slot 112-20-1, then the CPU 111 proceeds to Step 112-04-1-6. If CPU could not find the Cache Slot 112-20-1, then the CPU 111 proceeds to Step 112-04-1-3.

At Step 112-04-2-3, the CPU 111 obtains a Cache Slot 112-20-1 that is linked to “Free” queue of Cache Management Table 112-20. After that, the CPU 111 proceeds to Step 112-04-2-4.

At Step 112-04-2-4, the CPU 111 finds the Capacity Pool Page 121-2 referenced by the Virtual Volume Page by searching the Virtual Volume Page Management Table 112-13. After that, the CPU 111 proceeds to Step 112-04-2-5.

At Step 112-04-2-5, the CPU 111 invokes the Cache Staging Program 112-05-2 in order to transfer the data from the Disk Slot 121-3 to the Cache Slot 112-20-1. After the completion of the Step 112-04-2-5, the CPU 111 proceeds to Step 112-04-2-6.

At Step 112-04-2-6, the CPU 111 transfers the read I/O data from the Cache Slot 112-20-1 to the Host Computer 300. After that, the CPU 111 returns to the Step 112-04-2-1.

FIG. 27 illustrates an exemplary embodiment of an operational flow chart of the Cache Staging Program 112-05-2. When this program is invoked, it is provided with a staging (transfer from disk to cache memory) slot information. The Cache Staging Program 112-05-2 may include one or more of the following steps.

At Step 112-05-2-1, the CPU 111 checks whether or not the page has been compressed. If the value in the Capacity Pool Page Size column 112-13-04 indicates a default page size, the CPU 111 determines that that the page has been compressed. If the page has been compressed, then the CPU 111 proceeds to Step 112-05-2-5. If the page has not been compressed, then the CPU 111 proceeds to Step 112-05-2-2.

At Step 112-05-2-2, the CPU 111 transfers the slot data from the Disk Slot 121-3 to the Cache Slot 112-20-1. After that, the CPU 111 proceeds to Step 112-05-2-3.

At Step 112-05-2-3, the CPU 111 checks whether or not the page has been encrypted. Specifically, if the corresponding value in the Volume Type Information column 112-12-04 is “Encrypted” or “Encrypted & Compressed”, then the CPU 111 determines that the page has been encrypted. If the page has been encrypted, then the CPU 111 proceeds to Step 112-05-2-4. If the page has not been encrypted, then the CPU 111 terminates the Cache Staging Program 112-05-2.

At Step 112-05-2-4, the CPU calls the Decryption Program 112-07-2 in order to decrypt the slot. After the completion of the Step 112-05-2-4, the CPU 111 terminates the Cache Staging Program 112-05-2.

At Step 112-05-2-5, the CPU 111 searches the Cache Management Table 112-18 for the Cache Slots 112-20-1 of the page that the slot belongs to, and the CPU 111 obtains cache slots for the slots that are not in the Cache Management Table 112-18. After that, the CPU 111 transfers all slots of the page that the slot belongs to from Disk Slots 121-3 to Cache Slot 112-20-1. After that, the CPU 111 proceeds to the Step 112-05-2-6.

At Step 112-05-2-6, the CPU 111 checks whether or not the page has been encrypted. If the value in the corresponding Volume Type Information column 112-12-04 is “Encrypted”

## 14

or “Encrypted & Compressed”, then the CPU 111 determines that the page has been encrypted. If the page has been encrypted, then the CPU 111 proceeds to Step 112-05-2-7. If the page has not been encrypted, then the CPU 111 terminates the Cache Staging Program 112-05-9.

At Step 112-05-2-7, the CPU 111 invokes the Decryption Program 112-07-2 in order to decrypt the page that the slot belongs to. After the completion of the Step 112-05-2-4, the CPU 111 proceeds to Step 112-05-2-8.

At Step 112-05-2-8, the CPU 111 calls the Decompression Program 112-06-2 in order to decompress the page that the slot belongs to. After the completion of the Step 112-05-2-8, the CPU 111 terminates the Cache Staging Program 112-05-2.

FIG. 28 illustrates an exemplary embodiment of an operational flow chart of the Decompression Program 112-06-2. Upon its invocation, the Decompression Program 112-06-2 is provided with a page for decompression. The Decompression Program 112-06-2 may include one or more of the following steps.

At Step 112-06-2-1, the CPU 111 reads the Cache Slots 112-20-1 of the page. After that, the page is being decompressed and stored in the Buffer Area 112-21. Then, the CPU 111 proceeds to Step 112-06-2-2.

At Step 112-06-2-2, the CPU 111 sets a pointer to the first slot number of the decompressed page in Buffer Area 112-21. After that, the CPU 111 proceeds to Step 112-06-2-3.

At Step 112-06-2-3, the CPU 111 searches the Cache Management Table 112-18 and determines whether the Virtual Volume 140 has a Cache Slot 112-20-1 that relates to the decompressed slot. If the Virtual Volume 140 has a Cache Slot 112-20-1 that relates to the decompressed slot, then the CPU proceeds to Step 112-06-2-4. If the Virtual Volume 140 does not have a Cache Slot 112-20-1 that relates to the decompressed slot, then the CPU 111 proceeds to Step 112-06-2-5.

At Step 112-06-2-4, the CPU 111 transfers the decompressed slot from the Buffer Area 112-21 to the related Cache Slot 112-20-1 of the Virtual Volume Slot 140-2. After that, the CPU 111 proceeds to Step 112-06-2-5.

At Step 112-06-2-5, the CPU 111 determines whether the pointer reached the last slot of the decompressed page in the Buffer Area 112-21. If the pointer has reached the last slot, then the CPU 111 terminates the Decompress Program 112-06-2. If the pointer has not reached the last slot, then the CPU 111 proceeds to Step 112-06-2-6.

At Step 112-06-2-6, the CPU 111 sets the pointer to the next slot. After that, the CPU 111 returns to Step 112-06-2-3.

FIG. 29 illustrates an exemplary embodiment of an operational flow chart of the Decryption Program 112-07-2. When the program is invoked, it is provided with a slot for decryption. The Decryption Program 112-07-2 may include one or more of the following steps.

At Step 112-07-2-1, the CPU 111 reads the Cache Slot 112-20-1 of the Disk Slot 121-3, decrypts the page, and stores it in the Buffer Area 112-21. After that, the CPU 111 proceeds to Step 112-07-2-2.

At Step 112-07-2-2, the CPU 111 copies the decrypted slot in Buffer Area 112-21 to the Cache Slot 112-20-1 of the Virtual Volume Slot 121-3. After that, the CPU 111 terminates the Decryption Program 112-07-2.

FIG. 30 illustrates an exemplary embodiment of an operational flow chart of the Disk Flushing Program 112-05-1. The Disk Flushing Program 112-05-1 may include one or more of the following steps.

## 15

At Step **112-05-1-1**, the CPU **111** searches “Dirty” queue of Cache Management Table **112-18** and obtains the first slot of the queue. After that, the CPU **111** proceeds to Step **112-05-1-2**.

At Step **112-05-1-2**, the CPU calls the Cache Destaging Program **112-05-3**. After the completion of the Step **112-05-1-2**, the CPU **111** returns to Step **112-05-1-1**.

FIGS. **31** and **32** illustrate exemplary embodiments of an operational flow charts of the Cache Destaging Program **112-05-3**. Upon invocation of this program, it is provided with a destaging (transfer to cache memory from disk) slot. In one embodiment of the invention, the Cache Destaging Program **112-05-3** may include one or more of the following steps.

At Step **112-05-3-1**, the CPU **111** checks whether or not the page of the slot needs to be compressed. If the corresponding value in the Volume Type Information column **112-12-04** is “Compressed” or “Encrypted & Compressed”, the CPU **111** determines that the page of the slot needs to be compressed. If the page of the slot needs to be compressed, then the CPU **111** proceeds to Step **112-05-3-5**. If the page of the slot does not need to be compressed, then the CPU **111** proceeds to Step **112-05-3-2**.

At Step **112-05-3-2**, the CPU **111** checks the Virtual Volume Page Management Table **112-13** to determine whether or not the page of the slot has already been allocated. If the page has already been allocated, then the CPU **111** proceeds to Step **112-05-3-12**. If the page has not been allocated yet, then the CPU **111** proceeds to Step **112-05-3-3**.

At Step **112-05-3-3**, the CPU **111** reads the record in the Capacity Pool Page Management table **112-17** that is referenced by the Current Using Chunk Information **112-12-05**. After that, the CPU **111** registers the Virtual Volume Page **140-1** into the Current Using Chunk Information **112-12-05**. The size of the virtual volume page is determined by the value of the Virtual Volume Page **140-1** record. If the free area of the Virtual Volume Page **140-1** that Current Using Chunk Information **112-12-05** refers to is less than Virtual Volume Page **140-1** size, then the CPU **111** links this Virtual Volume Page **140-1** to “Used Chunk Queue” of Capacity Pool Element Management Table **112-15**, and obtains a new one form the “Free Chunk Queue”. After that, the CPU **111** registers the Capacity Pool Page **121-2** into the Virtual Volume Page Management table **112-13**. The size of the page is determined by the corresponding value in the Virtual Volume Page **140-1** record. After that, the CPU **111** proceeds to Step **112-05-3-4**.

At Step **112-05-3-4**, the CPU **111** fills the Disk Slot **121-3** of the newly allocated page with “0” data in order to format the page, except for page areas having existing data stored therein. After that, the CPU **111** proceeds to Step **112-05-3-5**.

At Step **112-05-3-5**, the CPU **111** checks Virtual Volume Page Management Table **112-13** to determine whether or not the page of the slot has already been allocated. If the page has already been allocated, then the CPU **111** proceeds to Step **112-05-3-8**. If the page has not been allocated yet, then the CPU **111** proceeds to Step **112-05-3-6**.

At Step **112-05-3-6**, the CPU **111** fills the Cache Slot **112-20-1** of Virtual Volume Page **140-1** with “0” data, except for areas having existing data stored therein. After that, the CPU **111** proceeds to Step **112-05-3-7**.

At Step **112-05-3-7**, the CPU **111** invokes the Compression Program **112-06-1** in order to compress the Virtual Volume Page **140-1**. After the completion of the Step **112-05-3-7**, the CPU **111** proceeds to Step **112-05-3-11**.

At Step **112-05-3-8**, the CPU **111** calls the Cache Staging Program **112-05-2** to stage and merge the page. After the completion of the Step **112-05-3-8**, the CPU **111** proceeds to Step **112-05-3-9**.

## 16

At Step **112-05-3-9**, the CPU **111** calls the Compression Program **112-06-1** in order to compress the Virtual Volume Page **140-1**. After the completion of the Step **112-05-3-9**, the CPU **111** proceeds to Step **112-05-3-10**.

At Step **112-05-3-10**, the CPU **111** dis-enrolls the current allocated Capacity Pool Page **121-2** from Virtual Volume Page Management Table **112-13** and dis-enrolls the current allocated Virtual Volume Page **140-1** from Capacity Pool Page Management Table **112-17** and appropriately increases the Deleted Capacity Information **112-16-04**. After that, the CPU **111** proceeds to Step **112-05-3-11**.

At Step **112-05-3-11**, the CPU **111** registers the Virtual Volume Page **140-1** into the Current Using Chunk Information **112-12-05**. The size of the registered page is the compressed page size. If the free area of Virtual Volume Page **140-1** that Current Using Chunk Information **112-12-05** refers to is less than Virtual Volume Page **140-1** size, CPU **111** links this Virtual Volume Page **140-1** to “Used Chunk Queue” of Capacity Pool Element Management Table **112-15**, and obtains a new one form “Free Chunk Queue”. After that, the CPU **111** registers Capacity Pool Page **121-2** into Virtual Volume Page Management table **112-13**. The size of the registered page is the compressed page size. After that, the CPU **111** proceeds to Step **112-05-3-4** and Step **112-05-3-12**.

At Step **112-05-3-12**, the CPU **111** checks whether or not the page of the slot needs to be encrypted. If the corresponding value in the Volume Type Information column **112-12-04** is “Encrypted” or “Encrypted & Compressed”, then the CPU **111** determines that the page of the slot needs to be encrypted. If the page of the slot needs to be encrypted, then the CPU **111** proceeds to Step **112-05-3-13**. If the page of the slot doesn’t need to be encrypted, then the CPU **111** proceeds to Step **112-05-3-14**.

At Step **112-05-3-13**, the CPU **111** calls the Encrypt Program **112-06-1** to encrypt the slot(s). After the completion of the Step **112-05-3-8**, the CPU **111** proceeds to Step **112-05-3-14**.

At Step **112-05-3-14**, the CPU **111** checks whether or not the slots are needed to make parity data. If the RAID Level Information is “5” or “6”, the CPU **111** determines that the slots are needed to make parity data. If it is determined that the slots are needed to make parity data, then the CPU **111** proceeds to Step **112-05-3-15**. If the slots are not needed to make parity data, then the CPU **111** proceeds to Step **112-05-3-16**.

At Step **112-05-3-15**, the CPU **111** makes parity data from Disk Slots **121-3** in the same stripe line, and stores the parity data in Cache Slot **112-20-1**. After that, the CPU **111** proceeds to Step **112-05-3-16**.

At Step **112-05-3-16**, the CPU **111** transfers Cache Slots **112-20-1** to Disk Slots **121-3** (if the disks are arranged in a RAID1 configuration, the CPU **111** transfers the Cache Slots **112-20-1** to two Slots **121-3**), and after the transfer, the CPU **111** links the Cache Slots **112-20-1** to the “Clean” queue of Queue Index Pointer column **112-18-12**. After that, the CPU **111** terminates the Destaging Program **112-05-3**.

FIG. **33** illustrates an exemplary embodiment of an operational flow chart of the Compression Program **112-06-1**. Upon invocation, the Compression Program **112-06-1** is provided with a page for compression. The Compression Program **112-06-1** may include one or more of the following steps.

At Step **112-06-1-1**, the CPU **111** reads the Cache Slots **112-20-1** of the page, compresses the page, and stores the compressed page in the Buffer Area **112-21**. Additionally, the compressed page includes a compression management infor-



mation, for example, compression dictionary information and check sum information. After that, the CPU 111 proceeds to Step 112-06-1-2.

At Step 112-06-1-2, the CPU 111 sets the pointer to a first slot number of the compressed page in the Buffer Area 112-21. After that, the CPU 111 proceeds to Step 112-06-1-6.

At Step 112-06-1-6, the CPU 111 compares the compressed data size and the virtual volume page size. If the size of the compressed data is equal or larger than the virtual volume size, then the CPU 111 proceeds to Step 112-06-1-7, otherwise the CPU 111 proceeds to Step 112-06-1-3.

At Step 112-06-1-7, the CPU 111 copies the source page data in the Cache Slots 112-20-1 and overwrites the Buffer Area 112-21. After that, the CPU 111 proceeds to Step 112-06-1-3.

At Step 112-06-1-3, the CPU 111 transfers the compressed slot from Buffer Area 112-21 to Cache Slot 112-20-1 of Capacity Pool Slot 121-3. After that, the CPU 111 proceeds to Step 112-06-1-4.

At Step 112-06-1-4, the CPU 111 determines whether the pointer has reached the last slot of the compressed page in the Buffer Area 112-21. If the pointer has reached the last slot, then the CPU 111 terminates the Compress Program 112-06-1. If the pointer has not reached the last slot, then the CPU 111 proceeds to Step 112-06-1-5.

At Step 112-06-1-5, the CPU 111 sets the pointer to the next slot. After that, the CPU 111 returns to Step 112-06-1-3.

FIG. 34 illustrates an exemplary embodiment of a flow chart of the Encryption Program 112-07-1. Upon invocation, the Encryption Program 112-07-1 is provided with a slot for decryption. In one embodiment, the Encryption Program 112-07-1 includes one or more of the following steps.

At Step 112-07-1-1, the CPU 111 reads the Cache Slot 112-20-1 of the Virtual Volume Slot 140-2, encrypts the page, and stores the encrypted page in the Buffer Area 112-21. After that, the CPU 111 proceeds to Step 112-07-1-2.

At step 112-07-1-2 the CPU 111 copies the encrypted slot in Buffer Area 112-21 to the Cache Slots 112-20-1 of the Disk Slot 121-3. After that, the CPU 111 terminates the Decryption Program 112-07-1.

FIG. 35 illustrates an exemplary embodiment of a flow chart of the Capacity Pool Management Program 112-08. The Capacity Pool Management Program 112-08 may include one or more of the following steps. At Step 112-08-1, the CPU 111 searches for the records of the Capacity Pool Chunk Management Table 112-16 that are linked to the "Used Chunk" queue indexed by Capacity Pool Element Management Table 112-15. The CPU 111 seeks the Deleted Capacity Information 112-16-04 and checks whether the respective value is more than 0, upon which the CPU 111 labels this chunk as "partially deleted chunk". If the CPU 111 finds the "partially deleted chunk", then the CPU 111 proceeds to Step 112-08-2. If the CPU 111 does not find the "partially deleted chunk" then the CPU 111 returns to Step 112-08-1.

At Step 112-08-2, the CPU 111 obtains the Capacity Pool Chunk Management Table 112-16 records that are linked to "Free Chunk" queue indexed by the Capacity Pool Element Management Table 112-15 to allocate new Capacity Pool Chunk 121-1. After that, the CPU 111 proceeds to Step 112-08-3.

At step 112-08-3, the CPU 111 sets the pointer A to first slot of the current allocated chunk and sets the pointer B to first slot of the newly allocated chunk. Thereafter, the CPU 111 proceeds to Step 112-08-4.

At Step 112-08-4, the CPU 111 determines whether or not the slot is in the deleted page of the chunk. To this end, the CPU 111 reads the Capacity Pool Page Management Table

112-17. After that, the CPU 111 calculates page offset by sum of Capacity Pool Page Size 112-17-1 and checks the parameter of Virtual Volume Page Number 112-17-02. If the parameter of Virtual Volume Page Number 112-17-02 is "NULL" then the CPU 111 proceeds to 112-08-6. If the parameter of Virtual Volume Page Number 112-17-02 is not "NULL" then the CPU 111 proceeds to step 112-08-5.

At Step 112-08-5, the CPU 111 copies the data from the slot indicated by the pointer A to the slot indicated by the pointer B. The CPU 111 sets the pointer B to point to the next slot of the newly allocated chunk. After that, the CPU 111 proceeds to Step 112-08-6.

At Step 112-08-6, the CPU 111 checks the pointer A. If the pointer A has reached to the last slot of the current chunk, then the CPU 111 proceeds to Step 112-08-8. If pointer A has not reached to last slot of the current chunk, then the CPU 111 proceeds to Step 112-08-7.

At Step 112-08-7, the CPU 111 sets the pointer A to the next slot of the current chunk. After that, the CPU 111 returns to Step 112-08-4.

At Step 112-08-8, the CPU 111 changes the Virtual Volume Page 140-1 addresses to the slots data copied from the Capacity Pool Page Management Table 112-17. The CPU 111 also changes Virtual Volume Page Management table to newly copied Capacity Pool Page 121-1 addresses and sizes. After that, the CPU 111 proceeds to Step 112-08-9.

Finally, at Step 112-08-9, the CPU 111 sets the current chunk to "Free Chunk" queue indexed by the Capacity Pool Element Management Table 112-15 to allocate new Capacity Pool Chunk 121-1. After that, the CPU 111 returns to Step 112-08-1.

#### Exemplary Computer Platform

FIG. 36 is a block diagram that illustrates an embodiment of a computer/server system 3600 upon which an embodiment of the inventive methodology may be implemented. The system 3600 includes a computer/server platform 3601, peripheral devices 3602 and network resources 3603.

The computer platform 3601 may include a data bus 3604 or other communication mechanism for communicating information across and among various parts of the computer platform 3601, and a processor 3605 coupled with bus 3601 for processing information and performing other computational and control tasks. Computer platform 3601 also includes a volatile storage 3606, such as a random access memory (RAM) or other dynamic storage device, coupled to bus 3604 for storing various information as well as instructions to be executed by processor 3605. The volatile storage 3606 also may be used for storing temporary variables or other intermediate information during execution of instructions by processor 3605. Computer platform 3601 may further include a read only memory (ROM or EPROM) 3607 or other static storage device coupled to bus 3604 for storing static information and instructions for processor 3605, such as basic input-output system (BIOS), as well as various system configuration parameters. A persistent storage device 3608, such as a magnetic disk, optical disk, or solid-state flash memory device is provided and coupled to bus 3601 for storing information and instructions.

Computer platform 3601 may be coupled via bus 3604 to a display 3609, such as a cathode ray tube (CRT), plasma display, or a liquid crystal display (LCD), for displaying information to a system administrator or user of the computer platform 3601. An input device 3610, including alphanumeric and other keys, is coupled to bus 3601 for communicating information and command selections to processor 3605. Another type of user input device is cursor control device 3611, such as a mouse, a trackball, or cursor direction

keys for communicating direction information and command selections to processor **3604** and for controlling cursor movement on display **3609**. This input device typically has two degrees of freedom in two axes, a first axis (e.g., x) and a second axis (e.g., y), that allows the device to specify positions in a plane.

An external storage device **3612** may be connected to the computer platform **3601** via bus **3604** to provide an extra or removable storage capacity for the computer platform **3601**. In an embodiment of the computer system **3600**, the external removable storage device **3612** may be used to facilitate exchange of data with other computer systems.

The invention is related to the use of computer system **3600** for implementing the techniques described herein. In an embodiment, the inventive system may reside on a machine such as computer platform **3601**. According to one embodiment of the invention, the techniques described herein are performed by computer system **3600** in response to processor **3605** executing one or more sequences of one or more instructions contained in the volatile memory **3606**. Such instructions may be read into volatile memory **3606** from another computer-readable medium, such as persistent storage device **3608**. Execution of the sequences of instructions contained in the volatile memory **3606** causes processor **3605** to perform the process steps described herein. In alternative embodiments, hard-wired circuitry may be used in place of or in combination with software instructions to implement the invention. Thus, embodiments of the invention are not limited to any specific combination of hardware circuitry and software.

The term "computer-readable medium" as used herein refers to any medium that participates in providing instructions to processor **3605** for execution. The computer-readable medium is just one example of a machine-readable medium, which may carry instructions for implementing any of the methods and/or techniques described herein. Such a medium may take many forms, including but not limited to, non-volatile media, volatile media, and transmission media. Non-volatile media includes, for example, optical or magnetic disks, such as storage device **3608**. Volatile media includes dynamic memory, such as volatile storage **3606**. Transmission media includes coaxial cables, copper wire and fiber optics, including the wires that comprise data bus **3604**. Transmission media can also take the form of acoustic or light waves, such as those generated during radio-wave and infrared data communications.

Common forms of computer-readable media include, for example, a floppy disk, a flexible disk, hard disk, magnetic tape, or any other magnetic medium, a CD-ROM, any other optical medium, punchcards, papertape, any other physical medium with patterns of holes, a RAM, a PROM, an EPROM, a FLASH-EPROM, a flash drive, a memory card, any other memory chip or cartridge, a carrier wave as described hereinafter, or any other medium from which a computer can read.

Various forms of computer readable media may be involved in carrying one or more sequences of one or more instructions to processor **3605** for execution. For example, the instructions may initially be carried on a magnetic disk from a remote computer. Alternatively, a remote computer can load the instructions into its dynamic memory and send the instructions over a telephone line using a modem. A modem local to computer system **3600** can receive the data on the telephone line and use an infra-red transmitter to convert the data to an infra-red signal. An infra-red detector can receive the data carried in the infra-red signal and appropriate circuitry can place the data on the data bus **3604**. The bus **3604** carries the data to the volatile storage **3606**, from which

processor **3605** retrieves and executes the instructions. The instructions received by the volatile memory **3606** may optionally be stored on persistent storage device **3608** either before or after execution by processor **3605**. The instructions may also be downloaded into the computer platform **3601** via Internet using a variety of network data communication protocols well known in the art.

The computer platform **3601** also includes a communication interface, such as network interface card **3613** coupled to the data bus **3604**. Communication interface **3613** provides a two-way data communication coupling to a network link **3614** that is connected to a local network **3615**. For example, communication interface **3613** may be an integrated services digital network (ISDN) card or a modem to provide a data communication connection to a corresponding type of telephone line. As another example, communication interface **3613** may be a local area network interface card (LAN NIC) to provide a data communication connection to a compatible LAN. Wireless links, such as well-known 802.11a, 802.11b, 802.11g and Bluetooth may also be used for network implementation. In any such implementation, communication interface **3613** sends and receives electrical, electromagnetic or optical signals that carry digital data streams representing various types of information.

Network link **3613** typically provides data communication through one or more networks to other network resources. For example, network link **3614** may provide a connection through local network **3615** to a host computer **3616**, or a network storage/server **3617**. Additionally or alternatively, the network link **3613** may connect through gateway/firewall **3617** to the wide-area or global network **3618**, such as an Internet. Thus, the computer platform **3601** can access network resources located anywhere on the Internet **3618**, such as a remote network storage/server **3619**. On the other hand, the computer platform **3601** may also be accessed by clients located anywhere on the local area network **3615** and/or the Internet **3618**. The network clients **3620** and **3621** may themselves be implemented based on the computer platform similar to the platform **3601**.

Local network **3615** and the Internet **3618** both use electrical, electromagnetic or optical signals that carry digital data streams. The signals through the various networks and the signals on network link **3614** and through communication interface **3613**, which carry the digital data to and from computer platform **3601**, are exemplary forms of carrier waves transporting the information.

Computer platform **3601** can send messages and receive data, including program code, through the variety of network (s) including Internet **3618** and LAN **3615**, network link **3614** and communication interface **3613**. In the Internet example, when the system **3601** acts as a network server, it might transmit a requested code or data for an application program running on client(s) **3620** and/or **3621** through Internet **3618**, gateway/firewall **3617**, local area network **3615** and communication interface **3613**. Similarly, it may receive code from other network resources.

The received code may be executed by processor **3605** as it is received, and/or stored in persistent or volatile storage devices **3608** and **3606**, respectively, or other non-volatile storage for later execution. In this manner, computer system **3601** may obtain application code in the form of a carrier wave.

It should be noted that the present invention is not limited to any specific firewall system. The inventive policy-based content processing system may be used in any of the three firewall operating modes and specifically NAT, routed and transparent.

Finally, it should be understood that processes and techniques described herein are not inherently related to any particular apparatus and may be implemented by any suitable combination of components. Further, various types of general purpose devices may be used in accordance with the teachings described herein. It may also prove advantageous to construct specialized apparatus to perform the method steps described herein. The present invention has been described in relation to particular examples, which are intended in all respects to be illustrative rather than restrictive. Those skilled in the art will appreciate that many different combinations of hardware, software, and firmware will be suitable for practicing the present invention. For example, the described software may be implemented in a wide variety of programming or scripting languages, such as Assembler, C/C++, perl, shell, PHP, Java, etc.

Moreover, other implementations of the invention will be apparent to those skilled in the art from consideration of the specification and practice of the invention disclosed herein. Various aspects and/or components of the described embodiments may be used singly or in any combination in the computerized storage system with thin provisioning and compression functionality. It is intended that the specification and examples be considered as exemplary only, with a true scope and spirit of the invention being indicated by the following claims.

What is claimed is:

1. A data storage system comprising:
  - at least one storage device; and
  - a controller, comprising a cache memory and configured to manage a capacity pool comprising a plurality of storage regions and provide a plurality of virtual volumes having a plurality of virtual areas,
  - wherein one or more of the plurality of the storage regions are allocated to each of a plurality of first virtual areas in a first virtual volume of the plurality of virtual volumes from the capacity pool, wherein a compression function is not enabled for the first virtual volume of the plurality of virtual volumes, the number of the allocated one or more storage regions is a first value, and
  - wherein when the compression function is changed from being not enabled to being enabled for the first virtual volume of the plurality of virtual volumes, the controller is further configured to:
    - store data read from the allocated one or more storage regions to the cache memory for each of the first virtual areas in the first virtual volume of the plurality of virtual volumes;
    - compress the data in the cache memory for each of the first virtual areas in the first virtual volume of the plurality of virtual volumes;
    - decide whether to store the data in a compressed form for a particular first virtual area of the first virtual areas in the first virtual volume of the plurality of virtual volumes based on the compression step in the cache memory;
    - if the controller decided to store the data in the compressed form for the particular first virtual area, change the number of the allocated one or more storage regions, which are allocated to the particular first virtual area, to be smaller than the first value; and
    - if the controller decided not to store the data in the compressed form, maintain the number of the allocated one or more storage regions, which are allocated to the particular first virtual area.
2. The data storage system according to claim 1, wherein the controller is configured to:

receive a read request for certain data;  
 read the requested certain data from the cache memory if it is stored in the cache memory;  
 read the requested certain data from the at least one storage device if it is not stored in the cache memory; and  
 decompress the requested certain data if the requested certain data is in the compressed form.

3. The data storage system according to claim 1, wherein the controller is further configured to receive a request to specify that the compression function for the first virtual volume is to be changed from being not enabled to being enabled.

4. The data storage system according to the claim 1, wherein the controller is further configured to:
 

- receive a write request targeted to a second virtual area in a second virtual volume of the plurality of virtual volumes for writing a second data, the second virtual volume having a compression function being not enabled;
- allocate a second one or more of the plurality of storage regions from the capacity pool to the second virtual area, the number of the allocated second one or more storage regions is the first value; and
- store the second write data to an area of the storage corresponding to the allocated second one or more storage regions.

5. A storage system comprising:
 

- a plurality of storage devices; and
- a storage controller configured to manage a storage pool including a plurality of storage regions on the plurality of storage devices, provide a plurality of virtual volumes including a first virtual volume which has a plurality of first virtual areas, wherein a compression function is not enabled for the first virtual volume of the plurality of virtual volumes, and allocate one or more storage regions to each of the first virtual areas in the first virtual volume of the plurality of virtual volumes from the storage pool, the number of the allocated one or more storage regions is a first value, and

 wherein when the compression function is changed from being not enabled to being enabled for the first virtual volume of the plurality of virtual volumes, the controller is further configured to:
 

- compress data read from the one or more storage regions which are allocated to each of the first virtual areas in the first virtual volume of the plurality of virtual volumes;
- decide whether to store the data in a compressed form based on the compression for each first virtual area in the first virtual volume of the plurality of virtual volumes;
- if the controller decided to store the data in the compressed form for a particular first virtual area of the first virtual areas in the first virtual volume of the plurality of virtual volumes, change the number of the one or more storage regions, which are allocated to the particular first virtual area, to be smaller than the first value; and
- if the controller decided not to store the data in the compressed form for the particular first virtual area, maintain the number of the one or more storage regions which are allocated to the particular first virtual area.

6. The storage system according to claim 5, wherein the storage controller is further configured to compare a size of the compressed form of the data and the size of the first virtual area to decide whether to store the data in the compressed form.

23

7. The storage system according to claim 5, wherein the storage controller is further configured to compare a size of the compressed form of the data and a size of an uncompressed form of the data to decide whether to store the data in the compressed form.

8. The storage system according to claim 5, wherein the storage controller, in response to receiving a read request for certain data, is further configured to, if the certain data is stored in the compressed form:

read the compressed form of the certain data from the one or more storage regions allocated to a certain first virtual area which stores the certain data;

decompress the compressed form of the certain data as decompressed data; and

transfer the decompressed data as a response to the read request.

9. A data processing method for a storage controller being coupled to a plurality of storage devices, the data processing method comprising:

providing a plurality of virtual volumes including a first virtual volume associated with a storage pool provided by the plurality of storage devices and having a plurality of storage regions, wherein a compression function is not enabled for the first virtual volume of the plurality of virtual volumes;

allocating one or more of the plurality of the storage regions to each of a plurality of first virtual areas in the first virtual volume of the plurality of virtual volumes from the storage pool, the number of the allocated one or more storage regions is a first value;

upon receiving a request to change the compression function from being not enabled to being enabled for the first virtual volume of the plurality of virtual volumes, further performing the steps of:

24

compressing the data read from the allocated one or more storage regions which are allocated to each of the first virtual areas in the first virtual volume of the plurality of virtual volumes;

deciding whether to store the data in a compressed form based on the compression of the data read from the allocated one or more storage regions for each first virtual area in the first virtual volume of the plurality of virtual volumes;

if the controller decided to store the data in the compressed form for a particular first virtual area of the first virtual areas in the first virtual volume of the plurality of virtual volumes, changing the number of the allocated one or more storage regions, which are allocated to the particular first virtual area, to be smaller than the first value; and

if the controller decided not to store the data in the compressed form for the particular first virtual area, maintaining the number of the allocated one or more storage regions which are allocated to the particular first virtual area.

10. The data processing method according to claim 9, wherein the step of deciding whether to store the data in the compressed form further comprises comparing a size of the compressed form of the data and a size of the first virtual area to decide whether to store the data in the compressed form.

11. The data processing method according to claim 9, wherein the step of deciding whether to store the data in the compressed form further comprises comparing a size of the compressed form of the data and a size of uncompressed form of the data to decide whether to store the data in the compressed form.

\* \* \* \* \*